

22307

# AIRPORT DIAGRAM

COBB COUNTY INTL/MCCOLLUM FLD (RYY)

AL-6424 (FAA)

ATLANTA, GEORGIA

ATIS  
 128.125  
 McCOLLUM TOWER ★  
 125.9  
 GND CON  
 119.0  
 CLNC DEL  
 119.0  
 121.0 (When twr closed)  
 268.7 (When twr closed)

FIELD  
 ELEV  
 1040

D

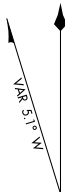
  
 JANUARY 2020  
 ANNUAL RATE OF CHANGE  
 0.1° W

SE-4, 22 FEB 2024 to 21 MAR 2024

SE-4, 22 FEB 2024 to 21 MAR 2024

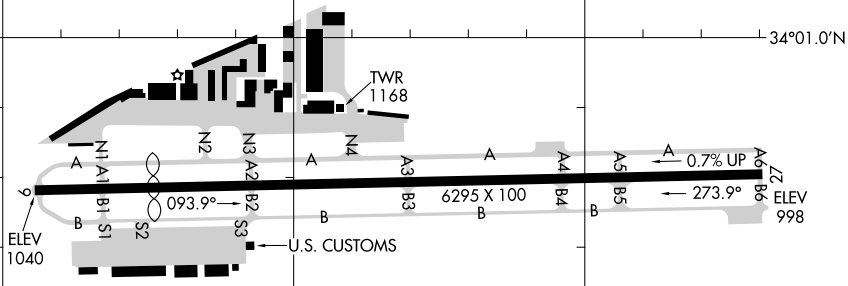

RWY 09-27  
 PCN 50 R/C/W/T

CAUTION: BE ALERT TO RUNWAY CROSSING CLEARANCES.  
READBCK OF ALL RUNWAY HOLDING INSTRUCTIONS IS REQUIRED.

84°36.5'W

84°36.0'W

84°35.5'W

34°00.5'N

34°01.0'N

34°01.5'N

# AIRPORT DIAGRAM

22307

ATLANTA, GEORGIA  
COBB COUNTY INTL/MCCOLLUM FLD (RYY)

LOC/DME I-RYY <b>111.9</b> Chan <b>56</b>	APP CRS <b>273°</b>	Rwy Idg TDZE Apt Elev	<b>5374</b> <b>1011</b> <b>1040</b>
---	------------------------	-----------------------------	---

# ILS or LOC RWY 27

COBB COUNTY INTL/MCCOLLUM FLD (RYY)

DME required. RADAR required for procedure entry.		MALSF 	MISSED APPROACH: Climb to 1600 then climbing right turn to 3500 on heading 300° and on RMG VORTAC R-108 to TIPPY/RMG 11 DME and hold.
Inop table does not apply to S-ILS 27.			

ATIS <b>128.125</b>	ATLANTA APP CON <b>121.0 268.7</b>	MCCOLLUM TOWER ★ <b>125.9 (CTAF) 0</b>	GND CON <b>119.0</b>	CLNC DEL <b>119.0</b>	CLNC DEL <b>121.0 268.7</b> (When twr closed)	UNICOM <b>122.7</b>
------------------------	---------------------------------------	---	-------------------------	--------------------------	---	------------------------

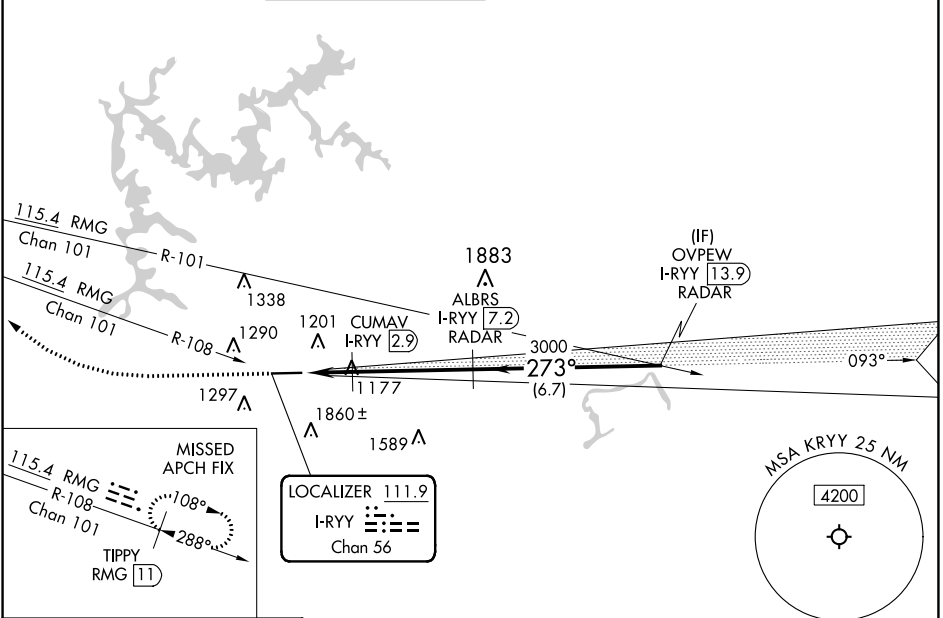

SE-4, 22 FEB 2024 to 21 MAR 2024

SE-4, 22 FEB 2024 to 21 MAR 2024

ELEV 1040	<b>D</b>	TDZE 1011
-----------	----------	-----------

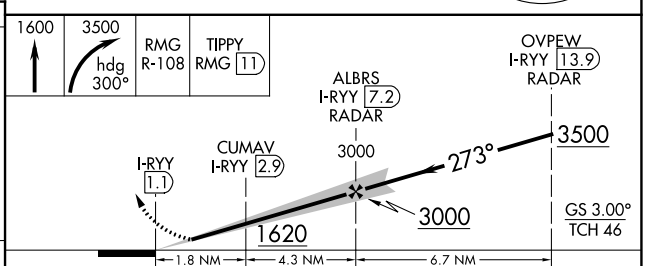
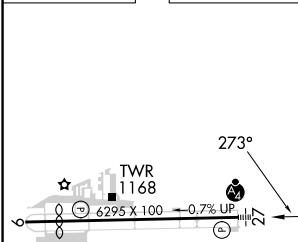

CATEGORY	A	B	C	D
S-ILS 27	1211-3/4 200 (200-3/4)			
S-LOC 27	1620-3/4	609 (600-3/4)	1620-1 1/2	609 (600-1 1/2)
<b>C</b> CIRCLING	1800-1	760 (800-1)	2180-3	1140 (1200-3)
CUMAV FIX MINIMUMS				
S-LOC 27	1480-3/4	469 (500-3/4)	1480-1 1/8	469 (500-1 1/8)
<b>C</b> CIRCLING	1800-1	760 (800-1)	2180-3	1140 (1200-3)

HIRL Rwy 9-27 **0**

FAF to MAP 6.1 NM

Knots	60	90	120	150	180
Min:Sec	6:06	4:04	3:03	2:26	2:02

WAAS CH <b>97308</b> <b>W27A</b>	APP CRS <b>273°</b>	Rwy Idg TDZE <b>1011</b> Apt Elev <b>1040</b>	<b>5374</b>
--	------------------------	---	-------------

# RNAV (GPS) RWY 27

COBB COUNTY INTL/MCCOLLUM FLD (RYY)

RNP APCH-GPS.					MALSF		MISSED APPROACH: Climb to 3500 direct UPHAH and hold.	
Inop table does not apply to LPV. For uncompensated Baro-VNAV systems, LNAV/VNAV NA below -17°C or above 54°C. For inop ALS, increase LNAV/VNAV all Cats and LNAV Cats C and D visibility to 1½ SM. Circling Rwy 9 NA at night.								
ATIS <b>128.125</b>	ATLANTA APP CON <b>121.0 268.7</b>	MCCOLLUM TOWER ★ <b>125.9 (CTAF) 0</b>	GND CON <b>119.0</b>	CLNC DEL <b>119.0</b>	CLNC DEL <b>121.0 268.7</b> (When twr closed)		UNICOM <b>122.7</b>	

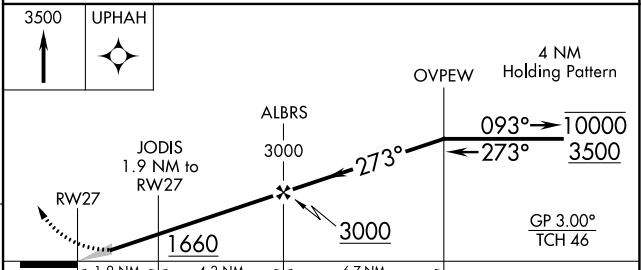
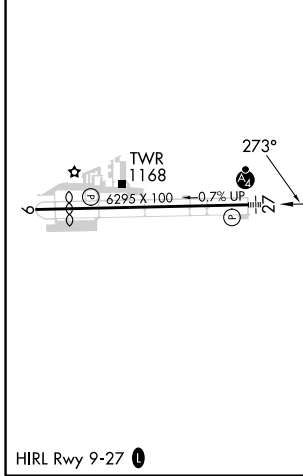
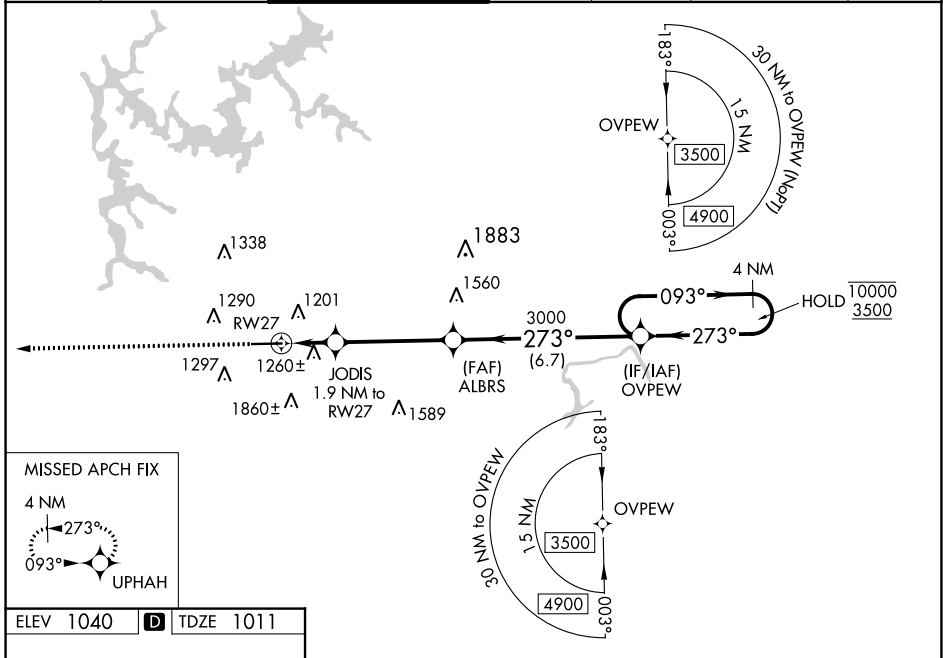

ELEV	1040	<b>D</b>	TDZE	1011
3500	UPHAH			
CATEGORY	A	B	C	D
LPV DA	1211-¾		200 (200-¾)	
LNAV/VNAV DA	1520-1¼		509 (500-1¼)	
LNAV MDA	1520-¾	509 (500-¾)	1520-1¼	509 (500-1¼)
<b>C</b> CIRCLING	1800-1	760 (800-1)	2180-3	1140 (1200-3)

SE-4, 22 FEB 2024 to 21 MAR 2024

SE-4, 22 FEB 2024 to 21 MAR 2024

WAAS CH <b>61144</b> <b>W09A</b>	APP CRS <b>093°</b>	Rwy ldg TDZE Apt Elev	<b>5233</b> <b>1028</b> <b>1040</b>
--	------------------------	-----------------------------	---

# RNAV (GPS) RWY 9

COBB COUNTY INTL/MCCOLLUM FLD (RYY)

RNP APCH-GPS.		MISSED APPROACH: Climbing left turn to 3500 direct UPHAH and hold.				
▼ ▲ Rwy 9 helicopter visibility reduction below 1 SM NA.						
ATIS <b>128.125</b>	ATLANTA APP CON <b>121.0 268.7</b>	MCCOLLUM TOWER ★ <b>125.9 (CTAF) 0</b>	GND CON <b>119.0</b>	CLNC DEL <b>119.0</b>	CLNC DEL <b>121.0 268.7</b> (When twr closed)	UNICOM <b>122.7</b>

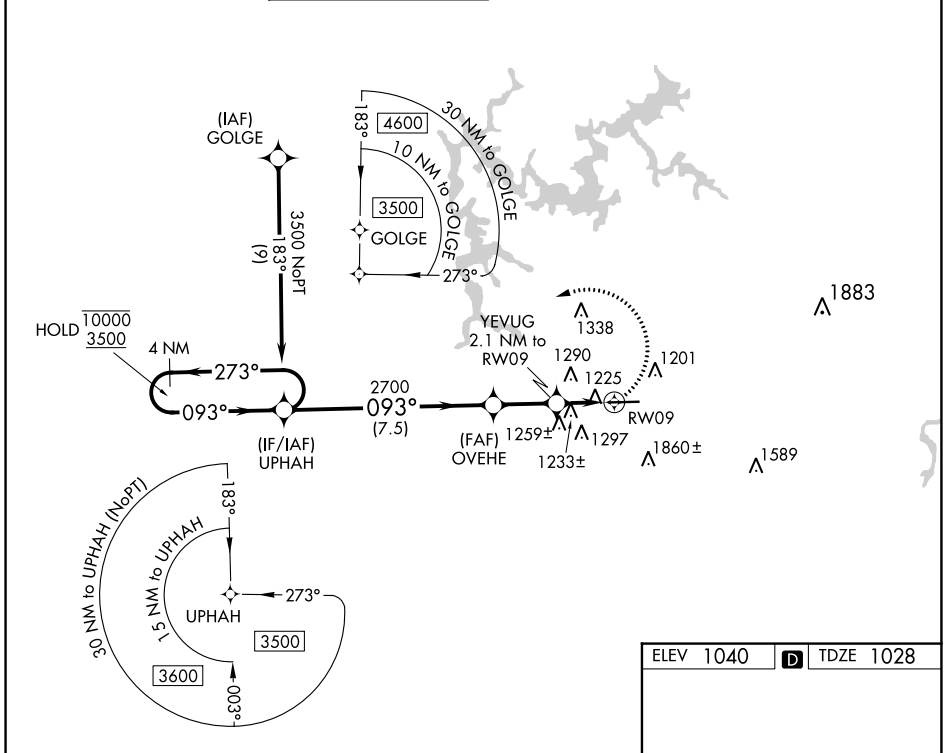

SE-4, 22 FEB 2024 to 21 MAR 2024

SE-4, 22 FEB 2024 to 21 MAR 2024

ELEV 1040	TDZE 1028
-----------	-----------

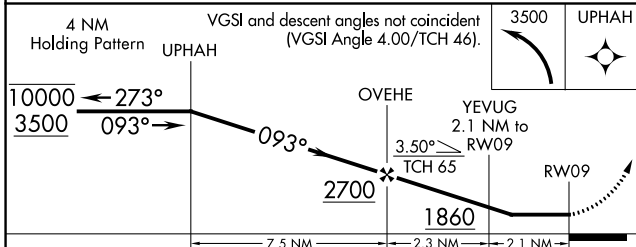

CATEGORY	A	B	C	D
LP MDA	1480-1	452 (500-1)	1480-1 $\frac{3}{8}$	452 (500-1 $\frac{3}{8}$ )
LNAV MDA	1500-1	472 (500-1)	1500-1 $\frac{3}{8}$	472 (500-1 $\frac{3}{8}$ )
CIRCLING	1800-1	760 (800-1)	2180-3	1140 (1200-3)

HIRL Rwy 9-27

VORTAC RMG <b>115.4</b> Chan 101	APP CRS <b>108°</b>	Rwy ldg <b>5233</b> TDZE <b>1028</b> Apt Elev <b>1040</b>
--	------------------------	---

# VOR/DME RWY 9

COBB COUNTY INTL/MCCOLLUM FLD (RYY)

**⚠** Helicopter visibility reduction below 1 SM NA. When local altimeter setting not received, use Hartsfield-Jackson Atlanta Intl altimeter setting and increase all MDA 60 feet and S-9 Cat A/C/D visibilities ¼ mile. Night landing: Rwy 9 NA.

MISSED APPROACH: Climbing left turn to 3000 via heading 240° and RMG R-108 to KAILA/21 DME and hold.

ATIS <b>128.125</b>	ATLANTA APP CON <b>121.0 268.7</b>	MCCOLLUM TOWER ★ <b>125.9 (CTAF) 0</b>	GND CON <b>119.0</b>	CLNC DEL <b>119.0</b>	CLNC DEL <b>121.0 268.7</b> (When twr closed)	UNICOM <b>122.7</b>
------------------------	---------------------------------------	---	-------------------------	--------------------------	---	------------------------

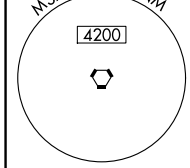
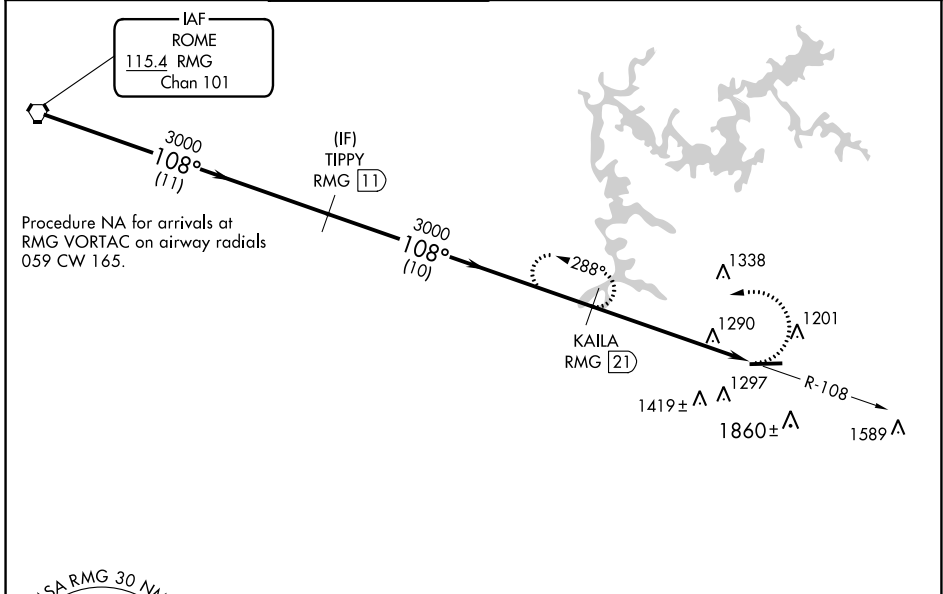

ELEV 1040	<b>D</b> TDZE 1028
-----------	--------------------

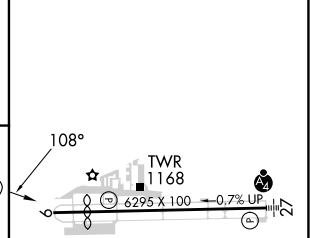
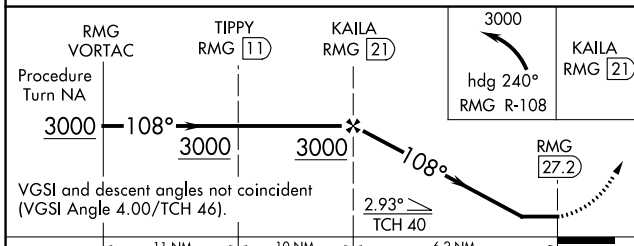

CATEGORY	A	B	C	D
S-9	1900-1 872 (900-1)	1900-1¼ 872 (900-1¼)	1900-2½ 872 (900-2½)	1900-2¾ 872 (900-2¾)
CIRCLING	1900-1¼	860 (900-1¼)	2220-3	1180 (1200-3)

HIRL Rwy 9-27 **0**

# VOR/DME RWY 9

SE-4, 22 FEB 2024 to 21 MAR 2024

SE-4, 22 FEB 2024 to 21 MAR 2024

INSTRUMENT APPROACH PROCEDURE CHARTS

**IFR ALTERNATE AIRPORT MINIMUMS**

Pilots must review the IFR Alternate Minimums Notes to determine alternate airport suitability.

**△**NA designation on the approach chart means that pilots may not use that approach as an alternate due to unmonitored facility, absence of weather reporting service, or lack of adequate navigation coverage. Approaches with the **△**NA designation are not listed in this section. **△** designation on the approach chart indicates that the approach procedure has non-standard minimums (for aircraft other than helicopters) or restrictions (for all users) for its use as an alternate.

Alternate Minima (ref: 14 CFR 91.169)

	Precision Approach	Non-Precision Approach
Standard	<b>600-2</b>	<b>800-2</b>
<b>△</b> Non-Standard or restrictions	As indicated below	As indicated below
Helicopters	For the selected approach: Ceiling: 200' above published ceiling Visibility: the greater of 1 SM visibility or the published visibility	
US Military (USA/USN/USAF)	See Service Regulations	

**Note:** For alternate airport flight planning purposes, precision approach operations include: ILS, PAR, and GLS, and Non-Precision approach operations include: NDB, VOR, LOC, TACAN, LDA, SDF, ASR, RNAV (GPS) and RNAV (RNP).

NAME ALTERNATE MINIMUMS

**ALABASTER, AL**

SHELBY COUNTY (EET).....RNAV (GPS) Rwy 16  
RNAV (GPS) Rwy 34  
NA when local weather not available.  
Category C, 800-2¼; Category D, 1000-3.

**ALBANY, GA**

SOUTHWEST GEORGIA  
RGNL (ABY).....ILS or LOC Rwy 5<sup>12</sup>  
RNAV (GPS) Rwy 5<sup>3</sup>  
RNAV (GPS) Rwy 17<sup>3</sup>  
RNAV (GPS) Rwy 23<sup>3</sup>  
RNAV (GPS) Rwy 35<sup>3</sup>  
VOR Rwy 17<sup>3</sup>

<sup>1</sup>NA when control tower closed.  
<sup>2</sup>LOC, Category C, 800-2¼; Category D, 800-2½.  
<sup>3</sup>Category C, 800-2¼; Category D, 800-2½.

**ALBERTVILLE, AL**

ALBERTVILLE RGNL/THOMAS J  
BRUMLIK FLD (8A0).....RNAV (GPS) Rwy 5  
RNAV (GPS) Rwy 23  
NA when local weather not available.

**ALEXANDER CITY, AL**

THOMAS C RUSSELL  
FLD (ALX).....RNAV (GPS) Rwy 18  
RNAV (GPS) Rwy 36  
Category C, 900-2¼; Category D, 900-2¾.

NAME ALTERNATE MINIMUMS

**ALMA, GA**

BACON  
COUNTY (AMG).....RNAV (GPS) Rwy 16  
RNAV (GPS) Rwy 34  
NA when local weather not available.  
Category C, 800-2¼; Category D, 800-2½.

**ANDALUSIA-OPP, AL**

SOUTH ALABAMA RGNL AT BILL BENTON  
FLD (79J).....COPTER NDB Rwy 29  
NDB-A  
RNAV (GPS) Rwy 11  
RNAV (GPS) Rwy 29  
NA when local weather not available.

**ANNISTON, AL**

ANNISTON  
RGNL (ANB).....ILS Y or LOC Y Rwy 5<sup>1</sup>  
ILS Z or LOC Z Rwy 5<sup>2</sup>  
RNAV (GPS) Rwy 5<sup>3</sup>  
RNAV (GPS) Rwy 23<sup>4</sup>

NA when local weather not available.  
<sup>1</sup>ILS, LOC, Categories A, B, 900-2; Category C, 900-2¼; Category D, 1300-3.  
<sup>2</sup>ILS, Categories A, B, 900-2; Category C, 900-2¼; Category D, 1300-3; LOC, Categories A, B, 900-2; Category C, 900-2¼.  
<sup>3</sup>Categories A, B, 900-2; Category C, 900-2¼; Category D, 1300-3.  
<sup>4</sup>Categories A, B, 900-2; Category C, 900-2¼; Category D, 1300-3.

22 FEB 2024 to 21 MAR 2024

22 FEB 2024 to 21 MAR 2024

NAME ALTERNATE MINIMUMS

**ATHENS, GA**

ATHENS/BEN  
EPPS (AHN).....**ILS or LOC/DME Rwy 27<sup>1</sup>**  
**RNAV (GPS) Rwy 2**  
**RNAV (GPS) Rwy 20**  
**RNAV (GPS) Rwy 27**  
**VOR Rwy 2**

NA when local weather not available.  
<sup>1</sup>Category D, 700-2.

**ATLANTA, GA**

ATLANTA RGNL FALCON  
FLD (FFC).....**ILS or LOC Rwy 31<sup>1</sup>**  
**RNAV (GPS) Rwy 13<sup>2</sup>**  
**RNAV (GPS) Rwy 31<sup>2</sup>**

NA when local weather not available.  
<sup>1</sup>LOC, Category D, 800-2 $\frac{1}{4}$ .  
<sup>2</sup>Category D, 800-2 $\frac{1}{4}$ .

ATLANTA  
SPEEDWAY (HMP).....**RNAV (GPS) Rwy 6**  
**RNAV (GPS) Rwy 24**

NA when local weather not available.  
Category C, 900-2 $\frac{1}{2}$ ; Category D, 900-2 $\frac{1}{4}$ .

COBB COUNTY INTL/MCCOLLUM  
FLD (RYY).....**ILS or LOC Rwy 27<sup>12</sup>**  
**RNAV (GPS) Rwy 9<sup>3</sup>**  
**RNAV (GPS) Rwy 27<sup>3</sup>**  
**VOR/DME Rwy 9<sup>4</sup>**

NA when local weather not available.  
<sup>1</sup>NA when control tower closed.  
<sup>2</sup>LOC, Categories C, D, 1200-3.  
<sup>3</sup>Categories C, D, 1200-3.  
<sup>4</sup>Categories A, B, 900-2;  
Categories C, D, 1200-3.

COVINGTON  
MUNI (CVC).....**RNAV (GPS) Rwy 10**  
**RNAV (GPS) Rwy 28**

NA when local weather not available.

DEKALB-  
PEACHTREE (PDK).....**ILS or LOC Rwy 21L<sup>123</sup>**  
**RNAV (GPS)-A<sup>4</sup>**  
**RNAV (GPS) Y Rwy 21L<sup>14</sup>**

<sup>1</sup>NA when local weather not available.  
<sup>2</sup>NA when control tower closed.  
<sup>3</sup>LOC, Category C, 900-2 $\frac{1}{2}$ ; Category D, 1100-3.  
<sup>4</sup>Category C, 900-2 $\frac{1}{2}$ ; Category D, 1100-3.

NAME ALTERNATE MINIMUMS

**ATLANTA, GA (CON'T)**

FULTON COUNTY EXEC/CHARLIE  
BROWN FLD (FTY).....**ILS or LOC Rwy 8<sup>1</sup>**  
**RNAV (GPS) Rwy 26<sup>2</sup>**  
**RNAV (GPS) Y Rwy 8<sup>3</sup>**

<sup>1</sup>LOC, Categories A, B, 900-2; Category C, 900-2 $\frac{1}{2}$ ; Category D, 900-3.  
<sup>2</sup>Category C, 900-2 $\frac{1}{2}$ ; Category D, 900-3.  
<sup>3</sup>Categories A, B, 900-2; Category C, 900-2 $\frac{1}{2}$ ; Category D, 900-3.

HARTSFIELD - JACKSON ATLANTA  
INTL (ATL).....**ILS or LOC Rwy 27L**  
LOC, Category C, 800-2 $\frac{1}{4}$ ; Category D, 800-2 $\frac{1}{4}$ .

NEWNAN COWETA  
COUNTY (CCO).....**ILS or LOC Rwy 33<sup>1</sup>**  
**RNAV (GPS) Rwy 15**  
**RNAV (GPS) Rwy 33**

NA when local weather not available.  
<sup>1</sup>NA when FBO closed.

PAULDING NORTHWEST  
ATLANTA (PUJ).....**ILS or LOC Rwy 31<sup>1</sup>**  
**RNAV (GPS) Rwy 31**

NA when local weather not available.  
<sup>1</sup>NA when Terminal Bldg closed.

**AUBURN, AL**

AUBURN UNIVERSITY  
RGNL (AUO).....**ILS or LOC Rwy 36<sup>1</sup>**  
**RNAV (GPS) Rwy 11<sup>2</sup>**  
**RNAV (GPS) Rwy 18<sup>2</sup>**  
**RNAV (GPS) Rwy 29<sup>2</sup>**  
**RNAV (GPS) Rwy 36<sup>2</sup>**

<sup>1</sup>NA when local weather not available.  
<sup>2</sup>Category D, 800-2 $\frac{1}{4}$ .

**AUGUSTA, GA**

AUGUSTA RGNL AT BUSH  
FLD (AGS).....**ILS or LOC Rwy 17<sup>12</sup>**  
**ILS or LOC Rwy 35<sup>12</sup>**  
**RNAV (GPS) Rwy 17<sup>3</sup>**  
**RNAV (GPS) Rwy 26<sup>3</sup>**  
**RNAV (GPS) Rwy 35<sup>3</sup>**  
**RNAV (GPS) Y Rwy 8<sup>3</sup>**  
**RNAV (GPS) Z Rwy 8<sup>3</sup>**

NA when local weather not available.  
<sup>1</sup>NA when control tower closed.  
<sup>2</sup>LOC, Category D, 800-2 $\frac{1}{2}$ .  
<sup>3</sup>Category D, 800-2 $\frac{1}{2}$ .

DANIEL FLD (DNL).....**NDB Rwy 11**  
**RNAV (GPS) Rwy 5<sup>1</sup>**  
**RNAV (GPS) Y Rwy 11<sup>2</sup>**  
**VOR/DME-B**

NA when local weather not available.  
<sup>1</sup>Categories A, B, C, D, 1100-4.  
<sup>2</sup>Categories C, D, 1000-3.

22 FEB 2024 to 21 MAR 2024

22 FEB 2024 to 21 MAR 2024

## NAME ALTERNATE MINIMUMS

**BAINBRIDGE, GA**

DECATUR COUNTY INDUSTRIAL  
AIR PARK (BGE).....RNAV (GPS) Rwy 9  
RNAV (GPS) Rwy 27

NA when local weather not available.  
Category D, 800-2¼.

**BAY MINETTE, AL**

BAY MINETTE  
MUNI (1R8).....RNAV (GPS) Rwy 8  
RNAV (GPS) Rwy 26

NA when local weather not available.

**BIRMINGHAM, AL**

BIRMINGHAM-SHUTTLESWORTH  
INTL (BHM).....RNAV (GPS) Rwy 36<sup>1</sup>  
RNAV (GPS) Y Rwy 6<sup>2</sup>

<sup>1</sup>Categories A, B, 900-2; Categories C, D, 900-2½.  
<sup>2</sup>Category D, 900-2¼.

**BLAKELY, GA**

EARLY COUNTY (BIJ).....RNAV (GPS) Rwy 5  
RNAV (GPS) Rwy 23

NA when local weather not available.  
Category D, 800-2¼.

**BLAIRSVILLE, GA**

BLAIRSVILLE (DZJ).....RNAV (GPS) Rwy 8  
NA when local weather not available.  
Category A, 1000-2; Category B, 1100-2;  
Category C, 1300-3.

**BRUNSWICK, GA**

BRUNSWICK GOLDEN  
ISLES (BQK).....ILS or LOC Rwy 7<sup>1</sup>  
RNAV (GPS) Rwy 7<sup>2</sup>  
RNAV (GPS) Rwy 25<sup>2</sup>  
VOR/DME-B <sup>2</sup>

NA when local weather not available.  
<sup>1</sup>LOC, Category D, 800-2½.  
<sup>2</sup>Category D, 800-2½.

**BUTLER, GA**

BUTLER  
MUNI (6A1).....RNAV (GPS) Rwy 1  
RNAV (GPS) Rwy 19

Category D, 800-2¼.

**CALHOUN, GA**

TOM B DAVID FLD (CZL).....RNAV (GPS) Rwy 17  
RNAV (GPS) Rwy 35

NA when local weather not available.  
Category C, 1000-2¾; Category D, 1000-3.

**CANON, GA**

FRANKLIN-HART (18A).....RNAV (GPS) Rwy 8<sup>1</sup>  
RNAV (GPS) Rwy 26

NA when local weather not available.  
<sup>1</sup>Category D, 800-2¼.

## NAME ALTERNATE MINIMUMS

**CANTON, GA**

CHEROKEE COUNTY  
RGNL (CNI).....RNAV (GPS) Rwy 5<sup>1</sup>  
RNAV (GPS) Rwy 23

NA when local weather not available.  
<sup>1</sup>Category D, 900-2¾.

**CARROLLTON, GA**

WEST GEORGIA RGNL - O V GRAY  
FLD (CTJ).....RNAV (GPS) Rwy 17  
RNAV (GPS) Rwy 35

NA when local weather not available.  
Category D, 900-2¾.

**CARTERSVILLE, GA**

CARTERSVILLE (VPC).....RNAV (GPS) Rwy 1<sup>1</sup>  
RNAV (GPS) Rwy 19<sup>1</sup>  
VOR-A<sup>2</sup>

NA when local weather not available.  
<sup>1</sup>Category B, 900-2; Category C, 1000-3;  
Category D, 1300-3.  
<sup>2</sup>Categories A, B, 900-2; Category C, 1000-3;  
Category D, 1300-3.

**CLAXTON, GA**

CLAXTON-EVANS  
COUNTY (CWV).....RNAV (GPS) Rwy 10  
RNAV (GPS) Rwy 28

NA when local weather not available.  
Category C, 800-2¼; Category D, 800-2½.

**COCHRAN, GA**

COCHRAN (48A).....RNAV (GPS) Rwy 11  
RNAV (GPS) Rwy 29

NA when local weather not available.

**COLUMBUS, GA**

COLUMBUS (CSG).....ILS or LOC Rwy 6<sup>12</sup>  
RNAV (GPS) Rwy 6<sup>3</sup>  
RNAV (GPS) Rwy 13<sup>3</sup>  
RNAV (GPS) Rwy 24<sup>3</sup>

<sup>1</sup>NA when control tower closed.  
<sup>2</sup>LOC, Category C, 800-2¼; Category D, 1000-3.  
<sup>3</sup>Category C, 800-2¼; Category D, 1000-3.

**CORDELE, GA**

CRISP COUNTY-  
CORDELE (CKF).....RNAV (GPS) Rwy 6  
RNAV (GPS) Rwy 10  
RNAV (GPS) Rwy 24  
RNAV (GPS) Rwy 28

NA when local weather not available.  
Category C, 800-2¼; Category D, 900-2¾.



NAME ALTERNATE MINIMUMS

**CORNELIA, GA**

HABERSHAM  
COUNTY (AJR).....**RNAV (GPS) Rwy 6**  
**RNAV (GPS) Rwy 24**

NA when local weather not available.  
Category B, 900-2; Category C, 900-2½;  
Category D, 900-2¾.

**COURTLAND, AL**

COURTLAND (9A4).....**RNAV (GPS) Rwy 13**  
**RNAV (GPS) Rwy 31**

Category D, 800-2½.  
NA when local weather not available.

**CULLMAN, AL**

CULLMAN RGNL/FOLSOM  
FLD (CMD).....**RNAV (GPS) Rwy 2**  
**RNAV (GPS) Rwy 20**

NA when local weather not available.  
Category D, 800-2¼.

**DALTON, GA**

DALTON MUNI (DNN).....**ILS or LOC Rwy 14**<sup>123</sup>  
**RNAV (GPS) Rwy 14**<sup>4</sup>  
**RNAV (GPS) Rwy 32**<sup>4</sup>

<sup>1</sup>NA when local weather not available.  
<sup>2</sup>NA when CHA APP CON closed.  
<sup>3</sup>LOC, Category D, 800-2¼.  
<sup>4</sup>Category D, 800-2¼.

**DECATUR, AL**

PRYOR FLD  
RGNL (DCU).....**ILS or LOC Rwy 18**<sup>12</sup>  
**RNAV (GPS) Rwy 18**<sup>13</sup>  
**RNAV (GPS) Rwy 36**<sup>3</sup>

<sup>1</sup>NA when local weather not available.  
<sup>2</sup>LOC, Category C, 800-2¼; Category D, 800-2½.  
<sup>3</sup>Category C, 800-2¼; Category D, 800-2½.

**DEMOPOLIS, AL**

DEMOPOLIS  
RGNL (DYA).....**RNAV (GPS) Rwy 4**  
NA when local weather not available.

**DONALSONVILLE, GA**

DONALSONVILLE  
MUNI (17J).....**RNAV (GPS) Rwy 1**  
**RNAV (GPS) Rwy 19**

NA when local weather not available.  
Category D, 800-2¼.

NAME ALTERNATE MINIMUMS

**DOTHAN, AL**

DOTHAN RGNL (DHN).....**COPTER VOR Rwy 36**<sup>1</sup>  
**ILS or LOC Rwy 14**<sup>23</sup>  
**ILS or LOC Rwy 32**<sup>24</sup>  
**VOR or TACAN Rwy 14**<sup>5</sup>  
**VOR or TACAN-A**<sup>5</sup>

<sup>1</sup>NA when local weather not available.  
<sup>2</sup>NA when control tower closed.  
<sup>3</sup>LOC, Category D, 800-2¼; Category E, 800-2½.  
<sup>4</sup>LOC, Categories A, B, 900-2;  
Category C, 900-2½; Category D, 900-2¾;  
Category E, 900-3.  
<sup>5</sup>Category E, 800-2¼.

**DOUGLAS, GA**

DOUGLAS  
MUNI (DQH).....**ILS or LOC Rwy 4**<sup>1</sup>  
**RNAV (GPS) Rwy 22**<sup>2</sup>

<sup>1</sup>ILS, Category D, 1000-3.  
<sup>2</sup>Category D, 1000-3.

**DUBLIN, GA**

W H 'BUD'  
BARRON (DBN).....**ILS or LOC Rwy 2**  
**RNAV (GPS) Rwy 2**<sup>1</sup>  
**RNAV (GPS) Rwy 20**<sup>1</sup>

NA when local weather not available.  
<sup>1</sup>Category D, 800-2¼.

**EASTMAN, GA**

HEART OF GEORGIA  
RGNL (EZM).....**ILS or LOC Rwy 2**<sup>1</sup>  
**RNAV (GPS) Rwy 2**  
**RNAV (GPS) Rwy 20**

NA when local weather not available.  
<sup>1</sup>NA when control tower closed.

**ELBERTON, GA**

ELBERT COUNTY-  
PATZ FLD (EBA).....**RNAV (GPS) Rwy 11**  
**RNAV (GPS) Rwy 29**  
**VOR Rwy 11**

NA when local weather not available.

**ELLIJAY, GA**

GILMER  
COUNTY (49A).....**RNAV (GPS) Rwy 3**  
**RNAV (GPS) Rwy 21**

Category B, 1100-2; Categories C, D, 1100-3.

**EVERGREEN, AL**

EVERGREEN RGNL/MIDDLETON  
FLD (GZH).....**RNAV (GPS) Rwy 1**  
**RNAV (GPS) Rwy 10**  
**RNAV (GPS) Rwy 19**  
**RNAV (GPS) Rwy 28**  
**VOR/DME Rwy 10**

NA when local weather not available.  
Category D, 900-2¼.

22 FEB 2024 to 21 MAR 2024

22 FEB 2024 to 21 MAR 2024

NAME ALTERNATE MINIMUMS

**FAIRHOPE, AL**

H L SONNY  
CALLAHAN (CQF).....RNAV (GPS) Rwy 1  
RNAV (GPS) Rwy 19  
VOR/DME-A

NA when local weather not available.

**FITZGERALD, GA**

FITZGERALD  
MUNI (FZG).....LOC Rwy 2  
NDB Rwy 2  
RNAV (GPS) Rwy 2

NA when local weather not available.  
Category C, 800-2¼; Category D, 800-2½.

**FLORALA, AL**

FLORALA MUNI (0J4).....RNAV (GPS) Rwy 22  
NA when local weather not available.

**FORT PAYNE, AL**

ISELL FLD (4A9).....RNAV (GPS) Rwy 4<sup>12</sup>  
RNAV (GPS) Y Rwy 22<sup>3</sup>  
RNAV (GPS) Z Rwy 22<sup>1</sup>

<sup>1</sup>NA when local weather not available.  
<sup>2</sup>Category B, 1100-2; Category C, 1100-3.  
<sup>3</sup>Category A, 900-2; Category B, 1100-2;  
Categories C, D, 1100-3.

**FORT STEWART (HINESVILLE), GA**

WRIGHT AAF (FORT STEWART)  
MIDCOAST RGNL (LHW).....NDB Rwy 33R  
RNAV (GPS) Rwy 33R

NA when local weather not available.

**GADSDEN, AL**

NORTHEAST ALABAMA  
RGNL (GAD).....ILS or LOC Rwy 24<sup>1</sup>  
RNAV (GPS) Rwy 6<sup>2</sup>  
RNAV (GPS) Rwy 18<sup>3</sup>  
RNAV (GPS) Rwy 24  
RNAV (GPS) Rwy 36<sup>4</sup>  
VOR Rwy 6<sup>2</sup>

NA when local weather not available.  
<sup>1</sup>LOC, Category C, 900-2¼; Category D, 1200-3.  
<sup>2</sup>Category C, 900-2¼; Category D, 1200-3.  
<sup>3</sup>Categories A, B, C, 1100-4; Category D, 1200-4.  
<sup>4</sup>Categories A, B, 1100-2; Category C, 1100-3;  
Category D, 1200-3.

**GAINESVILLE, GA**

LEE GILMER  
MEML (GVL).....ILS or LOC Rwy 5<sup>1</sup>  
RNAV (GPS) Rwy 5<sup>2</sup>  
RNAV (GPS) Rwy 23<sup>2</sup>

NA when local weather not available.  
<sup>1</sup>LOC, Category D, 800-2½.  
<sup>2</sup>Category D, 800-2½.

NAME ALTERNATE MINIMUMS

**GREENSBORO, GA**

GREENE COUNTY  
RGNL (CPP).....RNAV (GPS) Rwy 7  
RNAV (GPS) Rwy 25<sup>1</sup>  
VOR-B<sup>1</sup>

NA when local weather not available.  
<sup>1</sup>Category D, 800-2½.

**GULF SHORES, AL**

GULF SHORES INTL/JACK EDWARDS  
FLD (JKA).....ILS or LOC Rwy 27<sup>1</sup>  
RNAV (GPS) Rwy 9<sup>2</sup>  
RNAV (GPS) Rwy 27<sup>2</sup>

NA when local weather not available.  
<sup>1</sup>ILS, Category C, 800-2; Category D, 800-2¼;  
LOC, Category D, 800-2¼.  
<sup>2</sup>Category D, 800-2¼.

**HALEYVILLE, AL**

POSEY FLD (1M4).....RNAV (GPS) Rwy 18  
RNAV (GPS) Rwy 36

NA when local weather not available.

**HAZLEHURST, GA**

HAZLEHURST (AZE).....RNAV (GPS) Rwy 15<sup>1</sup>  
RNAV (GPS) Rwy 33<sup>2</sup>

NA when local weather not available.  
<sup>1</sup>Category D, 800-2½.  
<sup>2</sup>Category D, 800-2¼.

**HEADLAND, AL**

HEADLAND MUNI (HDL).....RNAV (GPS) Rwy 9  
RNAV (GPS) Rwy 27

NA when local weather not available.

**HOMERVILLE, GA**

HOMERVILLE (HOE).....NDB Rwy 14  
RNAV (GPS) Rwy 14  
RNAV (GPS) Rwy 32  
VOR/DME-A

NA when local weather not available.  
Category C, 800-2¼; Category D, 800-2½.

**HUNTSVILLE, AL**

HUNTSVILLE INTL-CARL T JONES  
FLD (HSV).....ILS or LOC Rwy 18L<sup>12</sup>  
ILS or LOC Rwy 18R<sup>12</sup>  
ILS or LOC Rwy 36L<sup>12</sup>  
ILS or LOC Rwy 36R<sup>12</sup>  
RADAR-1<sup>34</sup>  
RNAV (GPS) Rwy 18L<sup>15</sup>  
RNAV (GPS) Rwy 18R<sup>15</sup>  
RNAV (GPS) Rwy 36L<sup>15</sup>  
RNAV (GPS) Rwy 36R<sup>15</sup>

<sup>1</sup>NA when local weather not available.  
<sup>2</sup>LOC, Category E, 800-2¼.  
<sup>3</sup>NA when control tower closed.  
<sup>4</sup>Category D, 800-2¼; Category E, 800-2½.  
<sup>5</sup>Category E, 800-2¼.

22 FEB 2024 to 21 MAR 2024

22 FEB 2024 to 21 MAR 2024

NAME ALTERNATE MINIMUMS

**HUNTSVILLE, AL (CON'T)**  
HUNTSVILLE EXEC TOM SHARP JR  
FLD (MDQ).....**ILS or LOC Rwy 18<sup>1</sup>**  
**RNAV (GPS) Rwy 18<sup>2</sup>**  
**RNAV (GPS) Rwy 36<sup>2</sup>**  
**VOR-B<sup>2</sup>**

<sup>1</sup>LOC, Category C, 800-2¼; Category D, 1300-3.  
<sup>2</sup>Category C, 800-2¼; Category D, 1300-3.

**JASPER, AL**  
WALKER COUNTY/  
BEVILL FLD (JFX).....**RNAV (GPS) Rwy 9**  
**RNAV (GPS) Rwy 27**  
**VOR/DME-A**

NA when local weather not available.  
Category D, 900-2¾.

**JASPER, GA**  
PICKENS  
COUNTY (JZP).....**RNAV (GPS) Rwy 16<sup>1</sup>**  
**RNAV (GPS) Rwy 34<sup>2</sup>**

NA when local weather not available.  
<sup>1</sup>Category B, 900-2; Categories C, D, 1300-3.  
<sup>2</sup>Category B, 900-2; Categories C, 1300-3.

**JEFFERSON, GA**  
JACKSON  
COUNTY (JCA).....**RNAV (GPS) Rwy 17**  
**RNAV (GPS) Rwy 35**

NA when local weather not available.

**JESUP, GA**  
JESUP-WAYNE  
COUNTY (JES).....**RNAV (GPS) Rwy 29**  
Category D, 800-2¼.

**LAFAYETTE, GA**  
BARWICK  
LAFAYETTE (9A5).....**RNAV (GPS) Rwy 2**  
**RNAV (GPS) Rwy 20**

NA when local weather not available.  
Category A, 900-2.

**LAGRANGE, GA**  
LAGRANGE/  
CALLAWAY (LGC).....**RNAV (GPS) Rwy 3**  
**RNAV (GPS) Rwy 13**  
**RNAV (GPS) Rwy 31<sup>1</sup>**

Category C, 900-2½; Category D, 1000-3.  
<sup>1</sup>NA when local weather not available.

**LAWRENCEVILLE, GA**  
GWINNETT COUNTY/  
BRISCOE FLD (LZU).....**ILS or LOC Rwy 25**  
**RNAV (GPS) Rwy 7**  
**RNAV (GPS) Rwy 25**

NA when local weather not available.

NAME ALTERNATE MINIMUMS

**LOUISVILLE, GA**  
LOUISVILLE MUNI (2J3).....**RNAV (GPS) Rwy 31**  
NA when local weather not available.

**MACON, GA**  
MIDDLE GEORGIA  
RGNL (MCN).....**ILS or LOC Rwy 5<sup>12</sup>**  
**RNAV (GPS) Rwy 5<sup>3</sup>**  
**RNAV (GPS) Rwy 14<sup>3</sup>**  
**RNAV (GPS) Rwy 23<sup>3</sup>**  
**RNAV (GPS) Rwy 32<sup>3</sup>**

<sup>1</sup>NA when control tower closed.  
<sup>2</sup>LOC, Category, D, 800-2¼; Category E, 900-3.  
<sup>3</sup>Category D, 800-2½.

**MC RAE, GA**  
TELFAIR-  
WHEELER (MQW).....**RNAV (GPS) Rwy 3<sup>1</sup>**  
**RNAV (GPS) Rwy 21<sup>2</sup>**

NA when local weather not available.  
<sup>1</sup>Categories A, B, 1000-2; Categories C, D, 1000-3.  
<sup>2</sup>Category C, 800-2¼; Category D, 1000-3.

**MILLEDGEVILLE, GA**  
BALDWIN COUNTY  
RGNL (MLJ).....**NDB Rwy 28**  
**RNAV (GPS) Rwy 10**  
**RNAV (GPS) Rwy 28**

NA when local weather not available.  
Category D, 900-3.

**MILLEN, GA**  
MILLEN (2J5).....**RNAV (GPS) Rwy 17**  
**RNAV (GPS) Rwy 35**

Category D, 800-2½.

**MOBILE, AL**  
MOBILE INTL (BFM).....**ILS or LOC Rwy 32<sup>123</sup>**  
**RNAV (GPS) Rwy 14<sup>14</sup>**  
**RNAV (GPS) Rwy 18<sup>14</sup>**  
**RNAV (GPS) Rwy 32<sup>14</sup>**  
**RNAV (GPS) Rwy 36<sup>14</sup>**  
**VOR Rwy 14<sup>14</sup>**  
**VOR Rwy 18<sup>4</sup>**  
**VOR Rwy 32<sup>1</sup>**

<sup>1</sup>NA when local weather not available.  
<sup>2</sup>NA when control tower closed.  
<sup>3</sup>LOC, Category D, 1100-3.  
<sup>4</sup>Category D, 1100-3.

MOBILE RGNL (MOB).....**ILS or LOC Rwy 15**  
**ILS or LOC Rwy 33**

NA when control tower closed.

**MONROE, GA**  
CY NUNNALLY  
MEML (D73).....**RNAV (GPS) Rwy 3**  
NA when local weather not available.

22 FEB 2024 to 21 MAR 2024

22 FEB 2024 to 21 MAR 2024

NAME ALTERNATE MINIMUMS

**MONTGOMERY, AL**

MONTGOMERY RGNL (DANNELY FLD)  
(MGM).....**ILS Y or LOC Rwy 28<sup>12</sup>**  
**ILS Z or LOC Z Rwy 10<sup>3</sup>**  
**RNAV (GPS) Rwy 10<sup>4</sup>**  
**RNAV (GPS) Rwy 28<sup>4</sup>**

<sup>1</sup>LOC, Category E, 800-2¼.  
<sup>2</sup>NA when control tower closed.  
<sup>3</sup>ILS, NA when control tower closed; LOC, NA.  
<sup>4</sup>Category E, 800-2¼.

**MOULTRIE, GA**

MOULTRIE MUNI (MGR).....**RNAV (GPS) Rwy 4**  
**RNAV (GPS) Rwy 22**

NA when local weather not available.  
Category D, 800-2¼.

**MUSCLE SHOALS, AL**

NORTHWEST ALABAMA  
RGNL (MSL).....**ILS Y or LOC Y Rwy 30<sup>1</sup>**  
**ILS Z or LOC Z Rwy 30<sup>1</sup>**  
**RNAV (GPS) Rwy 12<sup>2</sup>**  
**RNAV (GPS) Rwy 18**  
**RNAV (GPS) Rwy 30<sup>2</sup>**  
**RNAV (GPS) Rwy 36<sup>2</sup>**

NA when local weather not available.  
<sup>1</sup>LOC, Category D, 800-2¼.  
<sup>2</sup>Category D, 800-2¼.

**PRATTVILLE, AL**

PRATTVILLE/GROUBY  
FLD (1A9).....**RNAV (GPS) Rwy 27**  
Category C, 900-2½; Category D, 1000-3.

**PELL CITY, AL**

ST CLAIR  
COUNTY (PLR).....**RNAV (GPS) Rwy 3**  
**RNAV (GPS) Rwy 21**

NA when local weather not available.  
Category C, 800-2¼; Category D, 900-2¼.

**PERRY, GA**

PERRY-HOUSTON  
COUNTY (PX).....**ILS or LOC Rwy 36<sup>1</sup>**  
**RNAV (GPS) Rwy 18<sup>2</sup>**  
**RNAV (GPS) Rwy 36<sup>3</sup>**

NA when local weather not available.  
<sup>1</sup>LOC, Category D, 900-2¾.  
<sup>2</sup>Category C, 800-2½; Category D, 900-2¾.  
<sup>3</sup>Category D, 900-2¾.

**PINE MOUNTAIN, GA**

HARRIS  
COUNTY (PIM).....**RNAV (GPS) Rwy 9**  
NA when local weather not available.  
Category C, 800-2¼; Category D, 1000-3.

NAME ALTERNATE MINIMUMS

**REIDSVILLE, GA**

SWINTON SMITH FLD AT REIDSVILLE  
MUNI (RVJ).....**RNAV (GPS) Rwy 11**  
NA when local weather not available.

**ROME, GA**

RICHARD B RUSSELL RGNL – J H TOWERS  
FLD (RMG).....**ILS or LOC Rwy 1<sup>1</sup>**  
**RNAV (GPS) Rwy 1<sup>2</sup>**  
**RNAV (GPS) Rwy 7<sup>2</sup>**  
**RNAV (GPS) Rwy 19<sup>2</sup>**  
**RNAV (GPS) Rwy 25<sup>2</sup>**

NA when local weather not available.  
<sup>1</sup>LOC, Category C, 900-2½; Category D, 1200-3.  
<sup>2</sup>Category C, 900-2½; Category D, 1200-3.

**SANDERSVILLE, GA**

KAOLIN FLD (OKZ).....**RNAV (GPS) Rwy 13**  
**RNAV (GPS) Rwy 31**  
NA when local weather not available.  
Category C, 900-2¼.

**SAVANNAH, GA**

SAVANNAH/HILTON  
HEAD INTL (SAV).....**ILS or LOC Rwy 1<sup>12</sup>**  
**ILS or LOC Rwy 10<sup>12</sup>**  
**RNAV (GPS) Rwy 1<sup>34</sup>**  
**RNAV (GPS) Rwy 10<sup>3</sup>**  
**RNAV (GPS) Rwy 19<sup>34</sup>**  
**RNAV (GPS) Z Rwy 28<sup>34</sup>**  
**VOR/DME-A<sup>35</sup>**  
**VOR/DME or TACAN Rwy 1<sup>35</sup>**  
**VOR/DME or TACAN Rwy 19<sup>35</sup>**

<sup>1</sup>NA when control tower closed.  
<sup>2</sup>LOC, Category D, 800-2¼.  
<sup>3</sup>NA when local weather not available.  
<sup>4</sup>Category D, 800-2¼.  
<sup>5</sup>Category D, 800-2¼; Category E, 900-3.

**SCOTTSBORO, AL**

SCOTTSBORO MUNI-  
WORD FLD (4A6).....**RNAV (GPS) Rwy 4**  
**RNAV (GPS) Rwy 22**  
Category A, 1000-2; Category B, 1100-2;  
Categories C, D, 1200-3.

**SELMA, AL**

CRAIG FLD (SEM).....**RNAV (GPS) Rwy 15**  
**RNAV (GPS) Rwy 33**  
NA when local weather not available.  
Category D, 900-2¾.

**STATESBORO, GA**

STATESBORO-BULLOCH  
COUNTY (TBR).....**ILS or LOC Rwy 32<sup>12</sup>**  
**RNAV (GPS) Rwy 14<sup>13</sup>**  
**RNAV (GPS) Rwy 32<sup>3</sup>**

<sup>1</sup>NA when local weather not available.  
<sup>2</sup>LOC, Category D, 800-2¼.  
<sup>3</sup>Category D, 800-2¼.

22 FEB 2024 to 21 MAR 2024

22 FEB 2024 to 21 MAR 2024

## NAME ALTERNATE MINIMUMS

**SWAINSBORO, GA**

EAST GEORGIA  
 RGNL (SBO).....**ILS or LOC Rwy 14<sup>1</sup>**  
**RNAV (GPS) Rwy 14<sup>2</sup>**  
**RNAV (GPS) Rwy 32<sup>2</sup>**

NA when local weather not available.

<sup>1</sup>LOC, Category D, 800-2½.

<sup>2</sup>Category D, 800-2¼.

**SYLACAUGA, AL**

MERKEL FLD SYLACAUGA  
 MUNI (SCD).....**RNAV (GPS) Rwy 9**  
**RNAV (GPS) Rwy 27**

NA when local weather not available.

Category B, 900-2; Category C, 1100-3;

Category D, 1200-3.

**SYLVANIA, GA**

PLANTATION  
 AIRPARK (JYL).....**RNAV (GPS) Rwy 5**  
**RNAV (GPS) Rwy 23**

NA when local weather not available.

Category D, 900-2¼.

**TALLADEGA, AL**

TALLADEGA  
 MUNI (ASN).....**RNAV (GPS) Rwy 4**

NA when local weather not available.

Category C, 900-2½; Category D, 1000-3.

**THOMASTON, GA**

THOMASTON-UPSON  
 COUNTY (OPN).....**ILS or LOC Rwy 30<sup>1</sup>**  
**NDB Rwy 30<sup>2</sup>**  
**RNAV (GPS) Rwy 12<sup>2</sup>**  
**RNAV (GPS) Rwy 30<sup>2</sup>**

NA when local weather not available.

<sup>1</sup>LOC Category D, 900-3.

<sup>2</sup>Category D, 900-3.

**THOMSON, GA**

THOMSON-MCDUFFIE  
 COUNTY (HQU).....**RNAV (GPS) Rwy 10**  
**RNAV (GPS) Rwy 28<sup>1</sup>**  
**VOR/DME-A<sup>1</sup>**

NA when local weather not available.

<sup>1</sup>Category D, 800-2¼.

**THOMASVILLE, GA**

THOMASVILLE  
 RGNL (TVI).....**ILS or LOC Rwy 22<sup>1</sup>**  
**NDB Rwy 22<sup>2</sup>**  
**RNAV (GPS) Rwy 4<sup>2</sup>**  
**RNAV (GPS) Rwy 22<sup>2</sup>**

NA when local weather not available.

<sup>1</sup>ILS, Category C, 700-2; Category D, 800-2½;

LOC, Category D, 800-2½.

<sup>2</sup>Category D, 800-2½.

## NAME ALTERNATE MINIMUMS

**TIFTON, GA**

HENRY TIFT  
 MYRES (TMA).....**RNAV (GPS) Rwy 16**  
**RNAV (GPS) Rwy 34**

Category D, 900-3.

**TROY, AL**

TROY MUNI AT N KENNETH  
 CAMPBELL FLD (TOI).....**ILS or LOC Rwy 7<sup>123</sup>**  
**NDB Rwy 7<sup>124</sup>**  
**RADAR-1<sup>4</sup>**  
**RNAV (GPS) Rwy 7<sup>24</sup>**  
**RNAV (GPS) Rwy 14<sup>24</sup>**  
**RNAV (GPS) Rwy 25<sup>24</sup>**  
**RNAV (GPS) Rwy 32<sup>24</sup>**

<sup>1</sup>NA when tower closed.

<sup>2</sup>NA when local weather not available.

<sup>3</sup>ILS, Categories A, B, 700-2;

Category C, 1000-2¾; Category D, 1000-3;

LOC, Category C, 1000-2¾, Category D, 1000-3.

<sup>4</sup>Category C, 1000-2¾; Category D, 1000-3.

**TUSCALOOSA, AL**

TUSCALOOSA  
 NTL (TCL).....**ILS or LOC Rwy 4<sup>12</sup>**  
**RNAV (GPS) Rwy 4<sup>3</sup>**  
**RNAV (GPS) Rwy 12<sup>3</sup>**  
**RNAV (GPS) Rwy 22<sup>3</sup>**  
**RNAV (GPS) Rwy 30<sup>3</sup>**  
**TACAN Rwy 4<sup>3</sup>**  
**TACAN Rwy 22<sup>3</sup>**

NA when local weather not available.

<sup>1</sup>NA when control tower closed.

<sup>2</sup>LOC, Category C, 800-2¼; Category D 800-2½.

<sup>3</sup>Category C, 800-2¼; Category D 800-2½.

**VALDOSTA, GA**

VALDOSTA  
 RGNL (VLD).....**ILS or LOC Rwy 36<sup>12</sup>**  
**RNAV (GPS) Rwy 4<sup>3</sup>**  
**RNAV (GPS) Rwy 18<sup>3</sup>**  
**RNAV (GPS) Rwy 36<sup>3</sup>**  
**VOR Rwy 18<sup>3</sup>**  
**VOR Rwy 36<sup>3</sup>**

NA when local weather not available.

<sup>1</sup>NA when control tower closed.

<sup>2</sup>LOC, Category D, 900-2¾; Category E, 900-3.

<sup>3</sup>Category D, 900-2¾.

**VIDALIA, GA**

VIDALIA RGNL (VDI).....**RNAV (GPS) Rwy 7**  
**RNAV (GPS) Rwy 25<sup>1</sup>**

Category D, 800-2¼.

<sup>1</sup>NA when local weather not available.

**WASHINGTON, GA**

WASHINGTON/WILKES  
 COUNTY (IHY).....**RNAV (GPS) Rwy 13**  
**RNAV (GPS) Rwy 31**

NA when local weather not available.

24025

NAME ALTERNATE MINIMUMS NAME ALTERNATE MINIMUMS

**WAYCROSS, GA**

WAYCROSS-WARE

COUNTY (AYS).....**ILS Y or LOC Y Rwy 19<sup>1</sup>**  
**ILS Z or LOC Z Rwy 19<sup>1</sup>**  
**RNAV (GPS) Rwy 1<sup>2</sup>**  
**RNAV (GPS) Rwy 19<sup>2</sup>**  
**VOR-A<sup>2</sup>**

NA when local weather not available.

<sup>1</sup>ILS, Category C, 800-2; Category D, 800-2½.

<sup>1</sup>LOC, Category D, 800-2½.

<sup>2</sup>Category D, 800-2½.

**WINDER, GA**

BARROW COUNTY (WDR)....**ILS or LOC Rwy 31<sup>1</sup>**  
**NDB Rwy 31<sup>2</sup>**  
**RNAV (GPS) Rwy 13<sup>2</sup>**  
**RNAV (GPS) Rwy 23<sup>2</sup>**  
**RNAV (GPS) Rwy 31<sup>2</sup>**

NA when local weather not available.

<sup>1</sup>LOC, Category D, 800-2½.

<sup>2</sup>Category D, 800-2½.

22 FEB 2024 to 21 MAR 2024

22 FEB 2024 to 21 MAR 2024

24025

M9

# TAKEOFF MINIMUMS, (OBSTACLE) DEPARTURE PROCEDURES, AND DIVERSE VECTOR AREA (RADAR VECTORS)

24025

INSTRUMENT APPROACH PROCEDURE CHARTS

## IFR TAKEOFF MINIMUMS AND (OBSTACLE) DEPARTURE PROCEDURES

Civil Airports and Selected Military Airports

ALL USERS: Airports that have Departure Procedures (DPs) designed specifically to assist pilots in avoiding obstacles during the climb to the minimum enroute altitude, and/or airports that have civil IFR takeoff minimums other than standard, are listed below. Takeoff Minimums and Departure Procedures apply to all runways unless otherwise specified. An entry may also be listed that contains only Takeoff Obstacle Notes. Altitudes, unless otherwise indicated, are minimum altitudes in MSL.

DPs specifically designed for obstacle avoidance are referred to as Obstacle Departure Procedures (ODPs) and are textually described below, or published separately as a graphic procedure. If the ODP is published as a graphic procedure, its name will be listed below, and it can be found in either this volume (civil), or the applicable military volume, as appropriate. Users will recognize graphic obstacle DPs by the term "(OBSTACLE)" included in the procedure title; e.g., TETON TWO (OBSTACLE). If not specifically assigned an ODP, SID, or RADAR vector as part of an IFR clearance, an ODP may be required to be flown for obstacle clearance, even though not specifically stated in the IFR clearance. When doing so in this manner, ATC should be informed when the ODP being used contains a specified route to be flown, restrictions before turning, and/or altitude restrictions.

Some ODPs, which are established solely for obstacle avoidance, require a climb in visual conditions to cross the airport, a fix, or a NAVAID in a specified direction, at or above a specified altitude. These procedures are called Visual Climb Over Airport (VCOA). To ensure safe and efficient operations, the pilot must verbally request approval from ATC to fly the VCOA when requesting their IFR clearance.

At some locations where an ODP has been established, a diverse vector area (DVA) may be created to allow RADAR vectors to be used in lieu of an ODP. DVA information will state that headings will be as assigned by ATC and climb gradients, when applicable, will be published immediately following the specified departure procedure.

Graphic DPs designed by ATC to standardize traffic flows, ensure aircraft separation and enhance capacity are referred to as "Standard Instrument Departures (SIDs)". SIDs also provide obstacle clearance and are published under the appropriate airport section. ATC clearance must be received prior to flying a SID.

CIVIL USERS NOTE: Title 14 Code of Federal Regulations Part 91 prescribes standard takeoff rules and establishes takeoff minimums for certain operators as follows: (1) For aircraft, other than helicopters, having two engines or less – one statute mile visibility. (2) For aircraft having more than two engines – one-half statute mile visibility. (3) For helicopters – one-half statute mile visibility. These standard minima apply in the absence of any different minima listed below.

MILITARY USERS NOTE: Civil (nonstandard) takeoff minima are published below. For military takeoff minima, refer to appropriate service directives.

### ADEL, GA

#### COOK COUNTY (15J)

##### TAKEOFF MINIMUMS AND (OBSTACLE) DEPARTURE PROCEDURES

AMDT 2 10AUG23 (23222) (FAA)

##### DEPARTURE PROCEDURE:

**Rwy 5**, climb on heading 051° to 1500 before right turn.

##### TAKEOFF OBSTACLE NOTES:

**Rwy 5**, trees, vegetation beginning 65' from DER, 28' left of centerline, up to 249' MSL.  
 Vehicle on roadway, trees beginning 103' from DER, 60' right of centerline, up to 251' MSL.  
 Trees beginning 284' from DER, 4' right of centerline, up to 259' MSL.  
 Vehicle on roadway beginning 374' from DER, on and left of centerline, up to 251' MSL.  
 Tree, vehicle on roadway beginning 404' from DER, 113' right of centerline, up to 273' MSL.  
 Trees beginning 524' from DER, 445' left of centerline, up to 270' MSL.  
 Trees beginning 697' from DER, 636' right of centerline, up to 276' MSL.  
 Trees beginning 969' from DER, 619' left of centerline, up to 285' MSL.  
 Trees beginning 1161' from DER, 53' left of centerline, up to 316' MSL.  
 Trees beginning 1184' from DER, 533' right of centerline, up to 299' MSL.  
 Trees beginning 2524' from DER, 359' left of centerline, up to 322' MSL.  
 Trees beginning 2647' from DER, 460' left of centerline, up to 324' MSL.  
 Trees beginning 2934' from DER, 386' right of centerline, up to 319' MSL.  
 Tree 3116' from DER, 637' right of centerline, 322' MSL.  
 Tree 3176' from DER, 232' right of centerline, 323' MSL.  
 Trees beginning 3220' from DER, 78' right of centerline, up to 329' MSL.  
 Trees beginning 3280' from DER, 10' left of centerline, up to 332' MSL.  
 Trees beginning 3359' from DER, 57' right of centerline, up to 331' MSL.  
**Rwy 15**, trees beginning 100' from DER, 283' right of centerline, up to 302' MSL.  
 Tree 364' from DER, 430' right of centerline, 309' MSL.  
 Trees beginning 453' from DER, 344' right of centerline, up to 313' MSL.  
 Tree 570' from DER, 485' left of centerline, 297' MSL.  
 Trees beginning 573' from DER, 471' right of centerline, up to 315' MSL.

**CON'T**

22 FEB 2024 to 21 MAR 2024

22 FEB 2024 to 21 MAR 2024

# TAKEOFF MINIMUMS, (OBSTACLE) DEPARTURE PROCEDURES, AND DIVERSE VECTOR AREA (RADAR VECTORS)

24025

SE-4

# TAKEOFF MINIMUMS, (OBSTACLE) DEPARTURE PROCEDURES, AND DIVERSE VECTOR AREA (RADAR VECTORS)

24025

## ADEL, GA (CON'T)

### COOK COUNTY (15J) (CON'T)

**Rwy 23**, terrain 17' from DER, 481' right of centerline, 236' MSL.  
 Tree 24' from DER, 343' left of centerline, 255' MSL.  
 Trees beginning 83' from DER, 256' left of centerline, up to 260' MSL.  
 Trees beginning 157' from DER, 46' left of centerline, up to 261' MSL.  
 Tree 197' from DER, 484' right of centerline, 274' MSL.  
 Trees beginning 219' from DER, 200' right of centerline, up to 284' MSL.  
 Trees beginning 892' from DER, 118' right of centerline, up to 305' MSL.  
 Trees beginning 1421' from DER, 520' left of centerline, up to 291' MSL.

## ALABASTER, AL

### SHELBY COUNTY (EET)

#### TAKEOFF MINIMUMS AND (OBSTACLE) DEPARTURE PROCEDURES

AMDT 3 12MAR09 (09071) (FAA)

##### TAKEOFF MINIMUMS:

**Rwy 16**, 300-1¼.

**Rwy 34**, 300-1 w/ min. climb of 310' per NM to 1500, or 1000-2½ for climb in visual conditions.

##### DEPARTURE PROCEDURE:

**Rwy 34**, for climb in visual conditions: Cross Shelby County Airport at or above 1400 MSL before proceeding on course.

##### TAKEOFF OBSTACLE NOTES:

**Rwy 16**, rising terrain beginning 30' from DER.

Trees beginning 4' from DER, 648' left to 826' right of centerline, up to 100' AGL/759' MSL.

T-L towers beginning 1165' from DER, 490' left of centerline, up to 98' AGL/704' MSL.

Buildings 1569' from DER, 89' left of centerline, up to 38' AGL/657' MSL.

**Rwy 34**, rising terrain beginning 132' from DER.

Trees beginning 240' from DER, 1498' left to 3865' right of centerline, up to 100' AGL/799' MSL.

T-L towers beginning 1821' from DER, 646' right of centerline, up to 89' AGL/715' MSL.

Buildings beginning 1562' from DER, 87' left of centerline up to 31' AGL/661' MSL.

Buildings beginning 1863' from DER, 135' right of centerline, up to 45' AGL/668' MSL.

Tower 2.08 NM from DER, 513' left of centerline, 220' AGL/919' MSL.

## ALBANY, GA

### SOUTHWEST GEORGIA RGNL (ABY)

#### TAKEOFF MINIMUMS AND (OBSTACLE) DEPARTURE PROCEDURES

ORIG-B 26MAR20 (20086) (FAA)

##### TAKEOFF MINIMUMS:

**Rwy 35**, 300-2 or std. w/min. climb of 255' per NM to 600.

##### DEPARTURE PROCEDURE:

**Rwy 5**, climb heading 047° to 700 before turning left.

**Rwy 35**, climb heading 347° to 700 before turning right.

##### TAKEOFF OBSTACLE NOTES:

**Rwy 5**, trees and tank beginning 913' from DER, 383' left of centerline, up to 127' AGL/329' MSL.

Trees beginning 1985' from DER, 797' right of centerline, up to 79' AGL/275' MSL.

**Rwy 17**, trees beginning 1044' from DER, 310' left of centerline, up to 59' AGL/253' MSL.

Trees beginning 1977' from DER, 81' right of centerline, up to 92' AGL/286' MSL.

**Rwy 23**, tree 1461' from DER, 793' left of centerline, 81' AGL/250' MSL.

Pole 1093' from DER, 731' left of centerline, 61' AGL/230' MSL.

**Rwy 35**, trees beginning 426' from DER, 14' left of centerline, up to 82' AGL/277' MSL.

Trees beginning 477' from DER, 14' right of centerline, up to 58' AGL/253' MSL.

## ALBERTVILLE, AL

### ALBERTVILLE RGNL/THOMAS J BRUMLIK FLD (8A0)

#### TAKEOFF MINIMUMS AND (OBSTACLE) DEPARTURE PROCEDURES

ORIG 30AUG07 (21336) (FAA)

##### TAKEOFF OBSTACLE NOTES:

**Rwy 5**, trees beginning 18' from DER, 353' left of centerline, up to 56' AGL/1088' MSL.

Trees beginning 724' from DER, 676' right of centerline, up to 60' AGL/1092' MSL.

Poles beginning 12' from DER, 428' left of centerline, up to 24' AGL/1056' MSL.

Terrain beginning 30' from DER, 108' left of centerline, 0' AGL/1047' MSL.

Terrain 30' from DER, 58' right of centerline, 0' AGL/1050' MSL.

**Rwy 23**, trees beginning 47' from DER, 469' right of centerline, up to 14' AGL/1017' MS'-L.

Terrain 36' from DER, 346' right of centerline, 0' AGL/1004' MSL.

# TAKEOFF MINIMUMS, (OBSTACLE) DEPARTURE PROCEDURES, AND DIVERSE VECTOR AREA (RADAR VECTORS)

24025

SE-4



# TAKEOFF MINIMUMS, (OBSTACLE) DEPARTURE PROCEDURES, AND DIVERSE VECTOR AREA (RADAR VECTORS)

24025

## ALEXANDER CITY, AL

THOMAS C RUSSELL FLD (ALX)

TAKEOFF MINIMUMS AND (OBSTACLE) DEPARTURE PROCEDURES

AMDT 3 26JUN14 (21224) (FAA)

TAKEOFF MINIMUMS:

**Rwy 36**, 300-1 or std. w/min. climb of 385' per NM to 1000.

DEPARTURE PROCEDURE:

**Rwy 36**, climb heading 002° to 1300 before turning right.

TAKEOFF OBSTACLE NOTES:

**Rwy 18**, rising terrain beginning 6' from DER, 196' right of centerline, up to 613' MSL.

Trees and fence beginning 131' from DER, 345' right of centerline, up to 100' AGL/704' MSL.

Trees beginning 3233' from DER, 536' right of centerline, up to 100' AGL/693' MSL.

Trees beginning 3772' from DER, 1093' left of centerline, up to 100' AGL/723' MSL.

**Rwy 36**, poles beginning 165' from DER, 4' right and 109' left of centerline, up to 45' AGL/711' MSL.

Rising terrain beginning 94' from DER, 265' right of centerline, up to 708' MSL.

Trees and buildings beginning 15' from DER, 443' left of centerline, up to 100' AGL/709' MSL.

Trees beginning 324' from DER, 74' right of centerline, up to 100' AGL/741' MSL.

Trees, poles and buildings beginning 630' from DER, 3' left of centerline, up to 100' AGL/806' MSL.

Trees, poles and sign beginning 667' from DER, 32' right of centerline, up to 100' AGL/747' MSL.

Poles, trees, buildings and tank beginning 2336' from DER, 113' left of centerline, up to 137' AGL/860' MSL.

Poles beginning 3826' from DER, 164' right of centerline, up to 97' AGL/817' MSL.

## ALICEVILLE, AL

GEORGE DOWNER (AIV)

TAKEOFF MINIMUMS AND (OBSTACLE) DEPARTURE PROCEDURES

ORIG 03APR14 (14093) (FAA)

DEPARTURE PROCEDURE:

**Rwy 6**, climb heading 064° to 2000 before turning.

**Rwy 24**, climb heading 244° to 2000 before turning.

TAKEOFF OBSTACLE NOTES:

**Rwy 6**, vehicle on road, trees, buildings and power poles abeam DER, left and right of centerline, up to 100' AGL/279' MSL.

**Rwy 24**, trees, and power poles abeam DER, left and right of centerline, up to 100' AGL/289' MSL.

## ALMA, GA

BACON COUNTY (AMG)

TAKEOFF MINIMUMS AND (OBSTACLE) DEPARTURE PROCEDURES

ORIG-B 05DEC19 (19339) (FAA)

TAKEOFF OBSTACLE NOTES:

**Rwy 16**, trees beginning 10' from DER, 10' right of centerline, up to 256' MSL.

Trees beginning 11' from DER, 247' left of centerline, up to 230' MSL.

Trees beginning 133' from DER, 231' left of centerline, up to 238' MSL.

Trees beginning 293' from DER, 398' left of centerline, up to 256' MSL.

Trees beginning 414' from DER, 79' left of centerline, up to 257' MSL.

Trees beginning 2441' from DER, 303' left of centerline, up to 265' MSL.

Trees beginning 2523' from DER, 264' left of centerline, up to 267' MSL.

**Rwy 34**, pole 38' from DER, 479' right of centerline, 224' MSL.

Tree, building, pole, sign beginning 127' from DER, 310' left of centerline, up to 261' MSL.

Poles beginning 249' from DER, 478' right of centerline, up to 225' MSL.

Tree, pole beginning 407' from DER, 495' right of centerline, up to 259' MSL.

Tree, pole, tank beginning 501' from DER, 11' right of centerline, up to 280' MSL.

Trees beginning 1299' from DER, 195' left of centerline, up to 268' MSL.

Tree 1364' from DER, 671' left of centerline, 276' MSL.

Trees beginning 1405' from DER, 327' left of centerline, up to 285' MSL.

Tree, pole beginning 1688' from DER, 396' left of centerline, up to 287' MSL.

Tree, pole beginning 1751' from DER, 235' left of centerline, up to 294' MSL.

Tree 2961' from DER, 958' right of centerline, 284' MSL.

Trees beginning 2977' from DER, 1032' right of centerline, up to 288' MSL.

Trees beginning 3044' from DER, 1136' right of centerline, up to 294' MSL.

Trees beginning 3236' from DER, 1136' right of centerline, up to 295' MSL.

22 FEB 2024 to 21 MAR 2024

22 FEB 2024 to 21 MAR 2024

# TAKEOFF MINIMUMS, (OBSTACLE) DEPARTURE PROCEDURES, AND DIVERSE VECTOR AREA (RADAR VECTORS)

24025

SE-4

# TAKEOFF MINIMUMS, (OBSTACLE) DEPARTURE PROCEDURES, AND DIVERSE VECTOR AREA (RADAR VECTORS)

24025

## AMERICUS, GA

JIMMY CARTER RGNL (ACJ)

TAKEOFF MINIMUMS AND (OBSTACLE) DEPARTURE PROCEDURES

AMDT 2A 25JUL13 (13206) (FAA)

TAKEOFF OBSTACLE NOTES:

**Rwy 5**, fence 26' from DER, 471' left of centerline, 13' AGL/464' MSL.

Trees beginning 179' from DER, left and right of centerline, up to 90' AGL/541' MSL.

**Rwy 10**, trees beginning 35' from DER, left and right of centerline, up to 116' AGL/557' MSL.

**Rwy 23**, vehicles on roadway abeam DER, 179' left of centerline, up to 15' AGL/481' MSL.

Trees beginning 65' from DER, left and right of centerline, up to 92' AGL/537' MSL.

Poles beginning 1085' from DER, 310' right of centerline, up to 44' AGL/505' MSL.

**Rwy 28**, vehicles on roadway 479' from DER, 619' right of centerline, up to 15' AGL/484' MSL.

Trees beginning 2275' from DER, 285' left of centerline, up to 100' AGL/569' MSL.

## ANDALUSIA/OPP, AL

SOUTH ALABAMA RGNL AT BILL BENTON FLD (79J)

TAKEOFF MINIMUMS AND (OBSTACLE) DEPARTURE PROCEDURES

AMDT 1 28SEP06 (21140) (FAA)

TAKEOFF OBSTACLE NOTES:

**Rwy 11**, multiple trees beginning 379' from DER, 279' left of centerline, up to 59' AGL/368' MSL.

Multiple trees beginning 1478' from DER, 687' right of centerline, up to 71' AGL/380' MSL.

**Rwy 29**, multiple trees beginning 93' from DER, 490' left of centerline, up to 85' AGL/394' MSL.

Multiple trees beginning 40' from DER, 353' right of centerline, up to 66' AGL/375' MSL.

## ANNISTON, AL

ANNISTON RGNL (ANB)

TAKEOFF MINIMUMS AND (OBSTACLE) DEPARTURE PROCEDURES

AMDT 7 17AUG17 (17229) (FAA)

TAKEOFF MINIMUMS:

**Rwy 5**, std. w/ min. climb of 329' per NM to 2600.

**Rwy 23**, std. w/ min. climb of 223' per NM to 3800.

DEPARTURE PROCEDURE:

**Rwy 5**, climb heading 052° to 2600 before proceeding on course.

**Rwy 23**, climb heading 232° to 2500 before proceeding on course.

TAKEOFF OBSTACLE NOTES:

**Rwy 5**, tree, railroad beginning 0' from DER, 435' left of centerline, up to 679' MSL.

Pole 507' from DER, 548' right of centerline, 20' AGL/636' MSL.

Tree 1147' from DER, 731' left of centerline, 689' MSL.

Tree 1971' from DER, 262' right of centerline, 690' MSL.

Tree 1992' from DER, 850' left of centerline, 706' MSL.

Sign, pole, tree beginning 2269' from DER, 394' left of centerline, up to 63' AGL/712' MSL.

Tree 2413' from DER, 481' right of centerline, 692' MSL.

Tree 2573' from DER, 221' right of centerline, 695' MSL.

Tree 2695' from DER, 518' right of centerline, 698' MSL.

Tree 2974' from DER, 772' left of centerline, 717' MSL.

Tree 3048' from DER, 297' right of centerline, 718' MSL.

**Rwy 23**, tree 4545' from DER, 1237' left of centerline, 717' MSL.

## ASHBURN, GA

TURNER COUNTY (75J)

TAKEOFF MINIMUMS AND (OBSTACLE) DEPARTURE PROCEDURES

ORIG 12OCT17 (17285) (FAA)

TAKEOFF MINIMUMS:

**Rwy 35**, std. w/min. climb of 290' per NM to 700 or 900-2½ for VCOA.

VCOA:

**Rwy 35**, obtain ATC approval for VCOA when requesting IFR clearance. Climb in visual conditions to cross Turner County airport at or above 1100 before proceeding on course.

TAKEOFF OBSTACLE NOTES:

**Rwy 17**, tree 83' from DER, 419' right of centerline, 440' MSL.

Tree 142' from DER, 342' left of centerline, 422' MSL.

Tree 157' from DER, 448' left of centerline, 438' MSL.

Trees beginning 162' from DER, 165' right of centerline, up to 447' MSL.

Trees beginning 262' from DER, 200' left of centerline, up to 440' MSL.

Tree and building beginning 511' from DER, 347' right of centerline, up to 449' MSL.

Trees beginning 754' from DER, 281' right of centerline, up to 455' MSL.

CONT

22 FEB 2024 to 21 MAR 2024

22 FEB 2024 to 21 MAR 2024

# TAKEOFF MINIMUMS, (OBSTACLE) DEPARTURE PROCEDURES, AND DIVERSE VECTOR AREA (RADAR VECTORS)

24025

# TAKEOFF MINIMUMS, (OBSTACLE) DEPARTURE PROCEDURES, AND DIVERSE VECTOR AREA (RADAR VECTORS)

24025

## ASHBURN, GA (CON'T)

### TURNER COUNTY (75J) (CON'T)

**Rwy 35**, tree 902' from DER, 736' left of centerline, 480' MSL.  
 Trees beginning 1113' from DER, 32' left of centerline, up to 498' MSL.  
 Tree 1331' from DER, 451' right of centerline, 474' MSL.  
 Tree 1343' from DER, 650' right of centerline, 475' MSL.  
 Tree 1384' from DER, 248' right of centerline, 478' MSL.  
 Trees beginning 1413' from DER, 118' right of centerline, up to 479' MSL.  
 Trees beginning 1513' from DER, 38' right of centerline, up to 484' MSL.  
 Tree 2721' from DER, 623' right of centerline, 487' MSL.  
 Trees, building beginning 2806' from DER, 71' right of centerline, up to 497' MSL.  
 Trees beginning 3689' from DER, 37' right of centerline, up to 509' MSL.  
 Light poles beginning 4046' from DER, 356' left of centerline, up to 84' AGL/508' MSL.  
 Sign 5913' from DER, 156' right of centerline, 159' AGL/577' MSL.  
 Antenna 1 NM from DER, 454' left of centerline, 177' AGL/615' MSL.  
 Tower 1.8 NM from DER, 477' right of centerline, 276' AGL/704' MSL.  
 Tower 1.8 NM from DER, 468' right of centerline, 285' AGL/716' MSL.

## ATHENS, GA

### ATHENS/BEN EPPS (AHN)

#### TAKEOFF MINIMUMS AND (OBSTACLE) DEPARTURE PROCEDURES

AMDT 2 15OCT15 (15288) (FAA)

##### DEPARTURE PROCEDURE:

**Rwy 2**, climb heading 027° to 2300 before turning west.

##### TAKEOFF OBSTACLE NOTES:

**Rwy 2**, multiple trees beginning 8' from DER, 495' right of centerline, up to 88' AGL/866' MSL.  
 Building 165' from DER, 393' left of centerline, 17' AGL/819' MSL.  
 Multiple poles beginning 652' from DER, 605' left of centerline, up to 38' AGL/832' MSL.  
 Multiple trees beginning 652' from DER, 617' left of centerline, up to 90' AGL/875' MSL.  
**Rwy 9**, tree 671' from DER, 631' left of centerline, 100' AGL/839' MSL.  
**Rwy 20**, multiple trees, terrain, and bushes beginning 41' from DER, 421' left of centerline, up to 108' AGL/873' MSL.  
 Multiple trees and terrain beginning 74' from DER, 403' right of centerline, up to 112' AGL/868' MSL.  
 Multiple poles beginning 359' from DER, 584' left of centerline, up to 51' AGL/822' MSL.  
 Poles beginning 656' from DER, 608' right of centerline, up to 35' AGL/803' MSL.  
 Building 1122' from DER, 285' left of centerline, 37' AGL/805' MSL.  
**Rwy 27**, fence 87' from DER, 255' left of centerline, 13' AGL/758' MSL.  
 Multiple trees beginning 106' from DER, 456' right of centerline, up to 104' AGL/807' MSL.  
 Multiple trees beginning 604' from DER, 638' left of centerline, up to 107' AGL/819' MSL.  
 Tower 1023' from DER, 365' left of centerline, 77' AGL/791' MSL.

## ATLANTA, GA

### ATLANTA RGNL FALCON FLD (FFC)

#### TAKEOFF MINIMUMS AND (OBSTACLE) DEPARTURE PROCEDURES

AMDT 2 10MAR11 (21168) (FAA)

##### TAKEOFF MINIMUMS:

**Rwy 31**, 300-1.

##### TAKEOFF OBSTACLE NOTES:

**Rwy 13**, trees beginning 960' from DER, 51' right of centerline, up to 98' AGL/877' MSL.  
 Trees beginning 377' from DER, 465' left of centerline, up to 88' AGL/887' MSL.  
**Rwy 31**, trees beginning 288' from DER, 538' right of centerline, up to 100' AGL/999' MSL.

### ATLANTA SPEEDWAY (HMP)

#### TAKEOFF MINIMUMS AND (OBSTACLE) DEPARTURE PROCEDURES

AMDT 2B 17JUN21 (21168) (FAA)

##### TAKEOFF OBSTACLE NOTES:

**Rwy 6**, vehicles on road, 249' from DER, crossing extended runway centerline, up to 914' MSL.  
 Tree 273' from DER, 502' left of centerline, 999' MSL.  
 Trees, beginning 1409' from DER, 145' left of centerline, up to 999' MSL.  
 Trees, beginning 1490' from DER, 3' right of centerline, up to 979' MSL.  
**Rwy 24**, trees, beginning 634' from DER, 169' right of centerline, up to 919' MSL.  
 Trees, beginning 1265' from DER, 168' left of centerline, up to 919' MSL.  
 Tree 1318' from DER, 466' right of centerline, 939' MSL.  
 Trees, beginning 1875' from DER, 15' left of centerline, up to 939' MSL.  
 Tree 3349' from DER, 654' left of centerline, 959' MSL.  
 T-1 tower 3401' from DER, 555' left of centerline, 969' MSL.  
 T-1 twr 3443' from DER, 336' right of centerline, 949' MSL.

# TAKEOFF MINIMUMS, (OBSTACLE) DEPARTURE PROCEDURES, AND DIVERSE VECTOR AREA (RADAR VECTORS)

24025

# TAKEOFF MINIMUMS, (OBSTACLE) DEPARTURE PROCEDURES, AND DIVERSE VECTOR AREA (RADAR VECTORS)

24025

## ATLANTA, GA (CON'T)

### COBB COUNTY INTL/MCCOLLUM FLD (RYY)

#### TAKEOFF MINIMUMS AND (OBSTACLE) DEPARTURE PROCEDURES

AMDT 2B 03JAN19 (21336) (FAA)

##### TAKEOFF MINIMUMS:

**Rwy 9**, 200-1% or std. w/min. climb of 223' per NM to 1400, or alternatively, with std. takeoff minimums and normal 200' per NM climb gradient, takeoff must occur no later than 1800' prior to DER.

**Rwy 27**, 300-1%.

##### DEPARTURE PROCEDURE:

**Rwy 9**, climb heading 093° to 1900 before proceeding south.

**Rwy 27**, climb heading 273° to 1600 before proceeding southeast.

##### TAKEOFF OBSTACLE NOTES:

**Rwy 9**, vertical structure 27' from DER, 376' right of centerline, 1005' MSL.

Vertical structure, tree beginning 1048' from DER, 559' left of centerline, up to 1039' MSL.

Tree 1880' from DER, 929' right of centerline, 1078' MSL.

Trees beginning 2265' from DER, 872' right of centerline, up to 1085' MSL.

Trees beginning 2472' from DER, 840' right of centerline, up to 1086' MSL.

**Rwy 27**, transmission line 81' from DER, 371' left of centerline, 25' AGL/1073' MSL.

Pole, building, terrain, fence beginning 81' from DER, 9' left of centerline, up to 1087' MSL.

Pole, terrain beginning 116' from DER, 177' right of centerline, up to 1079' MSL.

Pole 237' from DER, 449' right of centerline, 1081' MSL.

Tree 323' from DER, 429' left of centerline, 1088' MSL.

Pole beginning 376' from DER, 159' right of centerline, up to 1088' MSL.

Pole beginning 457' from DER, 262' right of centerline, up to 1090' MSL.

Pole, tree, building, traverse way beginning 524' from DER, 113' right of centerline, up to 1096' MSL.

Trees beginning 587' from DER, 36' left of centerline, up to 1095' MSL.

Tree, traverse way beginning 1267' from DER, 61' left of centerline up to 1106' MSL.

Tree, terrain beginning 1360' from DER, 25' right of centerline, up to 1137' MSL.

Pole, tree beginning 1436' from DER, 5' left of centerline, up to 1132' MSL.

Tree 1562' from DER, 905' right of centerline, 1142' MSL.

Sign, building, pole, terrain, tree beginning 1572' from DER, 122' right of centerline, up to 1160' MSL.

Tree, terrain beginning 1840' from DER, 15' left of centerline, up to 1137' MSL.

Pole, terrain beginning 1955' from DER, 72' right of centerline, up to 1176' MSL.

Sign 2068' from DER, 877' right of centerline, 1183' MSL.

Pole, tree, tower beginning 2090' from DER, 466' right of centerline, up to 1184' MSL.

Tree 2092' from DER, 850' left of centerline, 1146' MSL.

Tree, terrain, pole, building beginning 2106' from DER, 11' left of centerline, up to 1155' MSL.

Pole, terrain beginning 2302' from DER, 118' right of centerline, up to 1190' MSL.

Pole, terrain beginning 2418' from DER, 129' right of centerline, up to 1191' MSL.

Tree, pole beginning 2677' from DER, 185' right of centerline, up to 1199' MSL.

Tree 2798' from DER, 315' right of centerline, 1207' MSL.

Building, pole, terrain, vegetation beginning 2852' from DER, 246' left of centerline, up to 1156' MSL.

Trees beginning 2887' from DER, 172' right of centerline, up to 1214' MSL.

Tree, pole beginning 2999' from DER, 13' left of centerline, up to 1209' MSL.

Trees beginning 3083' from DER, 103' right of centerline, up to 1225' MSL.

Tree 3184' from DER, 23' left of centerline, 1213' MSL.

Trees beginning 3185' from DER, 32' left of centerline, up to 1215' MSL.

Trees beginning 4467' from DER, 101' left of centerline, up to 1197' MSL.

## COVINGTON MUNI (CVC)

#### TAKEOFF MINIMUMS AND (OBSTACLE) DEPARTURE PROCEDURES

AMDT 2 15NOV12 (12320) (FAA)

##### TAKEOFF MINIMUMS:

**Rwy 28**, 200-1 or std. w/min. climb of 259' per NM to 1100.

##### TAKEOFF OBSTACLE NOTES:

**Rwy 10**, terrain 19' from DER, 485' left of centerline, 817' MSL.

Trees beginning 1400' from DER, 301' left of centerline, up to 75' AGL/875' MSL.

Pole 988' from DER, 107' right of centerline, 34' AGL/844' MSL.

Tree 3903' from DER, 1535' right of centerline, 82' AGL/922' MSL.

**Rwy 28**, trees beginning 1066' from DER, 35' left of centerline, up to 115' AGL/ 875' MSL.

Trees beginning 2518' from DER, 144' left of centerline, up to 114' AGL/894' MSL.

Water tower 5029' from DER, 1580' left of centerline, 168' AGL/961' MSL.

Trees beginning 1287' from DER, 435' right of centerline, up to 128' AGL/888' MSL.

22 FEB 2024 to 21 MAR 2024

22 FEB 2024 to 21 MAR 2024

# TAKEOFF MINIMUMS, (OBSTACLE) DEPARTURE PROCEDURES, AND DIVERSE VECTOR AREA (RADAR VECTORS)

24025

# TAKEOFF MINIMUMS, (OBSTACLE) DEPARTURE PROCEDURES, AND DIVERSE VECTOR AREA (RADAR VECTORS)

24025

## ATLANTA, GA (CON'T)

### DEKALB-PEACHTREE (PDK)

#### TAKEOFF MINIMUMS AND (OBSTACLE) DEPARTURE PROCEDURES

AMDT 3A 12AUG21 (22111) (FAA)

#### TAKEOFF MINIMUMS:

**Rwys 3L, 21R**, NA-Environmental.

**Rwy 3R**, 200-1% or std. w/min. climb of 351' per NM to 1300.

**Rwy 21L**, std. w/min. climb of 211' per NM to 2000 or 1500-3 for VCOA.

**Rwy 34**, std. w/min. climb of 242' per NM to 1700 or 1500-3 for VCOA.

#### DEPARTURE PROCEDURE:

**Rwy 16**, climb on heading 162° to 2000 before proceeding on course.

**Rwy 21L**, climbing left turn on heading 150° to 3000 before turning right.

#### VCOA:

**Rwys 21L, 34**, obtain ATC approval for VCOA when requesting IFR clearance. Climb in visual conditions to cross Dekalb-Peachtree airport at or above 2300 before proceeding on course.

#### TAKEOFF OBSTACLE NOTES:

**Rwy 16**, sign, lighting, terrain beginning 2' from DER, 145' right of centerline, up to 5' AGL/997' MSL.

Tower, sign, antennas, lighting beginning 10' from DER, 144' left of centerline, up to 29' AGL/1017' MSL.

Pole, wind indicator, tree beginning 78' from DER, 57' right of centerline, up to 13' AGL/1002' MSL.

Trees beginning 122' from DER, 71' left of centerline, up to 1031' MSL.

Trees beginning 231' from DER, 35' left of centerline, up to 1041' MSL.

Trees beginning 364' from DER, 14' right of centerline, up to 1014' MSL.

Trees beginning 686' from DER, 77' right of centerline, up to 1018' MSL.

Trees beginning 739' from DER, 47' right of centerline, up to 1032' MSL.

Trees beginning 818' from DER, 25' right of centerline, up to 1051' MSL.

Trees beginning 1171' from DER, 254' right of centerline, up to 1053' MSL.

Tree, sign beginning 1361' from DER, 226' right of centerline, up to 1055' MSL.

Tree 1442' from DER, 146' right of centerline, 1062' MSL.

Tree 1524' from DER, 325' right of centerline, 1063' MSL.

Trees beginning 1555' from DER, 75' right of centerline, up to 1066' MSL.

Trees beginning 1746' from DER, 504' right of centerline, up to 1080' MSL.

Trees beginning 1777' from DER, 56' right of centerline, up to 1089' MSL.

Tree 2302' from DER, 1099' left of centerline, 1055' MSL.

**Rwy 3R**, sign 20' from DER, 252' left of centerline, 3' AGL/985' MSL.

Lighting 59' from DER, on centerline, 6' AGL/987' MSL.

Lighting 59' from DER, 28' left of centerline, 6' AGL/987' MSL.

Tree 63' from DER, 358' right of centerline, 1004' MSL.

Trees, pole beginning 179' from DER, 204' right of centerline, up to 1009' MSL.

Tree, poles beginning 406' from DER, 358' left of centerline, up to 1026' MSL.

Trees, poles beginning 559' from DER, 46' left of centerline, up to 1043' MSL.

Trees, poles beginning 624' from DER, 15' right of centerline, up to 1023' MSL.

Trees beginning 790' from DER, 76' left of centerline, up to 1065' MSL.

Trees beginning 938' from DER, 38' right of centerline, up to 1030' MSL.

Tree 1171' from DER, 51' right of centerline, 1038' MSL.

Trees beginning 1410' from DER, 21' left of centerline, up to 1071' MSL.

Trees, poles beginning 1488' from DER, 133' right of centerline, up to 1050' MSL.

Trees, pole beginning 1798' from DER, 39' right of centerline, up to 1071' MSL.

Tree 1927' from DER, 693' left of centerline, 1086' MSL.

Trees beginning 1928' from DER, 25' left of centerline, up to 1103' MSL.

Trees beginning 2120' from DER, 66' right of centerline, up to 1082' MSL.

Trees beginning 2316' from DER, 377' right of centerline, up to 1098' MSL.

Trees beginning 2399' from DER, 80' right of centerline, up to 1107' MSL.

Trees, vehicles on road beginning 2616' from DER, on centerline, up to 1105' MSL.

Trees beginning 3353' from DER, 146' right of centerline, up to 1114' MSL.

Tree 3711' from DER, 1463' left of centerline, 1130' MSL.

Trees beginning 3768' from DER, 12' left of centerline, up to 1148' MSL.

Trees beginning 3784' from DER, 976' right of centerline, up to 1120' MSL.

Trees, vehicles on road beginning 3883' from DER, 83' left of centerline, up to 1150' MSL.

Trees, pole beginning 3914' from DER, 186' right of centerline, up to 1126' MSL.

Trees beginning 4195' from DER, 164' right of centerline, up to 1133' MSL.

Trees beginning 4358' from DER, 213' right of centerline, up to 1138' MSL.

Trees beginning 4556' from DER, 422' right of centerline, up to 1140' MSL.

Trees beginning 4809' from DER, 70' right of centerline, up to 1145' MSL.

Pole 1 NM from DER, 2104' right of centerline, 94' AGL/1161' MSL.

**Rwy 21L**, lighting 25' from DER, 90' left of centerline, 4' AGL/998' MSL.

Lighting 25' from DER, 89' right of centerline, 5' AGL/998' MSL.

Trees, pole beginning 27' from DER, 387' left of centerline, up to 1040' MSL.

Trees, spire beginning 373' from DER, 329' left of centerline, up to 1045' MSL.

Trees beginning 874' from DER, 562' left of centerline, up to 1061' MSL.

Trees, sign beginning 1151' from DER, 270' left of centerline, up to 1067' MSL.

Trees, sign beginning 1214' from DER, 279' left of centerline, up to 1070' MSL.

Trees beginning 1356' from DER, 563' right of centerline, up to 1039' MSL.

Trees beginning 1429' from DER, 352' left of centerline, up to 1071' MSL.

Tree 1633' from DER, 775' right of centerline, 1043' MSL.

Tree, spire beginning 1954' from DER, 840' right of centerline, up to 1051' MSL.

CON'T

# TAKEOFF MINIMUMS, (OBSTACLE) DEPARTURE PROCEDURES, AND DIVERSE VECTOR AREA (RADAR VECTORS)

24025

# TAKEOFF MINIMUMS, (OBSTACLE) DEPARTURE PROCEDURES, AND DIVERSE VECTOR AREA (RADAR VECTORS)

24025

## ATLANTA, GA (CON'T)

### DEKALB-PEACHTREE (PDK) (CON'T)

**Rwy 21L (CON'T)**, tree 2086' from DER, 764' right of centerline, 1055' MSL.  
 Antenna 3070' from DER, 533' right of centerline, 101' AGL/1085' MSL.  
**Rwy 34**, trees, pole beginning 3' from DER, 285' left of centerline, up to 1041' MSL.  
 Trees beginning 224' from DER, 368' left of centerline, up to 1067' MSL.  
 Building 340' from DER, 423' right of centerline, 28' AGL/1022' MSL.  
 Trees, pole beginning 349' from DER, 411' left of centerline, up to 1096' MSL.  
 Trees, poles, vehicles on road, tower, building, signs beginning 480' from DER, 15' left of centerline, up to 1101' MSL.  
 Building 693' from DER, 397' right of centerline, 31' AGL/1026' MSL.  
 Fence 838' from DER, 721' right of centerline, 10' AGL/1028' MSL.  
 Tree 910' from DER, 506' right of centerline, 1039' MSL.  
 Poles, trees, fence beginning 956' from DER, 196' right of centerline, up to 30' AGL/1052' MSL.  
 Poles, vehicles on road, trees beginning 1102' from DER, 54' right of centerline, up to 37' AGL/1056' MSL.  
 Poles, trees, vehicles on road, lighting beginning 1184' from DER, 9' right of centerline, up to 34' AGL/1057' MSL.  
 Poles, tree beginning 1256' from DER, 206' right of centerline, up to 37' AGL/1059' MSL.  
 Sign, poles, lighting, tree, vehicles on road, building beginning 1286' from DER, 21' right of centerline, up to 47' AGL/1074' MSL.  
 Trees, poles, vehicles on road, buildings beginning 1482' from DER, 1' left of centerline, up to 1111' MSL.  
 Tree 1693' from DER, 74' right of centerline, 1079' MSL.  
 Trees beginning 1711' from DER, 177' right of centerline, up to 1081' MSL.  
 Trees, building, vehicles on road beginning 1724' from DER, 3' right of centerline, up to 1083' MSL.  
 Trees, vehicles on road, pole, buildings beginning 1774' from DER, 33' right of centerline, up to 1089' MSL.  
 Trees beginning 2530' from DER, 7' right of centerline, up to 1092' MSL.  
 Trees beginning 3994' from DER, 1109' left of centerline, up to 1116' MSL.  
 Tree 4535' from DER, 1658' right of centerline, 1122' MSL.

## FULTON COUNTY EXEC/CHARLIE BROWN FLD (FTY)

### TAKEOFF MINIMUMS AND (OBSTACLE) DEPARTURE PROCEDURES

AMDT 8 08NOV18 (21168) (FAA)

#### TAKEOFF MINIMUMS:

**Rwy 8**, 300-2 or std. w/min. climb of 335' per NM to 1200.  
**Rwy 14**, 300-2 or std. w/min. climb of 1020' per NM to 1100.  
**Rwy 26**, std. w/min. climb of 300' per NM to 1400.  
**Rwy 32**, std. w/min. climb of 330' per NM to 1500.

#### DEPARTURE PROCEDURE:

**Rwy 8**, climbing left turn on heading 060° to 2800 before proceeding on course.  
**Rwy 14**, climb on heading 144° to 1700 before proceeding on course.

#### TAKEOFF OBSTACLE NOTES:

**Rwy 8**, pole and tree beginning 9' from DER, 208' left of centerline, up to 16' AGL/828' MSL.  
 Building and tree beginning 155' from DER, 317' right of centerline, up to 17' AGL/828' MSL.  
 Trees beginning 177' from DER, 305' left of centerline, up to 845' MSL.  
 Trees beginning 254' from DER, 333' left of centerline, up to 849' MSL.  
 Trees beginning 371' from DER, 402' right of centerline, up to 873' MSL.  
 Trees beginning 666' from DER, 287' left of centerline, up to 852' MSL.  
 Tree 857' from DER, 714' right of centerline, 894' MSL.  
 Tree 983' from DER, 429' right of centerline, 895' MSL.  
 Tree 1092' from DER, 771' right of centerline, 907' MSL.  
 Tree 1405' from DER, 522' right of centerline, 918' MSL.  
 Trees beginning 1437' from DER, 255' right of centerline, up to 937' MSL.  
 Tree 1592' from DER, 491' left of centerline, 863' MSL.  
 Trees beginning 1669' from DER, 457' right of centerline, up to 946' MSL.  
 Tree 1773' from DER, 535' left of centerline, 877' MSL.  
 Trees and transmission line beginning 1889' from DER, crossing extended runway centerline, up to 952' MSL.  
 Trees beginning 1890' from DER, 495' left of centerline, up to 897' MSL.  
 Trees beginning 2032' from DER, 331' left of centerline, up to 905' MSL.  
 Trees beginning 2241' from DER, 572' left of centerline, up to 917' MSL.  
 Trees beginning 3767' from DER, 464' left of centerline, up to 951' MSL.  
 Trees beginning 3872' from DER, 362' left of centerline, up to 958' MSL.  
 Antenna and trees beginning 3942' from DER, 59' left of centerline, up to 160' AGL/979' MSL.  
 Sign and trees beginning 4382' from DER, 160' right of centerline, up to 146' AGL/972' MSL.  
 Signs and trees beginning 4958' from DER, 15' left of centerline, up to 127' AGL/995' MSL.  
 Trees beginning 5373' from DER, 25' right of centerline, up to 985' MSL.  
 Tree 5550' from DER, 1751' right of centerline, 999' MSL.  
 Trees beginning 5579' from DER, 34' right of centerline, up to 1005' MSL.  
 Trees beginning 1 NM from DER, 353' right of centerline, up to 1013' MSL.  
 Sign and trees beginning 1 NM from DER, 132' left of centerline, up to 118' AGL/1007' MSL.  
 Tree 1 NM from DER, 531' right of centerline, 1026' MSL.  
 Trees and building beginning 1 NM from DER, 698' right of centerline, up to 1036' MSL.  
 Tree 1 NM from DER, 1640' right of centerline, 1040' MSL.  
 Trees beginning 1 NM from DER, 82' right of centerline, up to 1057' MSL.  
 Trees beginning 1.1 NM from DER, 85' right of centerline, up to 1064' MSL.  
 Trees beginning 1.1 NM from DER, 533' right of centerline, up to 1068' MSL.  
 Trees beginning 1.1 NM from DER, 734' right of centerline, up to 1074' MSL.  
 Tree 1.1 NM from DER, 1121' left of centerline, 1010' MSL.

CON'T

# TAKEOFF MINIMUMS, (OBSTACLE) DEPARTURE PROCEDURES, AND DIVERSE VECTOR AREA (RADAR VECTORS)

24025

# TAKEOFF MINIMUMS, (OBSTACLE) DEPARTURE PROCEDURES, AND DIVERSE VECTOR AREA (RADAR VECTORS)

24025

## ATLANTA, GA (CON'T)

### FULTON COUNTY EXEC/CHARLIE BROWN FLD (FTY) (CON'T)

**Rwy 8 (CON'T)**, trees beginning 1.1 NM from DER, 838' right of centerline, up to 1076' MSL.  
 Antenna, towers, and trees beginning 1.2 NM from DER, 38' right of centerline, up to 165' AGL/1109' MSL.  
 Building and tree beginning 1.3 NM from DER, 92' left of centerline, up to 64' AGL/1033' MSL.  
 Trees beginning 1.4 NM from DER, 90' left of centerline, up to 1052' MSL.  
 Tree 1.4 NM from DER, 28' left of centerline, 1053' MSL.  
 Trees beginning 1.4 NM from DER, 107' left of centerline, up to 1055' MSL.  
 Tree 1.5 NM from DER, 3009' right of centerline, 1051' MSL.  
**Rwy 14**, trees, buildings, signs, poles, and towers beginning 181' from DER, 2' left of centerline, up to 926' MSL.  
 Pole 420' from DER, 355' right of centerline, 30' AGL/871' MSL.  
 Pole and vehicles on road beginning 448' from DER, crossing extended runway centerline, up to 39' AGL/885' MSL.  
 Trees and tower beginning 607' from DER, 172' right of centerline, up to 912' MSL.  
 Poles, sign, and trees beginning 845' from DER, 96' left of centerline, up to 945' MSL.  
 Trees beginning 945' from DER, 76' right of centerline, up to 945' MSL.  
 Trees beginning 1226' from DER, 369' left of centerline, up to 971' MSL.  
 Tree 1280' from DER, 794' left of centerline, 1002' MSL.  
 Trees and poles beginning 1311' from DER, 21' left of centerline, up to 1008' MSL.  
 Trees beginning 1808' from DER, 242' right of centerline, up to 953' MSL.  
 Trees beginning 2001' from DER, 36' right of centerline, up to 975' MSL.  
 Trees beginning 2220' from DER, 132' right of centerline, up to 983' MSL.  
 Signs, trees, poles, and buildings beginning 2383' from DER, 21' right of centerline, up to 144' AGL/1034' MSL.  
 Trees and fence beginning 2991' from DER, crossing extended runway centerline, up to 1011' MSL.  
 Trees beginning 3634' from DER, 409' left of centerline, up to 1015' MSL.  
 Trees beginning 3665' from DER, 395' left of centerline, up to 1037' MSL.  
 Trees beginning 3862' from DER, 654' left of centerline, up to 1041' MSL.  
 Trees and buildings beginning 3948' from DER, 128' left of centerline, up to 1054' MSL.  
 Trees beginning 4202' from DER, 885' left of centerline, up to 1066' MSL.  
 Trees, tank, poles, and towers beginning 4296' from DER, 37' left of centerline, up to 1070' MSL.  
 Trees beginning 4420' from DER, 9' right of centerline, up to 1042' MSL.  
 Trees beginning 5016' from DER, 55' right of centerline, up to 1047' MSL.  
 Trees beginning 5767' from DER, 136' right of centerline, up to 1050' MSL.  
 Trees beginning 1.2 NM from DER, 97' right of centerline, up to 1060' MSL.  
 Trees beginning 1.3 NM from DER, 1327' right of centerline, up to 1064' MSL.  
 Trees beginning 1.3 NM from DER, 1728' right of centerline, up to 1067' MSL.  
 Antennas and tower beginning 1.5 NM from DER, 605' left of centerline, up to 200' AGL/1099' MSL.  
 Tower 1.5 NM from DER, 821' left of centerline, 200' AGL/1094' MSL.  
**Rwy 26**, trees beginning 30' from DER, 242' right of centerline, up to 824' MSL.  
 Trees beginning 43' from DER, 471' left of centerline, up to 828' MSL.  
 Trees beginning 498' from DER, 282' right of centerline, up to 841' MSL.  
 Trees beginning 709' from DER, 331' right of centerline, up to 848' MSL.  
 Tree 773' from DER, 357' left of centerline, 833' MSL.  
 Trees beginning 780' from DER, 485' left of centerline, up to 839' MSL.  
 Trees beginning 960' from DER, 327' left of centerline, up to 855' MSL.  
 Trees beginning 1066' from DER, 574' right of centerline, up to 858' MSL.  
 Tree 1159' from DER, 535' left of centerline, 863' MSL.  
 Trees beginning 1323' from DER, 229' left of centerline, up to 867' MSL.  
 Tree 2209' from DER, 662' right of centerline, 878' MSL.  
 Trees beginning 2224' from DER, 704' right of centerline, up to 889' MSL.  
 Trees beginning 2405' from DER, 758' right of centerline, up to 910' MSL.  
 Tree 3366' from DER, 917' right of centerline, 915' MSL.  
 Tree 3373' from DER, 1368' right of centerline, 920' MSL.  
 Tree 3431' from DER, 1166' right of centerline, 921' MSL.  
 Trees beginning 3489' from DER, 761' right of centerline, up to 924' MSL.  
 Tower 5158' from DER, 25' left of centerline, 151' AGL/929' MSL.  
**Rwy 32**, trees and fence beginning 76' from DER, crossing extended runway centerline, up to 828' MSL.  
 Tree 108' from DER, 504' left of centerline, 824' MSL.  
 Tree 333' from DER, 524' right of centerline, 846' MSL.  
 Tree 517' from DER, 168' left of centerline, 832' MSL.  
 Tree 580' from DER, 292' left of centerline, 836' MSL.  
 Trees beginning 627' from DER, 18' left of centerline, up to 849' MSL.  
 Trees beginning 729' from DER, 61' right of centerline, up to 858' MSL.  
 Tree 1730' from DER, 943' right of centerline, 864' MSL.  
 Tree 1864' from DER, 299' left of centerline, 851' MSL.  
 Tree 1880' from DER, 241' left of centerline, 853' MSL.  
 Trees beginning 2082' from DER, 869' left of centerline, up to 908' MSL.  
 Tree 2721' from DER, 968' right of centerline, 876' MSL.  
 Trees beginning 2834' from DER, 529' right of centerline, up to 894' MSL.  
 Tree 2937' from DER, 1063' left of centerline, 931' MSL.  
 Trees beginning 2953' from DER, 72' left of centerline, up to 941' MSL.  
 Tree 3111' from DER, 675' right of centerline, 897' MSL.  
 Trees beginning 3134' from DER, 436' right of centerline, up to 916' MSL.  
 Trees beginning 3618' from DER, 994' right of centerline, up to 917' MSL.  
 Tree 3707' from DER, 907' right of centerline, 923' MSL.  
 Trees beginning 3758' from DER, 978' right of centerline, up to 924' MSL.

CON'T

22 FEB 2024 to 21 MAR 2024

22 FEB 2024 to 21 MAR 2024

# TAKEOFF MINIMUMS, (OBSTACLE) DEPARTURE PROCEDURES, AND DIVERSE VECTOR AREA (RADAR VECTORS)

24025

SE-4

# TAKEOFF MINIMUMS, (OBSTACLE) DEPARTURE PROCEDURES, AND DIVERSE VECTOR AREA (RADAR VECTORS)

24025

## ATLANTA, GA (CON'T)

### FULTON COUNTY EXEC/CHARLIE BROWN FLD (FTY) (CON'T)

**Rwy 32 (CON'T)**, trees beginning 3845' from DER, 1042' right of centerline, up to 940' MSL.

Trees beginning 3964' from DER, 157' left of centerline, up to 946' MSL.

Trees beginning 4087' from DER, 54' right of centerline, up to 947' MSL.

Trees beginning 4554' from DER, 218' left of centerline, up to 950' MSL.

### HARTSFIELD-JACKSON ATLANTA INTL (ATL)

#### TAKEOFF MINIMUMS AND (OBSTACLE) DEPARTURE PROCEDURES

AMDT 8 10SEP20 (20254) (FAA)

##### TAKEOFF MINIMUMS:

**Rwy 9L**, 300-1 or std. w/min. climb of 270' per NM to 1200.

##### DEPARTURE PROCEDURE:

**Rwy 8R**, climb on heading 095° to 1500 before turning right.

**Rwy 9L**, climb on heading 095° to 1400 before turning left.

##### TAKEOFF OBSTACLE NOTES:

**Rwy 8L**, trees beginning 855' from DER, 626' left of centerline, up to 62' AGL/1030' MSL.

Trees beginning 930' from DER, 533' left of centerline, up to 1048' MSL.

**Rwy 8R**, tree 345' from DER, 586' left of centerline, 57' AGL/1006' MSL.

Tree 510' from DER, 503' left of centerline, 68' AGL/1013' MSL.

Tower 4821' from DER, 1634' right of centerline, 139' AGL/1138' MSL.

**Rwy 9L**, pole and antenna beginning 4805' from DER, 1729' left of centerline, up to 141' AGL/1137' MSL.

**Rwy 10**, poles beginning 58' from DER, 467' right of centerline, up to 41' AGL/1016' MSL.

**Rwy 26L**, building 1249' from DER, 751' left of centerline, 45' AGL/1059' MSL.

Pole 1895' from DER, 964' left of centerline, 66' AGL/1079' MSL.

Trees beginning 2797' from DER, 563' left of centerline, up to 61' AGL/1097' MSL.

Trees beginning 2897' from DER, 468' left of centerline, up to 70' AGL/1103' MSL.

**Rwy 26R**, pole 531' from DER, 619' right of centerline, 36' AGL/1032' MSL.

Tree 1749' from DER, 908' right of centerline, 40' AGL/1073' MSL.

Trees and poles beginning 1797' from DER, 122' right of centerline, up to 1081' MSL.

Tree 1988' from DER, 486' left of centerline, 1067' MSL.

Trees beginning 2334' from DER, 386' left of centerline, up to 58' AGL/1077' MSL.

Tree 2648' from DER, 1185' right of centerline, 60' AGL/1099' MSL.

Tree 2680' from DER, 127' left of centerline, 1086' MSL.

Trees beginning 2808' from DER, 131' left of centerline, up to 1091' MSL.

Tree 2880' from DER, 863' left of centerline, 61' AGL/1093' MSL.

Trees beginning 2945' from DER, 840' left of centerline, up to 53' AGL/1102' MSL.

Trees beginning 3048' from DER, 61' left of centerline, up to 55' AGL/1103' MSL.

Pole 3195' from DER, 998' right of centerline, 48' AGL/1101' MSL.

Tree 3341' from DER, 695' right of centerline, 56' AGL/1103' MSL.

Tree 3369' from DER, 501' right of centerline, 1104' MSL.

Towers and trees beginning 3381' from DER, 111' right of centerline, up to 71' AGL/1128' MSL.

Tree 3586' from DER, 1082' left of centerline, 55' AGL/1105' MSL.

Tree 3631' from DER, 1066' left of centerline, 56' AGL/1106' MSL.

Trees beginning 3685' from DER, 1031' left of centerline, up to 66' AGL/1113' MSL.

Antenna, trees and pole beginning 4140' from DER, 689' right of centerline, up to 101' AGL/1137' MSL.

**Rwy 27L**, elevator 3937' from DER, 1256' right of centerline, 103' AGL/1129' MSL.

**Rwy 27R**, terrain 17' from DER, 287' left of centerline, 1020' MSL.

Terrain 17' from DER, 413' left of centerline, 1022' MSL.

Signs beginning 58' from DER, 292' left of centerline, up to 4' AGL/1024' MSL.

Pole 1011' from DER, 730' right of centerline, 32' AGL/1046' MSL.

Agricultural equipment 3567' from DER, 864' right of centerline, 89' AGL/1113' MSL.

Agricultural equipment 3674' from DER, 491' right of centerline, 96' AGL/1119' MSL.

Elevator 3937' from DER, 203' right of centerline, 103' AGL/1129' MSL.

Tree 4387' from DER, 999' right of centerline, 1141' MSL.

**Rwy 28**, tree and catenary beginning 1949' from DER, 769' left of centerline, up to 39' AGL/1055' MSL.

Tree 2026' from DER, 997' left of centerline, 50' AGL/1059' MSL.

Sign 2428' from DER, 1026' left of centerline, 63' AGL/1067' MSL.

Trees beginning 3158' from DER, 1208' left of centerline, up to 85' AGL/1097' MSL.

## NEWMAN COWETA COUNTY (CCO)

#### TAKEOFF MINIMUMS AND (OBSTACLE) DEPARTURE PROCEDURES

AMDT 3C 16JUL20 (20198) (FAA)

##### DEPARTURE PROCEDURE:

**Rwy 33**, climbing left turn on heading 270° to 2100 before proceeding on course.

##### TAKEOFF OBSTACLE NOTES:

**Rwy 15**, trees beginning 832' from DER, 346' left of centerline, up to 100' AGL/999' MSL.

Trees beginning 253' from DER, 443' right of centerline, up to 100' AGL/944' MSL.

**Rwy 33**, trees beginning 975' from DER, 21' right of centerline, up to 100' AGL/1051' MSL.

Utility tower 1063' from DER, 320' right of centerline, 65' AGL/997' MSL.

Fence 1286' from DER, 550' right of centerline, 25' AGL/1005' MSL.

Trees beginning 167' from DER, 1' left of centerline, up to 100' AGL/1048' MSL.

Utility towers beginning 135' from DER, 36' left of centerline, up to 65' AGL/1032' MSL.

Tree 1684' from DER, 784' right of centerline, 100' AGL/1119' MSL.

# TAKEOFF MINIMUMS, (OBSTACLE) DEPARTURE PROCEDURES, AND DIVERSE VECTOR AREA (RADAR VECTORS)

24025



**TAKEOFF MINIMUMS, (OBSTACLE) DEPARTURE PROCEDURES, AND  
DIVERSE VECTOR AREA (RADAR VECTORS)**

24025

**ATLANTA, GA (CON'T)****PAULDING-NORTHWEST ATLANTA (PUJ)****TAKEOFF MINIMUMS AND (OBSTACLE) DEPARTURE PROCEDURES**

AMDT 1 05MAY11 (11125) (FAA)

**TAKEOFF OBSTACLE NOTES:****Rwy 31**, trees beginning 213' from DER, left and right of centerline, up to 100' AGL/1399' MSL.

Trees beginning 4202' from DER, left and right of centerline, up to 100' AGL/1419' MSL.

**ATMORE, AL****ATMORE MUNI (0R1)****TAKEOFF MINIMUMS AND (OBSTACLE) DEPARTURE PROCEDURES**

AMDT 2 01FEB18 (18032) (FAA)

**TAKEOFF OBSTACLE NOTES:****Rwy 18**, tree 8' from DER, 303' left of centerline, 50' AGL/323' MSL.

Pole, vehicle on road beginning 77' from DER, 324' right of centerline, up to 309' MSL.

Tree, transmission line beginning 206' from DER, 65' right of centerline, up to 70' AGL/351' MSL.

Tree, transmission line, pole beginning 222' from DER, 57' left of centerline, up to 72' AGL/351' MSL.

Trees beginning 2841' from DER, 156' right of centerline, up to 359' MSL.

**Rwy 36**, vehicle on road 4' from DER, 227' left of centerline, 297' MSL.

Tree, building beginning 75' from DER, 231' left of centerline, up to 305' MSL.

Tree 76' from DER, 354' right of centerline, 303' MSL.

Tree, vegetation beginning 76' from DER, 300' right of centerline, up to 34' AGL/317' MSL.

Building 282' from DER, 239' left of centerline, up to 308' MSL.

Tree 449' from DER, 427' left of centerline, 323' MSL.

Tree, pole beginning 464' from DER, 12' left of centerline, up to 341' MSL.

Tree 564' from DER, 553' right of centerline, 324' MSL.

Tree, pole beginning 663' from DER, 571' right of centerline, up to 346' MSL.

Vehicles on road 834' from DER, crossing centerline, up to 346' MSL.

Tree 2385' from DER, 1104' left of centerline, 347' MSL.

Tree 2612' from DER, 1116' left of centerline, 349' MSL.

**AUBURN, AL****AUBURN UNIVERSITY RGNL (AUO)****TAKEOFF MINIMUMS AND (OBSTACLE) DEPARTURE PROCEDURES**

AMDT 1A 10NOV16 (16315) (FAA)

**TAKEOFF OBSTACLE NOTES:****Rwy 18**, tree 1127' from DER, 724' right of centerline, 769' MSL.

Tree 1555' from DER, 659' right of centerline, 793' MSL.

**Rwy 29**, tree 201' from DER, 505' left of centerline, 836' MSL.

Trees beginning 231' from DER, 407' right of centerline, up to 828' MSL.

Trees beginning 428' from DER, 312' left of centerline, up to 850' MSL.

Tree and poles beginning 543' from DER, 327' right of centerline, up to 830' MSL.

Trees beginning 600' from DER, 347' left of centerline, up to 857' MSL.

Trees beginning 660' from DER, 561' right of centerline, up to 841' MSL.

Trees beginning 1259' from DER, 521' left of centerline, up to 860' MSL.

**Rwy 36**, terrain beginning 87' from DER, 392' right of centerline, up to 781' MSL.

Tree 196' from DER, 377' right of centerline, 784' MSL.

Tree 223' from DER, 507' left of centerline, 828' MSL.

Trees beginning 371' from DER, 467' right of centerline, up to 855' MSL.

Trees beginning 765' from DER, 265' right of centerline, up to 861' MSL.

Tree 1113' from DER, 603' left of centerline, 831' MSL.

22 FEB 2024 to 21 MAR 2024

22 FEB 2024 to 21 MAR 2024

**TAKEOFF MINIMUMS, (OBSTACLE) DEPARTURE PROCEDURES, AND  
DIVERSE VECTOR AREA (RADAR VECTORS)**

24025

SE-4

# TAKEOFF MINIMUMS, (OBSTACLE) DEPARTURE PROCEDURES, AND DIVERSE VECTOR AREA (RADAR VECTORS)

24025

## AUGUSTA, GA

### AUGUSTA RGNL AT BUSH FLD (AGS)

#### TAKEOFF MINIMUMS AND (OBSTACLE) DEPARTURE PROCEDURES

AMDT 14 26JUL12 (21168) (FAA)

##### TAKEOFF MINIMUMS:

**Rwy 8**, std. w/min. climb of 391' per NM to 2600 or 1700-2½ for climb in visual conditions.

**Rwy 17**, 200-1½ or std. w/min. climb of 268' per NM to 500.

**Rwy 26**, 300-1¼ or std. w/min. climb of 324' per NM to 600.

##### DEPARTURE PROCEDURE:

**Rwy 8**, for climb in visual conditions: cross Augusta Rgnl at Bush Fld airport at or above 1700 before proceeding on course.

When executing VCOA, notify ATC prior to departure.

**Rwy 17**, climb heading 172° to 900 before turning left.

**Rwy 26**, climb heading 262° to 1000 before proceeding on course.

**Rwy 35**, climb heading 352° to 1200 before turning right.

##### TAKEOFF OBSTACLE NOTES:

**Rwy 8**, trees 2011' from DER, 379' left of centerline, up to 100' AGL/209' MSL.

**Rwy 17**, bush 746' from DER, 616' left of centerline, up to 14' AGL/158' MSL.

Trees beginning 1700' from DER, left and right of centerline, up to 100' AGL/339' MSL.

**Rwy 26**, trees beginning 992' from DER, 294' left of center line, up to 100' AGL/355' MSL.

Trees beginning 1254' from DER, 175' right of centerline, up to 100' AGL/419' MSL.

Building 1344' from DER, 436' left of centerline, up to 31' AGL/175' MSL.

Light pole 1015' from DER, 287' right of centerline, up to 31' AGL/175' MSL.

## DANIEL FLD (DNL)

#### TAKEOFF MINIMUMS AND (OBSTACLE) DEPARTURE PROCEDURES

AMDT 6 24JUL14 (21168) (FAA)

##### TAKEOFF MINIMUMS:

**Rwy 23**, std. w/min. climb of 250' per NM to 800.

##### DEPARTURE PROCEDURE:

**Rwy 23**, climb heading 215° to 1300 before turning right.

**Rwy 29**, climb heading 288° to 1000 before turning left.

##### TAKEOFF OBSTACLE NOTES:

**Rwy 8**, vehicles on road, poles, trees, signs, and wall beginning 16' from DER 1' left of centerline, up to 65' AGL/472' MSL.

Poles, trees, signs, buildings, and wall beginning 175' from DER, 40' right of centerline, up to 50' AGL/475' MSL.

Trees, buildings, and poles beginning 591' from DER, 37' left of centerline, up to 65' AGL/492' MSL.

Trees, poles, and building beginning 873' from DER, 170' right of centerline, up to 63' AGL/490' MSL.

Poles, trees, tanks, and buildings beginning 1008' from DER, left and right of centerline, up to 90' AGL/508' MSL.

Poles, trees, and buildings beginning 1353' from DER, left and right of centerline, up to 95' AGL/525' MSL.

Poles, trees, and buildings beginning 1567' from DER, left and right of centerline, up to 95' AGL/540' MSL.

Poles, trees, buildings, and towers beginning 2287' from DER, left and right of centerline, up to 135' AGL/557' MSL.

**Rwy 11**, poles, trees, and buildings beginning 177' from DER, 360' left of centerline, up to 35' AGL/453' MSL.

Trees and pole beginning 188' from DER, 479' right of centerline, up to 53' AGL/472' MSL.

Vehicles on road, trees, poles, and buildings beginning 276' from DER, 2' right of centerline, up to 65' AGL/476' MSL.

Trees, buildings, poles, and sign beginning 343' from DER, 10' left of centerline, up to 65' AGL/476' MSL.

Poles, trees, and buildings beginning 620' from DER, 11' right of centerline, up to 75' AGL/485' MSL.

Poles, trees, and building beginning 845' from DER, 7' left of centerline, up to 80' AGL/491' MSL.

Pole, building, and trees beginning 1109' from DER, 9' right of centerline, up to 85' AGL/495' MSL.

Building 2240' from DER, 518' right of centerline, 106' AGL/509' MSL.

**Rwy 23**, trees beginning 9' from DER, 141' right of centerline, up to 30' AGL/402' MSL.

Trees beginning 11' from DER, 195' left of centerline, up to 25' AGL/398' MSL.

Trees beginning 105' from DER, left and right of centerline, up to 112' AGL/430' MSL.

**Rwy 29**, trees, buildings, and poles beginning from DER, 192' right of centerline, up to 75' AGL/508' MSL.

Vehicles on road, trees, buildings, pole, and sign beginning 4' from DER, 131' left of centerline, up to 40' AGL/472' MSL.

Trees and poles beginning 354' from DER, 22' right of centerline, up to 95' AGL/535' MSL.

Tower and trees beginning 879' from DER, 6' left of centerline, up to 80' AGL/501' MSL.

## BAINBRIDGE, GA

### DECATUR COUNTY INDUSTRIAL AIR PARK (BGE)

#### TAKEOFF MINIMUMS AND (OBSTACLE) DEPARTURE PROCEDURES

ORIG 30JUL09 (09211) (FAA)

##### TAKEOFF OBSTACLE NOTES:

**Rwy 14**, trees beginning 938' from DER, 238' right of centerline, up to 100' AGL/249' MSL.

**Rwy 27**, trees beginning 1050' from DER, 52' right of centerline, up to 100' AGL/196' MSL.

Tree 1527' from DER, 63' left of centerline, 100' AGL/192' MSL.

# TAKEOFF MINIMUMS, (OBSTACLE) DEPARTURE PROCEDURES, AND DIVERSE VECTOR AREA (RADAR VECTORS)

24025

# TAKEOFF MINIMUMS, (OBSTACLE) DEPARTURE PROCEDURES, AND DIVERSE VECTOR AREA (RADAR VECTORS)

24025

## BAXLEY, GA

### BAXLEY MUNI (BHC)

#### TAKEOFF MINIMUMS AND (OBSTACLE) DEPARTURE PROCEDURES

AMDT 1 31MAY12 (12152) (FAA)

#### DEPARTURE PROCEDURE:

**Rwy 26**, climb heading 261° to 800 before turning north.

#### TAKEOFF OBSTACLE NOTES:

**Rwy 8**, trees beginning 13' from DER, 149' left of centerline, up to 70' AGL/285' MSL.

Trees beginning 749' from DER, 465' right of centerline, up to 97' AGL/278' MSL.

Poles beginning 764' from DER, 392' right of centerline, up to 24' AGL/234' MSL.

**Rwy 26**, trees beginning 41' from DER, 287' left of centerline, up to 88' AGL/295' MSL.

Trees beginning 227' from DER, 30' right of centerline, up to 80' AGL/285' MSL.

## BAY MINETTE, AL

### BAY MINETTE MUNI (1R8)

#### TAKEOFF MINIMUMS AND (OBSTACLE) DEPARTURE PROCEDURES

ORIG 15MAR07 (07074) (FAA)

#### TAKEOFF OBSTACLE NOTES:

**Rwy 8**, brush 115' from DER, 80' left of centerline, 5' AGL/253' MSL.

**Rwy 26**, trees 1190' from DER, on centerline, 35' AGL/242' MSL.

Brush 135' from DER, 91' left of centerline, 5' AGL/212' MSL.

Tree 5494' from DER, 84' right of centerline, 100' AGL/348' MSL.

## BESSEMER, AL

### BESSEMER (EKY)

#### TAKEOFF MINIMUMS AND (OBSTACLE) DEPARTURE PROCEDURES

ORIG 10MAY07 (07130) (FAA)

#### TAKEOFF OBSTACLE NOTES:

**Rwy 5**, numerous trees beginning 147' from DER, 33' left of centerline, up to 100' AGL/859' MSL.

Numerous trees beginning 36' from DER, 8' right of centerline, up to 100' AGL/769' MSL.

**Rwy 23**, terrain beginning 33' from DER, 102' left of centerline, up to 709' MSL.

Tree 74' from DER, 163' right of centerline, 50' AGL/714' MSL.

Tree 175' from DER, 439' left of centerline, 11' AGL/710' MSL.

## BIRMINGHAM, AL

### BIRMINGHAM-SHUTTLESWORTH INTL (BHM)

#### TAKEOFF MINIMUMS AND (OBSTACLE) DEPARTURE PROCEDURES

AMDT 8 24MAY18 (18144) (FAA)

#### TAKEOFF MINIMUMS:

**Rwy 6**, 300-2 w/ min. climb of 285' per NM to 1800 or std. w/min. climb of 435' per NM to 1300 or 1800-3 for VCOA.

**Rwy 18**, 600-3 w/ min. climb of 225' per NM to 1300 or std. w/ min. climb of 455' per NM to 1500 or 1800-3 for VCOA.

**Rwy 24**, std. w/ min. climb of 280' per NM to 1400.

**Rwy 36**, 300-2 1/4 or std. w/min. climb of 565' per NM to 1000.

#### DEPARTURE PROCEDURE:

**Rwy 6**, climb heading 058° to 1500 before proceeding on course.

**Rwy 18**, climb heading 183° to 2300 before proceeding on course.

**Rwy 24**, climb heading 238° to 2300 before proceeding on course.

**Rwy 36**, climb heading 003° to 1400 before proceeding on course.

#### VCOA:

**Rwys 6, 18**, obtain ATC approval for VCOA when requesting IFR clearance. Climb in visual conditions to cross Birmingham-Shuttlesworth Intl at or above 2300 before proceeding on course.

#### TAKEOFF OBSTACLE NOTES:

**Rwy 6**, building 154' from DER, 401' right of centerline, 14' AGL/656' MSL.

Terrain 704' from DER, 652' left of centerline, 671' MSL.

Terrain 950' from DER, 674' right of centerline, 692' MSL.

Terrain 957' from DER, 682' left of centerline, 675' MSL.

Terrain 1226' from DER, 654' right of centerline, 713' MSL.

Terrain 1259' from DER, 705' left of centerline, 684' MSL.

Terrain beginning 1383' from DER, 391' right of centerline, up to 718' MSL.

Terrain beginning 1387' from DER, 272' left of centerline, up to 706' MSL.

Tree, terrain, traverse ways and fence beginning 1450' from DER, 33' right of centerline, up to 767' MSL.

Terrain beginning 1621' from DER, 166' left of centerline, up to 718' MSL.

Terrain beginning 1753' from DER, 5' left of centerline, up to 721' MSL.

Terrain beginning 1805' from DER, 110' left of centerline, up to 727' MSL.

Terrain and traverse way beginning 1917' from DER, 708' left of centerline, up to 730' MSL.

Terrain beginning 1993' from DER, 112' left of centerline, up to 731' MSL.

Terrain and traverse way beginning 2111' from DER, 321' left of centerline, up to 734' MSL.

Terrain beginning 2275' from DER, 111' left of centerline, up to 737' MSL.

Traverse way and terrain beginning 2346' from DER, 325' left of centerline, up to 739' MSL.

Pole, terrain and fences beginning 2449' from DER, 48' right of centerline, up to 43' AGL/769' MSL.

Terrain beginning 497' from DER, 109' left of centerline, up to 742' MSL.

Traverse way 2554' from DER, 531' left of centerline, 744' MSL.

CON'T

# TAKEOFF MINIMUMS, (OBSTACLE) DEPARTURE PROCEDURES, AND DIVERSE VECTOR AREA (RADAR VECTORS)

24025

SE-4

# TAKEOFF MINIMUMS, (OBSTACLE) DEPARTURE PROCEDURES, AND DIVERSE VECTOR AREA (RADAR VECTORS)

24025

## BIRMINGHAM, AL (CON'T)

### BIRMINGHAM-SHUTTLESWORTH INTL (BHM) (CON'T)

**Rwy 6 (CON'T)**, trees, terrain, traverse way and poles beginning 2608' from DER, 25' left of centerline, up to 779' MSL.  
 Tree, terrain and pole beginning 2846' from DER, 169' right of centerline, up to 782' MSL.  
 Tree, terrain, pole and lighting beginning 2983' from DER, 111' left of centerline, up to 800' MSL.  
 Tree and fence beginning 3007' from DER, 47' right of centerline, up to 788' MSL.  
 Trees and terrain beginning 3071' from DER, 59' right of centerline, up to 800' MSL.  
 Pole and terrain beginning 3220' from DER, 410' left of centerline, up to 44' AGL/811' MSL.  
 Tree and terrain beginning 3308' from DER, 236' right of centerline, up to 809' MSL.  
 Trees, terrain and pole beginning 3320' from DER, 96' left of centerline, up to 816' MSL.  
 Trees, terrain and fences beginning 3529' from DER, 53' right of centerline, up to 810' MSL.  
 Tree, terrain and pole beginning 3567' from DER, 154' left of centerline, up to 832' MSL.  
 Trees, terrain and pole beginning 3717' from DER, 31' left of centerline, up to 841' MSL.  
 Trees and terrain beginning 3978' from DER, 14' left of centerline, up to 865' MSL.  
 Trees and poles beginning 4099' from DER, 123' left of centerline, up to 870' MSL.  
 Trees beginning 5066' from DER, 518' left of centerline, up to 878' MSL.  
 Tree 5192' from DER, 1364' left of centerline, 883' MSL.  
 Trees beginning 5202' from DER, 973' left of centerline, up to 884' MSL.  
 Tower, trees, terrain and pole beginning 5260' from DER, 62' left of centerline, up to 97' AGL/897' MSL.  
 Trees beginning 5916' from DER, 159' right of centerline, up to 814' MSL.  
 Trees beginning 1 NM from DER, 14' right of centerline, up to 822' MSL.  
 Trees beginning 1.3 NM from DER, 1745' left of centerline, up to 901' MSL.  
 Tree 1.6 NM from DER, 2148' left of centerline, 913' MSL.  
**Rwy 18**, terrain 372' from DER, 543' right of centerline, 648' MSL.  
 Terrain beginning 536' from DER, 453' right of centerline, up to 672' MSL.  
 Poles, traverse ways and trees beginning 771' from DER, 58' left of centerline, up to 71' AGL/701' MSL.  
 Trees and pole beginning 1084' from DER, 125' right of centerline, up to 686' MSL.  
 Trees beginning 1220' from DER, 96' right of centerline, up to 690' MSL.  
 Trees beginning 1330' from DER, 209' right of centerline, up to 695' MSL.  
 Trees and poles beginning 1367' from DER, on centerline, up to 704' MSL.  
 Trees and pole beginning 1640' from DER, 34' left of centerline, up to 704' MSL.  
 Trees and pole beginning 1674' from DER, 16' left of centerline, up to 709' MSL.  
 Trees and poles beginning 1767' from DER, 14' left of centerline, up to 80' AGL/717' MSL.  
 Trees, sign and pole beginning 2148' from DER, 218' left of centerline, up to 724' MSL.  
 Tower and trees beginning 2546' from DER, 44' left of centerline, up to 99' AGL/749' MSL.  
 Tree 2813' from DER, 167' right of centerline, 724' MSL.  
 Trees beginning 2824' from DER, 199' right of centerline, up to 730' MSL.  
 Trees beginning 2958' from DER, 39' right of centerline, up to 732' MSL.  
 Spire 4511' from DER, 1449' right of centerline, 126' AGL/753' MSL.  
 Transmission lines and trees beginning 4715' from DER, 1068' left of centerline, up to 102' AGL/802' MSL.  
 Trees beginning 4969' from DER, 1024' left of centerline, up to 803' MSL.  
 Trees beginning 5057' from DER, 1185' left of centerline, up to 809' MSL.  
 Trees and transmission line, pole beginning 5168' from DER, 221' left of centerline, up to 813' MSL.  
 Antenna 5409' from DER, 1145' right of centerline, 110' AGL/774' MSL.  
 Trees beginning 5581' from DER, 454' left of centerline, up to 819' MSL.  
 Tree 5591' from DER, 48' right of centerline, 781' MSL.  
 Trees and transmission line beginning 5680' from DER, 254' left of centerline, up to 837' MSL.  
 Tree 5757' from DER, 562' right of centerline, 782' MSL.  
 Trees, building and transmission line beginning 5812' from DER, 58' left of centerline, up to 838' MSL.  
 Tree 5993' from DER, 17' right of centerline, 787' MSL.  
 Trees and transmission lines beginning 5997' from DER, 299' left of centerline, up to 842' MSL.  
 Trees and poles beginning 1 NM from DER, 819' left of centerline, up to 844' MSL.  
 Transmission line 1.1 NM from DER, 2018' left of centerline, 129' AGL/891' MSL.  
 Poles, trees and transmission line beginning 1.1 NM from DER, 321' left of centerline, up to 126' AGL/893' MSL.  
 Trees beginning 1.2 NM from DER, 703' left of centerline, up to 897' MSL.  
 Tree 1.2 nm from DER, 560' right of centerline, 826' MSL.  
 Trees beginning 1.2 NM from DER, 118' left of centerline, up to 906' MSL.  
 Trees beginning 1.2 NM from DER, 220' right of centerline, up to 843' MSL.  
 Trees beginning 1.3 NM from DER, 60' right of centerline, up to 864' MSL.  
 Trees and pole beginning 1.3 NM from DER, 94' left of centerline, up to 971' MSL.  
 Trees, Building, and pole beginning 1.4 NM from DER, 800' left of centerline, up to 1041' MSL.  
 Trees, poles, transmission line, tank and water tower beginning 1.5 NM from DER, 426' left of centerline, up to 1139' MSL.  
 Tower, antenna, trees, pole and buildings beginning 1.7 NM from DER, 1' left of centerline, up to 150' AGL/1219' MSL.  
 Tree 1.7 NM from DER, 203' right of centerline, 925' MSL.  
 Trees beginning 1.8 NM from DER, 94' right of centerline, up to 1017' MSL.  
 Buildings and trees beginning 1.9 NM from DER, 3' right of centerline, up to 1106' MSL.  
 Tree 2 NM from DER, 1019' right of centerline, 1120' MSL.  
 Trees beginning 2 NM from DER, 127' right of centerline, up to 1134' MSL.  
 Trees, pole, buildings and towers beginning 2.1 NM from DER, 423' right of centerline, up to 1167' MSL.  
 Towers, trees, water tower, antenna and building beginning 2.2 NM from DER, 807' right of centerline, up to 114' AGL/1172' MSL.  
**Rwy 24**, lighting 7' from DER, 5' right of centerline, 1' AGL/604' MSL.  
 Lighting 7' from DER, 5' left of centerline, 2' AGL/604' MSL.  
 Tree 991' from DER, 561' left of centerline, 642' MSL.  
 Trees beginning 1057' from DER, 648' left of centerline, up to 663' MSL.

CON'T

22 FEB 2024 to 21 MAR 2024

22 FEB 2024 to 21 MAR 2024

# TAKEOFF MINIMUMS, (OBSTACLE) DEPARTURE PROCEDURES, AND DIVERSE VECTOR AREA (RADAR VECTORS)

24025

SE-4

# TAKEOFF MINIMUMS, (OBSTACLE) DEPARTURE PROCEDURES, AND DIVERSE VECTOR AREA (RADAR VECTORS)

24025

## BIRMINGHAM, AL (CON'T)

### BIRMINGHAM-SHUTTLESWORTH INTL (BHM) (CON'T)

**Rwy 24 (CON'T)**, tree and sign beginning 1610' from DER, 757' left of centerline, up to 673' MSL.

Tree 2636' from DER, 1172' left of centerline, 690' MSL.

**Rwy 36**, traverse way, fences, terrain and tree beginning 159' from DER, 505' right of centerline, up to 16' AGL/661' MSL.

Terrain 192' from DER, 493' left of centerline, 653' MSL.

Tree 326' from DER, 528' left of centerline, 682' MSL.

Trees, terrain, poles, fences and vegetation beginning 467' from DER, 2' right of centerline, up to 726' MSL.

Tree 576' from DER, 532' left of centerline, 696' MSL.

Trees and terrain beginning 792' from DER, 215' left of centerline, up to 728' MSL.

Trees and terrain beginning 986' from DER, 122' left of centerline, up to 729' MSL.

Trees beginning 1332' from DER, 106' left of centerline, up to 745' MSL.

Trees, pole and traverse way beginning 1378' from DER, 188' left of centerline, up to 750' MSL.

Trees and terrain beginning 1632' from DER, 82' left of centerline, up to 768' MSL.

Tree, terrain and vegetation beginning 1921' from DER, 76' right of centerline, up to 738' MSL.

Terrain beginning 2189' from DER, 433' right of centerline, up to 753' MSL.

Trees and terrain beginning 2331' from DER, 38' right of centerline, up to 785' MSL.

Terrain and tree beginning 2444' from DER, 17' left of centerline, up to 772' MSL.

Terrain beginning 2714' from DER, 356' left of centerline, up to 775' MSL.

Trees, vegetation, terrain and poles beginning 2816' from DER, on centerline, up to 839' MSL.

Trees, terrain and poles beginning 2877' from DER, 3' left of centerline, up to 846' MSL.

Trees and terrain beginning 3808' from DER, 44' right of centerline, up to 870' MSL.

Trees, terrain and pole beginning 4114' from DER, 20' right of centerline, up to 872' MSL.

Trees beginning 4345' from DER, 864' right of centerline, up to 105' AGL/875' MSL.

Trees, terrain, building and poles beginning 4427' from DER, on centerline, up to 879' MSL.

Trees and traverse way beginning 5381' from DER, 183' left of centerline, up to 852' MSL.

Tree 5435' from DER, 1013' left of centerline, 861' MSL.

Tree and poles beginning 5465' from DER, 44' left of centerline, up to 864' MSL.

Trees, poles and traverse way beginning 5529' from DER, 85' left of centerline, up to 870' MSL.

Trees beginning 5653' from DER, 320' left of centerline, up to 874' MSL.

Trees, vegetation, pole, traverse way and building beginning 5707' from DER, 143' left of centerline, up to 879' MSL.

Trees and traverse way beginning 5913' from DER, 175' left of centerline, up to 887' MSL.

Trees, tower, traverse way, pole, terrain and building beginning 1 nm from DER, 32' left of centerline, up to 908' MSL.

Trees and poles beginning 1.1 NM from DER, 1193' right of centerline, up to 907' MSL.

Tree 1.7 NM from DER, 262' left of centerline, 109' AGL/919' MSL.

## BLAIRSVILLE, GA

### BLAIRSVILLE (DZJ)

#### TAKEOFF MINIMUMS AND (OBSTACLE) DEPARTURE PROCEDURES

AMDT 1 20APR23 (23110) (FAA)

##### TAKEOFF MINIMUMS:

**Rwys 8, 26**, 2900-3 for VCOA.

VCOA:

**Rwys 8, 26**, obtain ATC approval for VCOA when requesting IFR clearance. Climb in visual conditions to cross Blairsville airport at or above 4700 before proceeding on course.

##### TAKEOFF OBSTACLE NOTES:

**Rwy 8**, terrain 74' from DER, 436' right of centerline, 1858' MSL.

Trees, terrain, fence beginning 81' from DER, 150' right of centerline, up to 1909' MSL.

Trees, terrain, poles, vegetation, fence, vehicles on roads, buildings, smokestack beginning 113' from DER, 75' left of centerline, up to 1930' MSL.

Trees, terrain beginning 229' from DER, 150' right of centerline, up to 1930' MSL.

Trees, terrain, vegetation beginning 494' from DER, 139' right of centerline, up to 1934' MSL.

Trees, terrain, vegetation beginning 1112' from DER, 236' right of centerline, up to 1979' MSL.

Trees, terrain, poles, buildings, fences, vehicles on roads, utility buildings beginning 1234' from DER, 1' right of centerline, up to 1995' MSL.

Trees, terrain, poles, buildings beginning 2015' from DER, 119' left of centerline, up to 1985' MSL.

Trees, vehicles on road, buildings, terrain beginning 2218' from DER, 4' left of centerline, up to 1998' MSL.

Trees, pole, buildings beginning 2406' from DER, 12' left of centerline, up to 2003' MSL.

Trees beginning 2529' from DER, 45' left of centerline, up to 2006' MSL.

Trees, pole beginning 2914' from DER, 7' left of centerline, up to 2016' MSL.

Trees beginning 3148' from DER, 544' left of centerline, up to 2030' MSL.

Trees, pole beginning 3193' from DER, 219' left of centerline, up to 2036' MSL.

Trees, buildings, terrain beginning 3252' from DER, 13' left of centerline, up to 2039' MSL.

Trees beginning 5691' from DER, 1786' left of centerline, up to 2043' MSL.

Trees beginning 1.2 NM from DER, 38' left of centerline, up to 2099' MSL.

Trees beginning 1.2 NM from DER, 68' right of centerline, up to 2079' MSL.

Trees beginning 1.3 NM from DER, 23' left of centerline, up to 2118' MSL.

Trees beginning 1.3 NM from DER, 26' right of centerline, up to 2095' MSL.

Trees beginning 1.4 NM from DER, 209' right of centerline, up to 2140' MSL.

Trees beginning 1.4 NM from DER, 2' left of centerline, up to 2141' MSL.

Trees beginning 1.5 NM from DER, 99' left of centerline, up to 2314' MSL.

Trees, terrain, vehicles on roads, vegetation, buildings, pole beginning 1.5 NM from DER, 25' right of centerline, up to 2245' MSL.

CON'T

# TAKEOFF MINIMUMS, (OBSTACLE) DEPARTURE PROCEDURES, AND DIVERSE VECTOR AREA (RADAR VECTORS)

24025

SE-4

# TAKEOFF MINIMUMS, (OBSTACLE) DEPARTURE PROCEDURES, AND DIVERSE VECTOR AREA (RADAR VECTORS)

24025

## BLAIRSVILLE, GA (CON'T)

### BLAIRSVILLE (DZJ) (CON'T)

**Rwy 8 (CON'T)**, trees, pole beginning 1.6 NM from DER, 29' left of centerline, up to 2395' MSL.

Trees, pole beginning 1.7 NM from DER, 8' right of centerline, up to 2348' MSL.

Antennas, tower, trees beginning 1.7 NM from DER, 31' left of centerline, up to 2563' MSL.

Trees beginning 2.5 NM from DER, 1508' right of centerline, 2445' MSL.

**Rwy 26**, vegetation 10' from DER, 180' right of centerline, 1912' MSL.

Trees, pole beginning 14' from DER, 245' left of centerline, up to 80' AGL/1999' MSL.

Trees 196' from DER, 297' right of centerline, 1913' MSL.

Trees, pole beginning 218' from DER, 219' left of centerline, up to 2012' MSL.

Building 231' from DER, 392' right of centerline, 1928' MSL.

Trees, building, pole beginning 267' from DER, 132' left of centerline, up to 2014' MSL.

Trees, buildings beginning 294' from DER, 302' right of centerline, up to 1951' MSL.

Trees, vegetation, buildings, poles, terrain beginning 400' from DER, 138' left of centerline, up to 2022' MSL.

Trees, building beginning 421' from DER, 304' right of centerline, up to 2015' MSL.

Trees, terrain, fence, buildings, vegetation, vehicles on roads beginning 588' from DER, 10' right of centerline, up to 2034' MSL.

Tree, terrain beginning 761' from DER, 171' left of centerline, up to 2029' MSL.

Trees, vegetation, terrain, building, poles, fence, vehicles on roads beginning 773' from DER, 1' left of centerline, up to 2039' MSL.

Trees, terrain, pole, vehicles on road beginning 1517' from DER, 18' right of centerline, up to 2068' MSL.

Trees beginning 1666' from DER, 447' right of centerline, up to 2070' MSL.

Tree, vegetation beginning 1682' from DER, 58' right of centerline, up to 2072' MSL.

Trees, terrain, poles, vehicles on roads, vegetation, buildings beginning 1691' from DER, 4' right of centerline, up to 2077' MSL.

Trees beginning 2801' from DER, 50' left of centerline, up to 2044' MSL.

Trees, pole, buildings beginning 2894' from DER, 6' left of centerline, up to 2062' MSL.

Trees beginning 3477' from DER, 16' left of centerline, up to 2066' MSL.

Trees beginning 4327' from DER, 166' left of centerline, up to 2094' MSL.

Trees, building beginning 4396' from DER, 50' right of centerline, up to 2108' MSL.

Trees beginning 4648' from DER, 46' left of centerline, up to 2017' MSL.

Trees beginning 4753' from DER, 305' right of centerline, up to 2018' MSL.

Trees beginning 4902' from DER, 10' right of centerline, up to 2120' MSL.

Trees beginning 5160' from DER, 28' right of centerline, up to 2124' MSL.

Tree 1.3 NM from DER, 926' right of centerline, 2126' MSL.

Trees beginning 1.4 NM from DER, 682' right of centerline, up to 2142' MSL.

Trees beginning 1.5 NM from DER, 1026' right of centerline, up to 2179' MSL.

Trees beginning 1.6 NM from DER, 764' right of centerline, up to 2211' MSL.

Tree 1.9 NM from DER, 3558' left of centerline, 2210' MSL.

Tree 2.1 NM from DER, 2717' left of centerline, 2275' MSL.

Tree 2.2 NM from DER, 3020' right of centerline, 2286' MSL.

Trees, building beginning 2.2 NM from DER, 2620' left of centerline, up to 2466' MSL.

Trees, building beginning 2.3 NM from DER, 2473' right of centerline, up to 2367' MSL.

Trees beginning 2.4 NM from DER, 3002' right of centerline, up to 2404' MSL.

Tree 2.5 NM from DER, 3049' right of centerline, 2357' MSL.

## BLAKELY, GA

### EARLY COUNTY (BIJ)

#### TAKEOFF MINIMUMS AND (OBSTACLE) DEPARTURE PROCEDURES

ORIG 14FEB08 (08045) (FAA)

#### TAKEOFF OBSTACLE NOTES:

**Rwy 5**, trees beginning 12' from DER, 214' left of centerline, up to 100' AGL/319' MSL.

Trees beginning 17' from DER, 122' right of centerline, up to 100' AGL/329' MSL.

Vehicles on roadway, beginning 416' from DER, left and right of centerline, up to 17' AGL/236' MSL.

Trains on railroad tracks beginning 883' from DER, 684' left of centerline, up to 23' AGL/242' MSL.

**Rwy 23**, trees beginning at DER, 2924' right of centerline, up to 100' AGL/319' MSL.

Trees beginning 417' from DER, left and right of centerline, up to 100' AGL/319' MSL.

Vehicles on roadway, 537' from DER, 628' right of centerline, up to 17' AGL/236' MSL.

Buildings 1418' from DER, 203' left of centerline, up to 50' AGL/269' MSL.

## BREWTON, AL

### BREWTON MUNI (12J)

#### TAKEOFF MINIMUMS AND (OBSTACLE) DEPARTURE PROCEDURES

AMDT 2 11MAR10 (10070) (FAA)

#### TAKEOFF MINIMUMS:

**Rwys 18, 36**, NA-Closed Indef.

#### TAKEOFF OBSTACLE NOTES:

**Rwy 6**, trees 141' from DER, 33' left of centerline, 25' AGL/121' MSL.

**Rwy 12**, trees 199' from DER, 495' right of centerline, 57' AGL/156' MSL.

Vehicle on road, 1906' from DER, 456' right of centerline, 15' AGL/156' MSL.

**Rwy 24**, trees 380' from DER, 135' left of centerline, 25' AGL, 127' MSL.

**Rwy 30**, trees 92' from DER, 391' right of centerline, 46' AGL/126' MSL.

Trees, 2654' from DER, 1129' left of centerline, 91' AGL/161' MSL.

# TAKEOFF MINIMUMS, (OBSTACLE) DEPARTURE PROCEDURES, AND DIVERSE VECTOR AREA (RADAR VECTORS)

24025

**TAKEOFF MINIMUMS, (OBSTACLE) DEPARTURE PROCEDURES, AND**

  
**DIVERSE VECTOR AREA (RADAR VECTORS)**

24025

**BRUNSWICK, GA****BRUNSWICK GOLDEN ISLES (BQK)**

## TAKEOFF MINIMUMS AND (OBSTACLE) DEPARTURE PROCEDURES

ORIG 03AUG06 (06215) (FAA)

## TAKEOFF OBSTACLE NOTES:

**Rwy 7**, tree 1380' from DER, 840' right of centerline, 38' AGL/57' MSL.**Rwy 25**, multiple trees beginning 1259' from DER, 688' right of centerline, up to 50' AGL/74' MSL.**BUTLER, AL****BUTLER/CHOCTAW COUNTY (09A)**

## TAKEOFF MINIMUMS AND (OBSTACLE) DEPARTURE PROCEDURES

AMDT 2 08SEP22 (22251) (FAA)

## TAKEOFF MINIMUMS:

**Rwy 30**, 300-1% or std. w/min. climb of 260' per NM to 400.

## TAKEOFF OBSTACLE NOTES:

**Rwy 12**, trees, poles abeam the DER, 1' left of centerline, up to 208' MSL.

Poles beginning 349' from DER, 492' right of centerline, up to 24' AGL/144' MSL.

Poles beginning 471' from DER, 410' right of centerline, up to 29' AGL/151' MSL.

Trees beginning 768' from DER, 127' right of centerline, up to 155' MSL.

Trees beginning 880' from DER, 63' right of centerline, up to 163' MSL.

Trees beginning 1072' from DER, 518' right of centerline, up to 187' MSL.

Trees beginning 1288' from DER, 92' right of centerline, up to 192' MSL.

Trees beginning 1475' from DER, 28' right of centerline, up to 193' MSL.

Trees beginning 1547' from DER, 515' right of centerline, up to 201' MSL.

Trees beginning 2006' from DER, 859' right of centerline, up to 202' MSL.

**Rwy 30**, trees beginning 93' from DER, 287' right of centerline, up to 195' MSL.

Trees beginning 100' from DER, 248' left of centerline, up to 168' MSL.

Trees beginning 246' from DER, 297' right of centerline, up to 196' MSL.

Trees beginning 372' from DER, 179' left of centerline, up to 178' MSL.

Trees beginning 622' from DER, 231' left of centerline, up to 190' MSL.

Trees beginning 796' from DER, 278' left of centerline, up to 213' MSL.

Trees beginning 1046' from DER, 107' left of centerline, up to 220' MSL.

Trees beginning 1461' from DER, 8' right of centerline, up to 210' MSL.

Trees beginning 1946' from DER, 147' left of centerline, up to 222' MSL.

Tree 2516' from DER, 738' right of centerline, 212' MSL.

Trees beginning 2522' from DER, 501' right of centerline, up to 215' MSL.

Trees beginning 2751' from DER, 147' right of centerline, up to 230' MSL.

Trees beginning 3313' from DER, 317' right of centerline, up to 232' MSL.

Trees beginning 3341' from DER, 290' left of centerline, up to 228' MSL.

Trees beginning 3579' from DER, 289' right of centerline, up to 236' MSL.

Tree 5170' from DER, 1626' right of centerline, 249' MSL.

Trees beginning 5337' from DER, 1327' right of centerline, up to 279' MSL.

Trees beginning 5482' from DER, 1172' right of centerline, up to 280' MSL.

Trees beginning 5641' from DER, 154' right of centerline, up to 298' MSL.

Trees beginning 6072' from DER, 716' right of centerline, up to 306' MSL.

Trees beginning 6072' from DER, 716' right of centerline, up to 306' MSL.

Trees beginning 1 NM from DER, 2025' right of centerline, up to 292' MSL.

**BUTLER, GA****BUTLER MUNI (6A1)**

## TAKEOFF MINIMUMS AND (OBSTACLE) DEPARTURE PROCEDURES

AMDT 1A 28FEB19 (19059) (FAA)

## TAKEOFF MINIMUMS:

**Rwys 6, 24**, NA - Environmental.

## TAKEOFF OBSTACLE NOTES:

**Rwy 1**, trees beginning 196' from DER, 483' left of centerline, up to 651' MSL.**Rwy 19**, tree, lighting, pole beginning 64' from DER, 29' left of centerline, up to 734' MSL.

Vegetation beginning 86' from DER, 234' right of centerline, up to 665' MSL.

Tree 638' from DER, 524' right of centerline, 699' MSL.

Trees beginning 705' from DER, 21' right of centerline, up to 704' MSL.

Trees beginning 857' from DER, 311' right of centerline, up to 709' MSL.

Trees beginning 963' from DER, 348' right of centerline, up to 726' MSL.

Trees beginning 1070' from DER, 70' right of centerline, up to 727' MSL.

22 FEB 2024 to 21 MAR 2024

22 FEB 2024 to 21 MAR 2024

**TAKEOFF MINIMUMS, (OBSTACLE) DEPARTURE PROCEDURES, AND**

  
**DIVERSE VECTOR AREA (RADAR VECTORS)**

24025

SE-4

# TAKEOFF MINIMUMS, (OBSTACLE) DEPARTURE PROCEDURES, AND DIVERSE VECTOR AREA (RADAR VECTORS)

24025

## CAIRNS AAF (KOZR)

FORT NOVOSEL, AL

TAKEOFF MINIMUMS AND (OBSTACLE) DEPARTURE PROCEDURES

AMDT 1 13JUL23 (23194) (USA)

TAKEOFF MINIMUMS:

**Rwys 6, 24, 18, 36, and Helipads C, G, A, D1, D2**, std. All other helipads, NA.

DEPARTURE PROCEDURE:

**Helipad C**, climb heading 178° to 1000 before proceeding on course.**Helipad G**, climb heading 178° to 1000 before proceeding on course.

TAKEOFF OBSTACLE NOTES:

**Rwy 6**, twr 4701' from DER, 1754' left of centerline, 160' AGL/433' MSL.

Trees 454' from DER, 385' left of centerline, 100' AGL/332' MSL.

Trees 458' from DER, 268' right of centerline, 100' AGL/318' MSL.

Trees 808' from DER, 254' right of centerline, 100' AGL/331' MSL.

Trees 939' from DER, 145' right of centerline, 100' AGL/320' MSL.

**Rwy 24**, trees 1231' from DER, 618' right of centerline, 100' AGL/356' MSL.**Rwy 18**, trees 525' from DER, 578' left of centerline, 75' AGL/364' MSL.**Rwy 36**, trees 1654' from DER, 54' right of centerline, 100' AGL/370' MSL.

Trees 1919' from DER, 65' right of centerline, 100' AGL/372' MSL.

Trees 1960' from DER, 413' left of centerline, 100' AGL/376' MSL.

Tree 835' from DER, 368' right of centerline, 100' AGL/356' MSL.

**Helipad A**, RADAR antenna, 859' from DER, 547' left of centerline, 103' AGL/409' MSL.

Terrain at DER, 500' right of centerline, 308' MSL.

Tree 772' from DER, 143' right of centerline, 363' MSL.

Tree 818' from DER, 440' right of centerline, 370' MSL.

**Helipad C**, twr 2323' from DER, 1084' right of centerline, 72' AGL/375' MSL.

Terrain at DER, 156' right of centerline, 315' MSL.

**Helipad D1**, terrain 71' from DER, 429' right of centerline, 318' MSL.

Tree 1009' from DER, 404' left of centerline, 361' MSL.

Tree 1378' from DER, 476' right of centerline, 380' MSL.

Tree 788' from DER, 54' left of centerline, 370' MSL.

Tree 857' from DER, 592' left of centerline, 375' MSL.

Tree 904' from DER, 169' right of centerline, 370' MSL.

**Helipad D2**, terrain at DER, 238' left of centerline, 312' MSL.

Terrain 86' from DER, 64' right of centerline, 315' MSL.

Tree 1005' from DER, 410' left of centerline, 370' MSL.

Tree 1121' from DER, 187' left of centerline, 370' MSL.

Tree 1225' from DER, 759' left of centerline, 361' MSL.

Tree 1566' from DER, 768' right of centerline, 376' MSL.

Tree 1594' from DER, 120' right of centerline, 380' MSL.

DIVERSE VECTOR AREA (RADAR VECTORS)

ORIG 13JUL23 (23194) (USA)

All **Rwys**, heading as assigned by ATC.

## CAIRO, GA

CAIRO-GRADY COUNTY (70J)

TAKEOFF MINIMUMS AND (OBSTACLE) DEPARTURE PROCEDURES

AMDT 3 23SEP10 (10266) (FAA)

TAKEOFF OBSTACLE NOTES:

**Rwy 13**, trees beginning 36' from DER, 240' left of centerline, up to 35' AGL/259' MSL.

Trees beginning 203' from DER, 37' right of centerline, up to 35' AGL/273' MSL.

Trees beginning 1037' from DER, 67' right of centerline, up to 35' AGL/285' MSL.

Trees beginning 1295' from DER, 1' left of centerline, up to 35' AGL/275' MSL.

**Rwy 31**, truck 120' from DER, 217' left of centerline, 15' AGL/274' MSL.

Trees beginning 277' from DER, 355' right of centerline, up to 35' AGL/306' MSL.

Trees beginning 1188' from DER, 4' right of centerline, up to 35' AGL/335' MSL.

Trees beginning 1777' from DER, 74' left of centerline, up to 35' AGL/334' MSL.

# TAKEOFF MINIMUMS, (OBSTACLE) DEPARTURE PROCEDURES, AND DIVERSE VECTOR AREA (RADAR VECTORS)

24025



# TAKEOFF MINIMUMS, (OBSTACLE) DEPARTURE PROCEDURES, AND DIVERSE VECTOR AREA (RADAR VECTORS)

24025

## CALHOUN, GA

### TOM B DAVID FLD (CZL)

#### TAKEOFF MINIMUMS AND (OBSTACLE) DEPARTURE PROCEDURES

AMDT 3 12DEC13 (22083) (FAA)

##### TAKEOFF MINIMUMS:

**Rwy 17**, min. climb of 230' per NM to 1600, or 1200-3 for climb in visual conditions.

**Rwy 35**, 400-2½ or std. w/min. climb of 220' per NM to 1100 or alternatively, with std. takeoff minimums and a normal 200' per NM climb gradient, takeoff must occur no later than 1900' prior to DER.

##### DEPARTURE PROCEDURE:

**Rwy 17**, climb heading 173° to 1200 before proceeding on course. For climb in visual conditions, cross Tom B David Fld at or above 1700 before proceeding on course. When executing VCOA, notify ATC prior to departure.

**Rwy 35**, climb heading 353° to 1700 before turning left.

##### TAKEOFF OBSTACLE NOTES:

**Rwy 17**, trees, poles, and buildings beginning 245' from DER, left and right of centerline, up to 75' AGL/725' MSL.

Trees and poles beginning 1663' from DER, left and right of centerline, up to 139' AGL/779' MSL.

Trees beginning 1 NM from DER, 916' left of centerline, up to 119' AGL/879' MSL.

**Rwy 35**, trees and bushes beginning 75' from DER, left and right of centerline, up to 100' AGL/730' MSL.

Trees and poles beginning 1948' from DER, left and right of centerline, up to 108' AGL/738' MSL.

Trees beginning 1.9 NM from DER, 298' right of centerline, up to 105' AGL/957' MSL.

## CAMDEN, AL

### CAMDEN MUNI (61A)

#### TAKEOFF MINIMUMS AND (OBSTACLE) DEPARTURE PROCEDURES

ORIG 05JAN17 (17005) (FAA)

##### TAKEOFF OBSTACLE NOTES:

**Rwy 18**, trees, beginning 3' from DER, 204' left of centerline, up to 200' MSL.

Trees, beginning 83' from DER, 418' left of centerline, up to 225' MSL.

Tree, terrain, beginning 132' from DER, 48' right of centerline, up to 230' MSL.

Tree, terrain, beginning 335' from DER, 52' right of centerline, up to 233' MSL.

Tree 546' from DER, 279' left of centerline, 242' MSL.

Tree, terrain, beginning 547' from DER, 35' left of centerline, up to 260' MSL.

**Rwy 36**, tree, terrain, beginning 51' from DER, 188' left of centerline, up to 191' MSL.

Tree 149' from DER, 252' right of centerline, 231' MSL.

Tree, terrain, pole, beginning 166' from DER, 18' right of centerline, up to 239' MSL.

Trees, beginning 416' from DER, 516' left of centerline, up to 212' MSL.

Tree, pole, ant, bush, beginning 444' from DER, 98' left of centerline, up to 219' MSL.

## CAMILLA, GA

### CAMILLA-MITCHELL COUNTY (CXU)

#### TAKEOFF MINIMUMS AND (OBSTACLE) DEPARTURE PROCEDURES

AMDT 2 09JAN14 (14009) (FAA)

##### DEPARTURE PROCEDURE:

**Rwy 8**, climb heading 084° to 1100 before turning right.

##### TAKEOFF OBSTACLE NOTES:

**Rwy 8**, tree 127' from DER, 348' right of centerline, 15' AGL/185' MSL.

Trees beginning 223' from DER, 499' left of centerline, up to 75' AGL/241' MSL.

Trees beginning 892' from DER, 514' right of centerline, up to 75' AGL/249' MSL.

Trees beginning 1511' from DER, 9' left of centerline, up to 80' AGL/267' MSL.

Trees beginning 1529' from DER, 94' right centerline, up to 80' AGL/269' MSL.

**Rwy 26**, trees beginning 27' from DER, 409' left of centerline, up to 45' AGL/234' MSL.

Tree 29' from DER, 312' right of centerline, 35' AGL/205' MSL.

Tree 40' from DER, 125' left of centerline, 8' AGL/171' MSL.

Trees beginning 940' from DER, 733' left of centerline, up to 75' AGL/229' MSL.

Trees beginning 1696' from DER, 1696' right of centerline, up to 80' AGL/225' MSL.

## CANON, GA

### FRANKLIN-HART (18A)

#### TAKEOFF MINIMUMS AND (OBSTACLE) DEPARTURE PROCEDURES

ORIG 25SEP08 (21168) (FAA)

##### TAKEOFF MINIMUMS:

**Rwy 8**, 400-2¼ or std. w/min. climb of 217' per NM to 1400. Alternatively, with std. takeoff minimums and a normal 200'/NM climb gradient, takeoff must occur no later than 1800' prior to DER.

##### TAKEOFF OBSTACLE NOTES:

**Rwy 8**, trees beginning 142' from DER, 9' right of centerline, up to 110' AGL/1006' MSL.

Trees beginning 469' from DER, 43' left of centerline, up to 114' AGL/1004' MSL.

**Rwy 26**, trees beginning 134' from DER, 301' right of centerline, up to 57' AGL/885' MSL.

Trees beginning 514' from DER, 26' left of centerline, up to 73' AGL/902' MSL.

# TAKEOFF MINIMUMS, (OBSTACLE) DEPARTURE PROCEDURES, AND DIVERSE VECTOR AREA (RADAR VECTORS)

24025

SE-4

# TAKEOFF MINIMUMS, (OBSTACLE) DEPARTURE PROCEDURES, AND DIVERSE VECTOR AREA (RADAR VECTORS)

24025

## CANTON, GA

CHEROKEE COUNTY RGNL (CNI)

TAKEOFF MINIMUMS AND (OBSTACLE) DEPARTURE PROCEDURES

AMDT 2A 16JUL20 (20198) (FAA)

TAKEOFF MINIMUMS:

**Rwy 5**, std. w/min. climb of 300' per NM to 4500, or 1600-3 for VCOA.

**Rwy 23**, 300-1 or std. w/min. climb of 236' per NM to 1500, or alternatively, with std. takeoff minimums and a normal 200' per NM climb gradient, takeoff must occur no later than 1800' prior to DER.

DEPARTURE PROCEDURE:

**Rwy 23**, climb on heading 227° to 2500 before proceeding on course.

VCOA:

**Rwy 5**, obtain ATC approval for VCOA when requesting IFR clearance. Climb in visual conditions to cross Cherokee County RGNL airport at or above 2700 before proceeding on course.

TAKEOFF OBSTACLE NOTES:

**Rwy 5**, lighting 10' from DER, 17' right of centerline, 2' AGL/1190' MSL.

Trees beginning 25' from DER, 149' left of centerline, up to 1200' MSL.

Tree 65' from DER, 466' left of centerline, 1213' MSL.

Tree 121' from DER, 489' left of centerline, 1220' MSL.

Trees beginning 152' from DER, 142' left of centerline, up to 1226' MSL.

Trees beginning 506' from DER, 446' left of centerline, up to 1233' MSL.

Tree 3578' from DER, 157' right of centerline, 1282' MSL.

Trees beginning 3590' from DER, 250' right of centerline, up to 1286' MSL.

Transmission line 4866' from DER, 1062' right of centerline, 140' AGL/1327' MSL.

**Rwy 23**, vegetation 28' from DER, 496' right of centerline, 1207' MSL.

Tree, transmission line, pole beginning 56' from DER, 357' left of centerline, up to 1245' MSL.

Tree 165' from DER, 335' right of centerline, 1248' MSL.

## CARROLLTON, GA

WEST GEORGIA RGNL - O V GRAY FLD (CTJ)

TAKEOFF MINIMUMS AND (OBSTACLE) DEPARTURE PROCEDURES

ORIG 07MAY09 (21168) (FAA)

TAKEOFF MINIMUMS:

**Rwy 35**, 300-1 or std. w/min. climb of 276' per NM to 1400.

DEPARTURE PROCEDURE:

**Rwy 35**, climb heading 348° to 1800 before turning east.

TAKEOFF OBSTACLE NOTES:

**Rwy 17**, trees beginning 261' from DER, 433' right of centerline, up to 100' AGL/1219' MSL.

Trees beginning 301' from DER, 449' left of centerline, up to 100' AGL/1199' MSL.

**Rwy 35**, trees beginning 123' from DER, 3' left of centerline, up to 100' AGL/1283' MSL.

Trees beginning 1189' from DER, 127' right of centerline, up to 100' AGL/1283' MSL.

Vehicle on road 2489' from DER, 477' left of centerline, 17' AGL/1235' MSL.

## CARTERSVILLE, GA

CARTERSVILLE (VPC)

TAKEOFF MINIMUMS AND (OBSTACLE) DEPARTURE PROCEDURES

AMDT 1 25OCT07 (07298) (FAA)

TAKEOFF MINIMUMS:

**Rwy 1**, 500-2½ or std. w/ min. climb of 361' per NM to 1300.

**Rwy 19**, 400-2½ or std. w/ min. climb of 600' per NM to 1300.

DEPARTURE PROCEDURE:

**Rwy 1**, climb heading 007° to 2300 before proceeding on course.

**Rwy 19**, climb heading 187° to 1300 before turning westbound.

TAKEOFF OBSTACLE NOTES:

**Rwy 1**, trees beginning 24' from DER, 236' left of centerline, up to 74' AGL/798' MSL.

Brush 199' from DER, 160' right of centerline, 26' AGL/756' MSL.

Tree 1253' from DER, 641' right of centerline, 69' AGL/808' MSL.

Trees beginning 8789' from DER, 2511' right of centerline, up to 100' AGL/1199' MSL.

**Rwy 19**, terrain 194' from DER, 466' left of centerline, 0' AGL/775' MSL.

Trees beginning 2357' from DER, 44' left of centerline, up to 80' AGL/1079' MSL.

Trees beginning 2312' from DER, 119' right of centerline, up to 80' AGL/1019' MSL.

22 FEB 2024 to 21 MAR 2024

22 FEB 2024 to 21 MAR 2024

# TAKEOFF MINIMUMS, (OBSTACLE) DEPARTURE PROCEDURES, AND DIVERSE VECTOR AREA (RADAR VECTORS)

24025

SE-4

# TAKEOFF MINIMUMS, (OBSTACLE) DEPARTURE PROCEDURES, AND DIVERSE VECTOR AREA (RADAR VECTORS)

24025

## CEDARTOWN, GA

### POLK COUNTY/CORNELIUS MOORE FLD (4A4)

TAKEOFF MINIMUMS AND (OBSTACLE) DEPARTURE PROCEDURES  
AMDT 2 22APR21 (21112) (FAA)

TAKEOFF OBSTACLE NOTES:

**Rwy 10**, tree 2' from DER, 370' left of centerline, 999' MSL.  
Trees beginning 9' from DER, 273' left of centerline, up to 1009' MSL.  
Trees beginning 48' from DER, 31' right of centerline, up to 1006' MSL.  
Trees beginning 2218' from DER, 918' right of centerline, up to 1008' MSL.  
**Rwy 28**, trees beginning 18' from DER, 146' left of centerline, up to 991' MSL.  
Trees beginning 70' from DER, 282' right of centerline, up to 1012' MSL.  
Trees, transmission line beginning 116' from DER, 249' right of centerline, up to 1018' MSL.  
Trees beginning 333' from DER, 488' left of centerline, up to 1014' MSL.  
Trees beginning 504' from DER, 487' left of centerline, up to 1020' MSL.  
Trees beginning 1256' from DER, 549' left of centerline, up to 1021' MSL.  
Trees beginning 1426' from DER, 533' left of centerline, up to 1033' MSL.  
Tree 1543' from DER, 714' right of centerline, 1025' MSL.  
Tree 1919' from DER, 853' left of centerline, 1035' MSL.  
Trees beginning 1992' from DER, 561' left of centerline, up to 1044' MSL.  
Trees beginning 2119' from DER, 654' left of centerline, up to 1048' MSL.  
Trees beginning 2487' from DER, 714' left of centerline, up to 1052' MSL.  
Trees beginning 2650' from DER, 990' left of centerline, up to 1053' MSL.  
Trees beginning 2891' from DER, 1122' left of centerline, up to 1054' MSL.

## CENTRE, AL

### CENTRE-PIEDMONT CHEROKEE COUNTY RGNL (PYP)

TAKEOFF MINIMUMS AND (OBSTACLE) DEPARTURE PROCEDURES  
ORIG 10APR08 (08101) (FAA)

DEPARTURE PROCEDURE:

**Rwy 7**, climb heading 067° to 1400 before turning South.  
**Rwy 25**, climb heading 247° to 2500 before turning South.

TAKEOFF OBSTACLE NOTES:

**Rwy 7**, multiple trees beginning 1481' from DER, 456' right of centerline up to 100' AGL/709' MSL.  
Multiple trees beginning 2273' from DER, 434' left of centerline up to 100' AGL/689' MSL.  
**Rwy 25**, multiple trees beginning 2780' from DER, 245' right of centerline up to 100' AGL/689' MSL.  
Tree 3093' from DER, 516' left of centerline 100' AGL/679' MSL.

## CENTREVILLE, AL

### BIBB COUNTY (0A8)

TAKEOFF MINIMUMS AND (OBSTACLE) DEPARTURE PROCEDURES  
ORIG 20DEC07 (07354) (FAA)

TAKEOFF MINIMUMS:

**Rwy 10**, 300-1¼ or std. w/ min. climb of 330' per NM to 600.  
**Rwy 28**, 300-2 or std. w/ min. climb of 300' per NM to 600.

DEPARTURE PROCEDURE:

**Rwy 10**, climb heading 097° to 1000 before turning left.

TAKEOFF OBSTACLE NOTES:

**Rwy 10**, brush 430' from DER, 42' right of centerline, 48' AGL/268' MSL.  
Trees beginning 4800' from DER, 1397' left of centerline, up to 100' AGL/479' MSL.  
**Rwy 28**, trees beginning at DER, 239' left of centerline, up to 100' AGL/339' MSL.  
Trees beginning at DER, 309' right of centerline, up to 100' AGL/499' MSL.

## CHATOM, AL

### ROY WILCOX (5R1)

TAKEOFF MINIMUMS AND (OBSTACLE) DEPARTURE PROCEDURES  
ORIG 29MAY14 (14149) (FAA)

TAKEOFF MINIMUMS:

**Rwy 12**, 300-1¼ or std. w/min. climb of 234' per NM to 400, or alternatively, with std. takeoff minimums and a normal 200' per NM climb gradient. Takeoff must occur no later than 1900' prior to DER.

TAKEOFF OBSTACLE NOTES:

**Rwy 12**, tree 17' from DER, 155' left of centerline, 100' AGL/223' MSL.  
Trees beginning 123' from DER, 171' right of centerline, up to 100' AGL/216' MSL.  
Trees beginning 290' from DER, 68' left of centerline, up to 100' AGL/259' MSL.  
Tree 1 NM from DER, 462' right of centerline, 100' AGL/309' MSL.  
**Rwy 30**, power pole and tree beginning 6' from DER, 197' left of centerline, up to 100' AGL/273' MSL.  
Trees and power pole beginning 95' from DER, 205' right of centerline, up to 100' AGL/272' MSL.  
Vehicles on road, poles and sign beginning 175' from DER, left and right of centerline, up to 15' AGL/189' MSL.  
Trees beginning 611' from DER, left and right of centerline, up to 100' AGL/258' MSL.

# TAKEOFF MINIMUMS, (OBSTACLE) DEPARTURE PROCEDURES, AND DIVERSE VECTOR AREA (RADAR VECTORS)

24025

SE-4

# TAKEOFF MINIMUMS, (OBSTACLE) DEPARTURE PROCEDURES, AND DIVERSE VECTOR AREA (RADAR VECTORS)

24025

## CLANTON, AL

### CHILTON COUNTY (02A)

#### TAKEOFF MINIMUMS AND (OBSTACLE) DEPARTURE PROCEDURES

AMDT 1 15SEP16 (16259) (FAA)

##### TAKEOFF MINIMUMS:

**Rwy 8**, 300-1¾ or std. w/min. climb of 520' per NM to 800.

##### DEPARTURE PROCEDURE:

**Rwy 26**, climb heading 262° to 1000 before turning north.

##### TAKEOFF OBSTACLE NOTES:

**Rwy 8**, catenary 135' from DER, 494' left of centerline, 51' AGL/611' MSL.  
Trees beginning 185' from DER, 328' left of centerline, up to 87' AGL/646' MSL.  
Tree, pole, bldg, flgpl beginning 389' from DER, 264' left of centerline, up to 101' AGL/657' MSL.  
Tree 612' from DER, 461' right of centerline, 77' AGL/644' MSL.  
Tree 767' from DER, 536' right of centerline, 83' AGL/657' MSL.  
Tree, pole beginning 936' from DER, 289' right of centerline, up to 103' AGL/679' MSL.  
Tree 1625' from DER, 782' left of centerline, 84' AGL/681' MSL.  
Trees beginning 1663' from DER, 578' left of centerline, up to 80' AGL/692' MSL.  
Tree, pole, vehicles on road beginning 1880' from DER, on centerline, up to 59' AGL/703' MSL.  
Tree, steeple, pole beginning 1981' from DER, 70' left of centerline, up to 90' AGL/701' MSL.  
Tree 2340' from DER, 926' right of centerline, 64' AGL/711' MSL.  
Tree, pole beginning 2362' from DER, 23' right of centerline, up to 91' AGL/720' MSL.  
Trees, poles beginning 2640' from DER, 177' right of centerline, up to 84' AGL/724' MSL.  
Trees, poles beginning 3180' from DER, 415' right of centerline, up to 108' AGL/732' MSL.  
Tree, pole beginning 3408' from DER, 9' left of centerline, up to 111' AGL/711' MSL.  
Tree, pole beginning 3536' from DER, 70' right of centerline, up to 94' AGL/736' MSL.  
Trees, pole beginning 4266' from DER, 155' left of centerline, up to 108' AGL/748' MSL.  
Tree, ant, pole beginning 4416' from DER, 619' right of centerline, up to 110' AGL/763' MSL.  
Tree, pole beginning 4688' from DER, 384' left of centerline, up to 95' AGL/752' MSL.  
Tree, pole beginning 4734' from DER, 1052' right of centerline, up to 95' AGL/772' MSL.  
Tree, pole beginning 4795' from DER, 313' right of centerline, up to 102' AGL/775' MSL.  
Trees beginning 4935' from DER, 45' left of centerline, up to 109' AGL/772' MSL.  
Trees beginning 1 NM from DER, 18' right of centerline, up to 99' AGL/777' MSL.  
Trees beginning 1.1 NM from DER, 15' left of centerline, up to 110' AGL/784' MSL.  
**Rwy 26**, pole 142' from DER, 444' left of centerline, 35' AGL/611' MSL.  
Grd, bldg beginning 200' from DER, 289' right of centerline, up to 15' AGL/608' MSL.  
Tree, pole beginning 375' from DER, 423' left of centerline, up to 79' AGL/662' MSL.  
Pole 428' from DER, 313' right of centerline, 35' AGL/628' MSL.  
Tree, pole beginning 454' from DER, 357' right of centerline, up to 69' AGL/665' MSL.  
Tree, vehicle on road, pole beginning 605' from DER, 4' right of centerline, up to 86' AGL/688' MSL.  
Tree, pole beginning 673' from DER, 381' left of centerline, up to 81' AGL/669' MSL.  
Trees, pole beginning 962' from DER, 13' right of centerline, up to 94' AGL/697' MSL.  
Tree, Pole beginning 1338' from DER, 30' left of centerline, up to 101' AGL/678' MSL.  
Tree, tank, water twr beginning 4449' from DER, 941' left of centerline, up to 110' AGL/729' MSL.

## CLAXTON, GA

### CLAXTON-EVANS COUNTY (CWV)

#### TAKEOFF MINIMUMS AND (OBSTACLE) DEPARTURE PROCEDURES

AMDT 1 30JAN20 (20030) (FAA)

##### TAKEOFF OBSTACLE NOTES:

**Rwy 10**, vegetation 13' from DER, 220' left of centerline, 99' MSL.  
Tree 93' from DER, 358' right of centerline, 153' MSL.  
Trees beginning 185' from DER, 389' right of centerline, up to 160' MSL.  
Trees beginning 259' from DER, 353' right of centerline, up to 178' MSL.  
Trees beginning 295' from DER, 530' left of centerline, up to 186' MSL.  
Trees beginning 420' from DER, 75' left of centerline, up to 189' MSL.  
Trees beginning 459' from DER, 519' right of centerline, up to 185' MSL.  
Trees beginning 530' from DER, 351' right of centerline, up to 191' MSL.  
Trees beginning 885' from DER, 27' right of centerline, up to 196' MSL.  
Trees beginning 3469' from DER, 232' left of centerline, up to 194' MSL.  
Tree 3728' from DER, 107' left of centerline, 197' MSL.  
**Rwy 28**, terrain 5' from DER, 358' right of centerline, 114' MSL.  
Vehicle on road beginning 58' from DER, 300' left of centerline, up to 126' MSL.  
Poles, vehicle on road, vegetation beginning 89' from DER, 315' right of centerline, up to 164' MSL.  
Vehicle on road beginning 149' from DER, 290' left of centerline, up to 127' MSL.  
Trees, vehicle on road, vegetation, poles, buildings beginning 276' from DER, 5' right of centerline, up to 195' MSL.  
Vehicle on road beginning 405' from DER, 290' left of centerline, up to 128' MSL.  
Tree, vehicle on road beginning 429' from DER, 4' left of centerline, up to 150' MSL.  
Trees, poles, sign beginning 634' from DER, 12' left of centerline, up to 170' MSL.  
Trees beginning 853' from DER, 158' right of centerline, up to 209' MSL.  
Trees, poles beginning 903' from DER, 110' right of centerline, up to 211' MSL.  
Trees beginning 1201' from DER, 645' left of centerline, up to 179' MSL.  
Trees beginning 1275' from DER, 3' left of centerline, up to 182' MSL.  
Trees beginning 1321' from DER, 30' left of centerline, up to 183' MSL.  
Trees, antenna, power line beginning 1374' from DER, 16' right of centerline, up to 223' MSL.  
CON'T

# TAKEOFF MINIMUMS, (OBSTACLE) DEPARTURE PROCEDURES, AND DIVERSE VECTOR AREA (RADAR VECTORS)

24025

SE-4

22 FEB 2024 to 21 MAR 2024

22 FEB 2024 to 21 MAR 2024

# TAKEOFF MINIMUMS, (OBSTACLE) DEPARTURE PROCEDURES, AND DIVERSE VECTOR AREA (RADAR VECTORS)

24025

## CLAXTON, GA (CON'T)

### CLAXTON-EVANS COUNTY (CWV) (CON'T)

**Rwy 28 (CON'T)**, trees beginning 2192' from DER, 28' left of centerline, up to 184' MSL.

Trees beginning 2273' from DER, 55' left of centerline, up to 186' MSL.

Trees beginning 2353' from DER, 33' left of centerline, up to 193' MSL.

Trees beginning 2375' from DER, 80' left of centerline, up to 197' MSL.

Trees beginning 2533' from DER, 12' left of centerline, up to 202' MSL.

## CLAYTON, AL

### CLAYTON MUNI (11A)

#### TAKEOFF MINIMUMS AND (OBSTACLE) DEPARTURE PROCEDURES

AMDT 3 15JUN23 (23166) (FAA)

##### TAKEOFF MINIMUMS:

**Rwy 10**, 300-2 or std. w/min. climb of 390' per NM to 800 or 1000-3 for VCOA.

**Rwy 28**, 300-1¼ or std. w/min. climb of 360' per NM to 800.

##### DEPARTURE PROCEDURE:

**Rwy 10**, climb on heading 101° to 900 before turning.

##### VCOA:

**Rwy 10**, obtain ATC approval for VCOA when requesting IFR clearance. Climb in visual conditions to cross Clayton Muni airport at or above 1200 before proceeding on course.

##### TAKEOFF OBSTACLE NOTES:

**Rwy 10**, tree 156' from DER, 397' left of centerline, 502' MSL.

Tree 2340' from DER, 764' left of centerline, 527' MSL.

Tree 2568' from DER, 7' right of centerline, 539' MSL.

Tree 2568' from DER, 113' right of centerline, 541' MSL.

Transmission line, tower beginning 5079' from DER, 592' left of centerline, up to 66' AGL/624' MSL.

Transmission line 5228' from DER, 1526' left of centerline, 75' AGL/631' MSL.

Transmission line 5594' from DER, 1456' left of centerline, 75' AGL/651' MSL.

Transmission line 5869' from DER, 1434' left of centerline, 70' AGL/658' MSL.

Transmission line beginning 1 NM from DER, 1398' left of centerline, up to 70' AGL/665' MSL.

Transmission line, tree beginning 1.1. NM from DER, 979' left of centerline, up to 70' AGL/694' MSL.

Tank 1.1 NM from DER, 634' right of centerline, 134' AGL/722' MSL.

Tree 1.6 NM from DER, 834' right of centerline, 694' MSL.

**Rwy 28**, tree 1433' from DER, 714' left of centerline, 514' MSL.

Tree 1915' from DER, 411' right of centerline, 519' MSL.

Tree 2052' from DER, 434' right of centerline, 521' MSL.

Tree 1.1 NM from DER, 731' left of centerline, 605' MSL.

Tree 1.4 NM from DER, 2360' right of centerline, 659' MSL.

## COCHRAN, GA

### COCHRAN (48A)

#### TAKEOFF MINIMUMS AND (OBSTACLE) DEPARTURE PROCEDURES

AMDT 2A 30NOV23 (23334) (FAA)

##### DEPARTURE PROCEDURE:

**Rwy 5**, climb on heading 049° to 1800 before turning left.

**Rwy 11**, climb on heading 107° to 1200 before turning left.

**Rwy 23**, climb on heading 229° to 900 before proceeding on course.

**Rwy 29**, climb on heading 287° to 1000 before turning right.

##### TAKEOFF OBSTACLE NOTES:

**Rwy 5**, trees beginning 4' from DER, 191' left of centerline, up to 371' MSL.

Trees beginning 357' from DER, 297' right of centerline, up to 368' MSL.

Trees beginning 407' from DER, 158' right of centerline, up to 372' MSL.

Trees beginning 682' from DER, 370' left of centerline, up to 375' MSL.

Trees beginning 686' from DER, 183' right of centerline, up to 374' MSL.

Tree 883' from DER, 394' left of centerline, 377' MSL.

Trees beginning 933' from DER, 23' right of centerline, up to 377' MSL.

Tree 938' from DER, 583' left of centerline, 379' MSL.

Tree 962' from DER, 739' left of centerline, 382' MSL.

Tree 1044' from DER, 428' left of centerline, 383' MSL.

Trees beginning 1138' from DER, 355' left of centerline, up to 387' MSL.

Trees beginning 1220' from DER, 256' left of centerline, up to 389' MSL.

Trees beginning 1354' from DER, 6' left of centerline, up to 395' MSL.

**Rwy 11**, terrain beginning 25' from DER, 284' left of centerline, up to 340' MSL.

Agricultural equipment 166' from DER, 331' right of centerline, 15' AGL/344' MSL.

Trees beginning 1105' from DER, 179' right of centerline, up to 400' MSL.

Tree 1212' from DER, 757' left of centerline, 378' MSL.

Trees beginning 1272' from DER, 612' left of centerline, up to 390' MSL.

Tree 2362' from DER, 415' left of centerline, 406' MSL.

**Rwy 23**, trees beginning 4' from DER, 370' right of centerline, up to 363' MSL.

Trees beginning 42' from DER, 285' left of centerline, up to 362' MSL.

Trees beginning 91' from DER, 239' left of centerline, up to 368' MSL.

Trees beginning 236' from DER, 403' right of centerline, up to 374' MSL.

Trees beginning 293' from DER, 1' left of centerline, up to 398' MSL.

CON'T

# TAKEOFF MINIMUMS, (OBSTACLE) DEPARTURE PROCEDURES, AND DIVERSE VECTOR AREA (RADAR VECTORS)

24025

SE-4

# TAKEOFF MINIMUMS, (OBSTACLE) DEPARTURE PROCEDURES, AND DIVERSE VECTOR AREA (RADAR VECTORS)

24025

## COCHRAN, GA (CON'T)

### COCHRAN (48A) (CON'T)

**Rwy 23 (CON'T)**, trees, pole beginning 687' from DER, 89' right of centerline, up to 388' MSL.

Trees beginning 1189' from DER, 62' right of centerline, up to 412' MSL.

Trees beginning 1402' from DER, 42' left of centerline, up to 401' MSL.

Trees beginning 1578' from DER, 10' left of centerline, up to 402' MSL.

Trees beginning 1792' from DER, 123' right of centerline, up to 414' MSL.

Tree 1847' from DER, 380' right of centerline, 417' MSL.

Tree 1860' from DER, 877' right of centerline, 423' MSL.

Trees beginning 1885' from DER, 12' right of centerline, up to 424' MSL.

Trees beginning 1921' from DER, 142' left of centerline, up to 411' MSL.

Trees beginning 2139' from DER, 412' left of centerline, up to 423' MSL.

Trees beginning 2342' from DER, 106' left of centerline, up to 424' MSL.

Trees beginning 2470' from DER, 125' left of centerline, up to 425' MSL.

Trees beginning 2605' from DER, 692' left of centerline, up to 427' MSL.

Tree 2705' from DER, 1211' left of centerline, 429' MSL.

Trees beginning 2707' from DER, 4' left of centerline, up to 430' MSL.

Trees beginning 2970' from DER, 29' left of centerline, up to 432' MSL.

Trees beginning 3349' from DER, 478' right of centerline, up to 427' MSL.

Trees beginning 4328' from DER, 1395' left of centerline, up to 446' MSL.

Tree 4614' from DER, 220' right of centerline, 443' MSL.

Trees beginning 4666' from DER, 151' right of centerline, up to 451' MSL.

Trees beginning 4690' from DER, 87' left of centerline, up to 473' MSL.

Trees beginning 4750' from DER, 30' right of centerline, up to 460' MSL.

**Rwy 29**, tree 43' from DER, 480' right of centerline, 444' MSL.

Tree, terrain beginning 61' from DER, 293' right of centerline, up to 460' MSL.

Trees, fence, terrain beginning 125' from DER, 333' right of centerline, up to 474' MSL.

Tree 217' from DER, 417' left of centerline, 397' MSL.

Trees beginning 284' from DER, 299' left of centerline, up to 416' MSL.

Trees beginning 406' from DER, 241' left of centerline, up to 418' MSL.

Trees beginning 494' from DER, 355' right of centerline, up to 475' MSL.

Trees beginning 557' from DER, 239' left of centerline, up to 421' MSL.

Trees beginning 627' from DER, 17' right of centerline, up to 480' MSL.

Trees beginning 734' from DER, 229' left of centerline, up to 422' MSL.

Trees beginning 853' from DER, 49' left of centerline, up to 426' MSL.

Trees beginning 1251' from DER, 239' left of centerline, up to 430' MSL.

Tree 1486' from DER, 336' left of centerline, 431' MSL.

Trees beginning 1543' from DER, 8' left of centerline, up to 434' MSL.

Tree 1823' from DER, 71' left of centerline, 447' MSL.

Trees beginning 1877' from DER, 151' left of centerline, up to 448' MSL.

Tree 1943' from DER, 8' left of centerline, 450' MSL.

Trees beginning 2019' from DER, 6' left of centerline, up to 453' MSL.

## COLUMBUS, GA

### COLUMBUS (CSG)

#### TAKEOFF MINIMUMS AND (OBSTACLE) DEPARTURE PROCEDURES

AMDT 7B 11AUG22 (22223) (FAA)

#### TAKEOFF MINIMUMS:

**Rwy 13**, std. w/min. climb of 205' per NM to 1200 or alternatively, with std. takeoff minimums and a normal 200' per NM climb gradient, takeoff must occur no later than 1200' prior to DER or 1700-3 for VCOA.

**Rwy 24**, std. w/min. climb of 225' per NM to 1800 or 1700-3 for VCOA.

**Rwy 31**, 300-3 or std. w/min. climb of 404' per NM to 700.

#### DEPARTURE PROCEDURE:

**Rwy 6**, climb heading 056° to 1400 before turning south.

**Rwy 13**, climb heading 070° to 2100 before turning south.

**Rwy 24**, climb heading 280° to 1900 before turning south.

**Rwy 31**, climb heading 309° to 1400 before turning south.

#### VCOA:

**Rwys 13, 24**, obtain ATC approval for VCOA when requesting IFR clearance. Climb in visual conditions to cross Columbus airport at or above 1900 before proceeding on course.

#### TAKEOFF OBSTACLE NOTES:

**Rwy 6**, vehicle on road, building and trees beginning 363' from DER, 6' left of centerline, up to 83' AGL/532' MSL. Trees beginning 748' from DER, 1' right of centerline, up to 51' AGL/501' MSL.

**Rwy 13**, tower, flagpole, and trees beginning 396' from DER, 132' left of centerline, up to 475' AGL/989' MSL.

Trees, bush, and electrical systems beginning 101' from DER, 55' right of centerline, up to 56' AGL/433' MSL.

**Rwy 24**, trees beginning 894' from DER, 195' left of centerline, up to 44' AGL/465' MSL.

Towers and trees beginning 2414' from DER, 298' right of centerline, up to 784' AGL/1404' MSL.

**Rwy 31**, vehicle on road, bush, signs, poles, tower, and trees beginning 319' from DER, 33' left of centerline, up to 183' AGL/598' MSL.

Trees, antenna, and vehicle on road beginning 319' from DER, 146' right of centerline, up to 100' AGL/569' MSL.

22 FEB 2024 to 21 MAR 2024

22 FEB 2024 to 21 MAR 2024

# TAKEOFF MINIMUMS, (OBSTACLE) DEPARTURE PROCEDURES, AND DIVERSE VECTOR AREA (RADAR VECTORS)

24025

SE-4

# TAKEOFF MINIMUMS, (OBSTACLE) DEPARTURE PROCEDURES, AND DIVERSE VECTOR AREA (RADAR VECTORS)

24025

## CORDELE, GA

### CRISP COUNTY-CORDELE (CKF)

#### TAKEOFF MINIMUMS AND (OBSTACLE) DEPARTURE PROCEDURES

AMDT 3 27APR17 (17117) (FAA)

#### TAKEOFF OBSTACLE NOTES:

- Rwy 6**, trees beginning 120' from DER, 376' left of centerline, up to 391' MSL.
- Tree 363' from DER, 531' right of centerline, 387' MSL.
- Tree 2313' from DER, 723' right of centerline, 389' MSL.
- Tree 2404' from DER, 788' right of centerline, 402' MSL.
- Trees beginning 2435' from DER, 323' right of centerline, up to 412' MSL.
- Rwy 10**, tree, pole beginning 22' from DER, 258' left of centerline, up to 353' MSL.
- RD (N) 435' from DER, 405' right of centerline, 326' MSL.
- Tree, building beginning 627' from DER, 281' right of centerline, up to 390' MSL.
- Tree 1153' from DER, 418' left of centerline, 386' MSL.
- Trees beginning 1238' from DER, 426' left of centerline, up to 397' MSL.
- Trees beginning 1730' from DER, 376' left of centerline, up to 409' MSL.
- Tree 4162' from DER, 253' right of centerline, 426' MSL.
- Rwy 24**, trees beginning 162' from DER, 463' left of centerline, up to 382' MSL.
- Trees beginning 340' from DER, 342' right of centerline, up to 391' MSL.
- Rwy 28**, tree 100' from DER, 384' right of centerline, 311' MSL.
- Tree 1199' from DER, 679' right of centerline, 370' MSL.
- Trees beginning 1235' from DER, 748' left of centerline, up to 372' MSL.
- Trees beginning 1760' from DER, 338' right of centerline, up to 391' MSL.
- Tree 2138' from DER, 107' left of centerline, 374' MSL.
- Trees beginning 2317' from DER, 412' left of centerline, up to 387' MSL.
- Tree 2537' from DER, 661' left of centerline, 388' MSL.
- Tree 3007' from DER, 277' right of centerline, 394' MSL.
- Tree 3205' from DER, 675' right of centerline, 400' MSL.

## CORNELIA, GA

### HABERSHAM COUNTY (AJR)

#### TAKEOFF MINIMUMS AND (OBSTACLE) DEPARTURE PROCEDURES

AMDT 5 27JAN22 (22027) (FAA)

#### TAKEOFF MINIMUMS:

- Rwy 6**, 400-2¼ or std. w/min. climb of 315' per NM to 1700.

#### DEPARTURE PROCEDURE:

- Rwy 6**, climb on heading 063° to 2200 before proceeding on course.
- Rwy 24**, climb on heading 243° to 1900 before proceeding on course.

#### TAKEOFF OBSTACLE NOTES:

- Rwy 6**, trees beginning 36' from DER, 10' left of centerline, up to 102' AGL/1509' MSL.
- Trees, pole beginning 64' from DER, 106' right of centerline, up to 1470' MSL.
- Trees beginning 381' from DER, 167' right of centerline, up to 1483' MSL.
- Trees beginning 511' from DER, 353' right of centerline, up to 1495' MSL.
- Trees beginning 634' from DER, 500' right of centerline, up to 1501' MSL.
- Trees beginning 719' from DER, 235' right of centerline, up to 1502' MSL.
- Tree, vehicles on road beginning 747' from DER, 28' right of centerline, up to 1519' MSL.
- Tree, building beginning 1207' from DER, 54' right of centerline, up to 1526' MSL.
- Tree 1406' from DER, 651' left of centerline, 1516' MSL.
- Tree, poles beginning 1487' from DER, 6' left of centerline, up to 1532' MSL.
- Trees beginning 1693' from DER, 19' right of centerline, up to 1530' MSL.
- Trees beginning 1805' from DER, 140' right of centerline, up to 1532' MSL.
- Tree 1892' from DER, 725' right of centerline, 1537' MSL.
- Tree 1894' from DER, 853' right of centerline, 1540' MSL.
- Trees beginning 1909' from DER, 34' right of centerline, up to 1552' MSL.
- Tree, buildings beginning 2215' from DER, 3' left of centerline, up to 100' AGL/1542' MSL.
- Trees beginning 2241' from DER, 187' right of centerline, up to 127' AGL/1555' MSL.
- Trees beginning 2244' from DER, 61' right of centerline, up to 128' AGL/1556' MSL.
- Trees beginning 2263' from DER, 18' right of centerline, up to 128' AGL/1557' MSL.
- Tree 2286' from DER, 171' right of centerline, 130' AGL/1558' MSL.
- Trees beginning 2289' from DER, 12' right of centerline, up to 1560' MSL.
- Trees beginning 2313' from DER, 34' right of centerline, up to 132' AGL/1561' MSL.
- Trees beginning 2360' from DER, 28' right of centerline, up to 134' AGL/1565' MSL.
- Trees beginning 2459' from DER, 101' right of centerline, up to 1566' MSL.
- Trees beginning 2478' from DER, 21' right of centerline, up to 132' AGL/1569' MSL.
- Trees beginning 2539' from DER, 9' right of centerline, up to 1574' MSL.
- Trees beginning 2643' from DER, 38' right of centerline, up to 1576' MSL.
- Tree, poles, buildings, vehicles on road, electrical system beginning 2752' from DER, 3' right of centerline, up to 1590' MSL.
- Trees beginning 2773' from DER, 2' left of centerline, up to 1571' MSL.
- Trees beginning 3714' from DER, 23' left of centerline, up to 88' AGL/1575' MSL.
- Trees beginning 3975' from DER, 2' left of centerline, up to 91' AGL/1583' MSL.
- Trees beginning 4170' from DER, 32' right of centerline, up to 1600' MSL.
- Tanks, tree, poles beginning 4272' from DER, 4' right of centerline, up to 1614' MSL.
- Trees beginning 4789' from DER, 799' right of centerline, up to 1626' MSL.
- Trees beginning 4936' from DER, 1115' right of centerline, up to 1627' MSL.

CONT

# TAKEOFF MINIMUMS, (OBSTACLE) DEPARTURE PROCEDURES, AND DIVERSE VECTOR AREA (RADAR VECTORS)

24025

# TAKEOFF MINIMUMS, (OBSTACLE) DEPARTURE PROCEDURES, AND DIVERSE VECTOR AREA (RADAR VECTORS)

24025

## CORNELIA, GA (CON'T)

### HABERSHAM COUNTY (AJR) (CON'T)

**Rwy 6 (CON'T)**, trees beginning 5392' from DER, 1285' right of centerline, up to 1640' MSL.

Tree 5604' from DER, 1858' right of centerline, 1642' MSL.

Trees beginning 5636' from DER, 1414' right of centerline, up to 1654' MSL.

Tower 1.2 NM from DER, 288' right of centerline, 127' AGL/1656' MSL.

Buildings, tree beginning 1.2 NM from DER, 1939' right of centerline, up to 1669' MSL.

Trees beginning 1.3 NM from DER, 2238' right of centerline, up to 1673' MSL.

Tree 1.3 NM from DER, 2689' right of centerline, 1678' MSL.

Trees beginning 1.3 NM from DER, 2313' right of centerline, up to 1683' MSL.

Trees beginning 1.3 NM from DER, 2200' right of centerline, up to 1694' MSL.

Trees beginning 1.4 NM from DER, 2273' right of centerline, up to 1699' MSL.

Trees beginning 1.4 NM from DER, 1994' right of centerline, up to 1706' MSL.

Trees beginning 1.4 NM from DER, 2463' right of centerline, up to 1712' MSL.

Trees beginning 1.4 NM from DER, 1711' right of centerline, up to 1729' MSL.

Trees beginning 1.4 NM from DER, 1958' right of centerline, up to 1733' MSL.

Tree 1.6 NM from DER, 2691' right of centerline, 1739' MSL.

Tank, tree beginning 1.6 NM from DER, 2300' right of centerline, up to 96' AGL/1746' MSL.

Tank, tree, building beginning 1.6 NM from DER, 2378' right of centerline, up to 100' AGL/1750' MSL.

Trees beginning 1.6 NM from DER, 2391' right of centerline, up to 1751' MSL.

Tree 1.6 NM from DER, 2901' right of centerline, 1754' MSL.

**Rwy 24**, tree, pole beginning 94' from DER, 428' left of centerline, up to 1422' MSL.

Tree 196' from DER, 367' left of centerline, 66' AGL/1429' MSL.

Trees, terrain beginning 219' from DER, 120' left of centerline, up to 1436' MSL.

Tree, vehicles on road beginning 521' from DER, 411' right of centerline, up to 1464' MSL.

Tree 592' from DER, 517' right of centerline, 1467' MSL.

Tree, fence, vehicles on road, building beginning 597' from DER, 1' right of centerline, up to 1494' MSL.

Tree, general utility, fence beginning 748' from DER, 63' left of centerline, up to 1484' MSL.

Tree, vehicles on road, fence beginning 864' from DER, 4' left of centerline, up to 1486' MSL.

Tree, vehicles on road, fence beginning 966' from DER, 125' left of centerline, up to 1490' MSL.

Tree, vehicles on road, terrain beginning 1004' from DER, 15' left of centerline, up to 1498' MSL.

Tree, fence, vehicles on road, building, terrain, general utility, pole beginning 1144' from DER, 7' left of centerline, up to 75' AGL/1501' MSL.

Tree, building, vehicles on road, pole beginning 1334' from DER, 1' left of centerline, up to 79' AGL/1508' MSL.

Tree, pole, windmill farms beginning 1940' from DER, 1' left of centerline, up to 1509' MSL.

Trees beginning 2605' from DER, 388' left of centerline, up to 1515' MSL.

Trees beginning 2680' from DER, 10' left of centerline, up to 1520' MSL.

Trees beginning 2992' from DER, on centerline, up to 82' AGL/1507' MSL.

Trees beginning 3249' from DER, 28' left of centerline, up to 97' AGL/1521' MSL.

## COURTLAND, AL

### COURTLAND (9A4)

#### TAKEOFF MINIMUMS AND (OBSTACLE) DEPARTURE PROCEDURES

AMDT 2A 26APR18 (A18116) (FAA)

##### TAKEOFF MINIMUMS:

**Rwy 31**, 300-1½ or std. w/min. climb of 220' per NM to 900, or alternatively, with std. takeoff minimums and a normal 200' per NM climb gradient, takeoff must occur no later than 1600' prior to DER.

##### TAKEOFF OBSTACLE NOTES:

**Rwy 13**, terrain 34' from DER, 413' right of centerline, 573' MSL.

**Rwy 18**, tree 4707' from DER, 1588' right of centerline, 100' AGL/709' MSL.

**Rwy 31**, terrain 16' from DER, 484' right of centerline, 584' MSL.

Trees beginning 1864' from DER, left and right of centerline, up to 100' AGL/759' MSL.

**Rwy 36**, fence 192' from DER, 494' left of centerline, 6' AGL/591' MSL.

Vehicles on road beginning 567' from DER, left and right of centerline, 15' AGL/600' MSL.

Trees beginning 728' from DER, left and right of centerline, up to 100' AGL/658' MSL.

## CULLMAN, AL

### CULLMAN RGNL/FOLSOM FLD (CMD)

#### TAKEOFF MINIMUMS AND (OBSTACLE) DEPARTURE PROCEDURES

AMDT 2A 27JUN13 (22195) (FAA)

##### TAKEOFF MINIMUMS:

**Rwy 20**, 300-1¼ or std. w/min. climb of 585' per NM to 1300.

##### TAKEOFF OBSTACLE NOTES:

**Rwy 2**, rising terrain beginning 40' from DER, 125' right of centerline, up to 980' MSL.

Pole 1429' from DER, 665' right of centerline, 41' AGL/1006' MSL.

Trees beginning 1672' from DER, left and right of centerline, up to 100' AGL/1119' MSL.

**Rwy 20**, trees beginning at DER, 488' left of centerline, up to 99' AGL/1033' MSL.

Trees beginning at DER, 534' right of centerline, up to 79' AGL/994' MSL.

Building 436' from DER, 521' right of centerline, 20' AGL/953' MSL.

Building 725' from DER, 556' right of centerline, 23' AGL/954' MSL.

Trees beginning 1174' from DER, left and right of centerline, up to 125' AGL/1119' MSL.

Water tower, 1.5 NM from DER 960' left of centerline, 199' AGL/1184' MSL.

# TAKEOFF MINIMUMS, (OBSTACLE) DEPARTURE PROCEDURES, AND DIVERSE VECTOR AREA (RADAR VECTORS)

24025

SE-4

22 FEB 2024 to 21 MAR 2024

22 FEB 2024 to 21 MAR 2024



# TAKEOFF MINIMUMS, (OBSTACLE) DEPARTURE PROCEDURES, AND DIVERSE VECTOR AREA (RADAR VECTORS)

24025

## DALTON, GA

### DALTON MUNI (DNN)

#### TAKEOFF MINIMUMS AND (OBSTACLE) DEPARTURE PROCEDURES

AMDT 5 27APR17 (17117) (FAA)

##### TAKEOFF MINIMUMS:

**Rwy 14**, 300-1 and 211' per NM to 2800 or standard w/min. climb of 675' per NM to 1000 or 2300-3 for VCOA.

##### DEPARTURE PROCEDURE:

**Rwy 14**, climb heading 140° to 2800 before turning left.

**Rwy 32**, climb heading 320° to 2000 before proceeding on course.

##### VCOA:

**Rwy 14**, obtain ATC approval for VCOA when requesting IFR clearance. Climb in visual conditions to cross Dalton Muni at or above 2900 before proceeding on course.

##### TAKEOFF OBSTACLE NOTES:

**Rwy 14**, tree 117' from DER, 428' left of centerline, 695' MSL.

Tree 123' from DER, 428' left of centerline, 699' MSL.

Trees beginning 1356' from DER, 388' left of centerline, up to 737' MSL.

Trees beginning 1559' from DER, 90' left of centerline, up to 741' MSL.

Tree 1684' from DER, 91' right of centerline, 746' MSL.

Trees beginning 1752' from DER, 36' right of centerline, up to 760' MSL.

Trees beginning 1781' from DER, 171' left of centerline, up to 744' MSL.

Trees beginning 1903' from DER, 81' right of centerline, up to 768' MSL.

Trees beginning 2110' from DER, 778' left of centerline, up to 794' MSL.

Trees beginning 2320' from DER, 282' left of centerline, up to 858' MSL.

Trees and building beginning 2444' from DER, 2' left of centerline, up to 904' MSL.

**Rwy 32**, Tree 674' from DER, 549' right of centerline, 739' MSL.

Trees beginning 843' from DER, 514' right of centerline, up to 740' MSL.

Tree 1076' from DER, 630' right of centerline, 751' MSL.

Tree 1137' from DER, 673' left of centerline, 758' MSL.

Building and Trees beginning 1302' from DER, 507' left of centerline, up to 773' MSL.

Tree 1762' from DER, 920' left of centerline, 802' MSL.

Tree 1840' from DER, 903' left of centerline, 804' MSL.

Trees beginning 1853' from DER, 659' left of centerline, up to 806' MSL.

Tree 2309' from DER, 383' right of centerline, 767' MSL.

Trees beginning 2433' from DER, 274' left of centerline, up to 813' MSL.

Tree 2759' from DER, 148' right of centerline, 777' MSL.

Trees beginning 3262' from DER, 708' left of centerline, up to 830' MSL.

Trees beginning 3334' from DER, 218' right of centerline, up to 808' MSL.

Trees beginning 3339' from DER, 709' left of centerline, up to 831' MSL.

Trees beginning 3683' from DER, 973' left of centerline, up to 832' MSL.

Trees beginning 3881' from DER, 976' left of centerline, up to 836' MSL.

Tree 4129' from DER, 440' right of centerline, 812' MSL.

Trees beginning 4325' from DER, 976' left of centerline, up to 837' MSL.

Tree 4375' from DER, 1292' left of centerline, 843' MSL.

Trees beginning 4391' from DER, 292' left of centerline, up to 854' MSL.

## DAWSON, GA

### DAWSON MUNI (16J)

#### TAKEOFF MINIMUMS AND (OBSTACLE) DEPARTURE PROCEDURES

AMDT 1 26MAR20 (20086) (FAA)

##### TAKEOFF MINIMUMS:

**Rwy 32**, 300-1½ or std. w/min. climb of 312' per NM to 700 or alternatively, with std. takeoff minimums and a normal 200' per NM climb gradient, takeoff must occur no later than 1800' prior to DER.

##### TAKEOFF OBSTACLE NOTES:

**Rwy 14**, tree 12' from DER, 304' right of centerline, 336' MSL.

Trees beginning 88' from DER, 275' left of centerline, up to 342' MSL.

Trees beginning 104' from DER, 517' right of centerline, up to 338' MSL.

Trees beginning 113' from DER, 369' left of centerline, up to 348' MSL.

Trees beginning 312' from DER, 364' left of centerline, up to 361' MSL.

Tree 567' from DER, 483' right of centerline, 348' MSL.

Trees beginning 670' from DER, 358' right of centerline, up to 355' MSL.

Trees beginning 844' from DER, 480' left of centerline, up to 363' MSL.

Trees beginning 916' from DER, 490' right of centerline, up to 373' MSL.

Tree 1117' from DER, 626' left of centerline, 368' MSL.

Trees beginning 2434' from DER, 287' right of centerline, up to 389' MSL.

**Rwy 32**, trees beginning 131' from DER, 383' left of centerline, up to 384' MSL.

Trees beginning 310' from DER, 500' right of centerline, up to 373' MSL.

Trees beginning 679' from DER, 534' right of centerline, up to 388' MSL.

Trees beginning 935' from DER, 546' right of centerline, up to 390' MSL.

Tower 5535' from DER, 767' right of centerline, 168' AGL/498' MSL.

# TAKEOFF MINIMUMS, (OBSTACLE) DEPARTURE PROCEDURES, AND DIVERSE VECTOR AREA (RADAR VECTORS)

24025

SE-4

# TAKEOFF MINIMUMS, (OBSTACLE) DEPARTURE PROCEDURES, AND DIVERSE VECTOR AREA (RADAR VECTORS)

24025

## DECATUR, AL

PRYOR FLD RGNL (DCU)

TAKEOFF MINIMUMS AND (OBSTACLE) DEPARTURE PROCEDURES

AMDT 1 08JUN06 (22195) (FAA)

TAKEOFF OBSTACLE NOTES:

**Rwy 18**, multiple trees beginning 461' from DER, 179' right of centerline, up to 100' AGL/697' MSL.

**Rwy 36**, tree 2582' from DER, 791' right of centerline, 100' AGL/685' MSL.

## DEMOPOLIS, AL

DEMOPOLIS RGNL (DYA)

TAKEOFF MINIMUMS AND (OBSTACLE) DEPARTURE PROCEDURES

AMDT 1A 24JUL14 (14205) (FAA)

TAKEOFF MINIMUMS:

**Rwy 22**, 300-1 or std. w/ min. climb of 370' per NM to 400.

TAKEOFF OBSTACLE NOTES:

**Rwy 4**, trees beginning at DER, 196' left and 151' right of centerline up to 100' AGL/209' MSL.

**Rwy 22**, trees beginning 295' from DER, 245' right of centerline up to 100' AGL/209' MSL.

Stack 4902' from DER, 1717' right of centerline, 180' AGL/273' MSL.

Water tank 5607' from DER, 1066' right of centerline, 148' AGL/243' MSL.

Stack 4875' from DER, 2209' right of centerline, 295' AGL/391' MSL.

## DOBBINS ARB (KMGE)

MARIETTA, GA

TAKEOFF MINIMUMS AND (OBSTACLE) DEPARTURE PROCEDURES

AMDT 6 19MAY22 (22139) (USAF)

DEPARTURE PROCEDURE:

**Rwy 11**, std. w/min. climb of 254' per NM to 1600.

**Rwy 29**, std. w/min. climb of 249' per NM to 2200.

TAKEOFF OBSTACLE NOTES:

**Rwy 11**, multiple trees beginning 1111' from DER, left and right of centerline, up to 81' AGL/1110' MSL.

**Rwy 29**, pylon 2417' from DER, 1115' left of centerline, 36' AGL/1142' MSL.

Pylon 2539' from DER, 1016' left of centerline, 36' AGL/1143' MSL.

Pylon 2652' from DER, 910' left of centerline, 36' AGL/1138' MSL.

Multiple trees beginning 3017' from DER, left and right of centerline, up to 108' AGL/1216' MSL.

DIVERSE VECTOR AREA (RADAR VECTORS)

ORIG 07SEP23 (23250) (USAF)

**Rwy 11**, required min climb of 254'/NM to 1600.

**Rwy 29**, required min climb of 249'/NM to 2200.

## DONALSONVILLE, GA

DONALSONVILLE MUNI (17J)

TAKEOFF MINIMUMS AND (OBSTACLE) DEPARTURE PROCEDURES

AMDT 1 27JAN22 (22027) (FAA)

TAKEOFF OBSTACLE NOTES:

**Rwy 1**, terrain beginning 2' from DER, 250' right of centerline, up to 150' MSL.

Lighting 10' from DER, 59' left of centerline, 2' AGL/148' MSL.

Tree 573' from DER, 387' right of centerline, 173' MSL.

Tree 576' from DER, 535' right of centerline, 194' MSL.

Tree 581' from DER, 624' right of centerline, 195' MSL.

Trees beginning 639' from DER, 306' left of centerline, up to 177' MSL.

Pole 1507' from DER, 889' left of centerline, 44' AGL/186' MSL.

Pole 1785' from DER, 889' left of centerline, 50' AGL/192' MSL.

Trees beginning 1876' from DER, 875' left of centerline, up to 214' MSL.

Tree 2121' from DER, 1027' left of centerline, 229' MSL.

Trees beginning 2137' from DER, 763' left of centerline, up to 238' MSL.

**Rwy 19**, terrain 5' from DER, 296' left of centerline, 131' MSL.

Terrain 6' from DER, 497' left of centerline, 132' MSL.

Vegetation 31' from DER, 195' left of centerline, 135' MSL.

Tree 412' from DER, 488' right of centerline, 168' MSL.

Tree and pole beginning 508' from DER, 610' right of centerline, up to 178' MSL.

Tree 655' from DER, 611' right of centerline, 193' MSL.

Trees beginning 667' from DER, 392' right of centerline, up to 208' MSL.

Trees beginning 1944' from DER, 479' right of centerline, up to 217' MSL.

Trees beginning 2002' from DER, 277' right of centerline, up to 228' MSL.

Trees beginning 3455' from DER, 1107' right of centerline, up to 235' MSL.

Trees beginning 3601' from DER, 665' right of centerline, up to 241' MSL.

# TAKEOFF MINIMUMS, (OBSTACLE) DEPARTURE PROCEDURES, AND DIVERSE VECTOR AREA (RADAR VECTORS)

24025

# TAKEOFF MINIMUMS, (OBSTACLE) DEPARTURE PROCEDURES, AND DIVERSE VECTOR AREA (RADAR VECTORS)

24025

## DOTHAN, AL

DOTHAN RGNL (DHN)

TAKEOFF MINIMUMS AND (OBSTACLE) DEPARTURE PROCEDURES

ORIG-A 16DEC10 (10350) (FAA)

TAKEOFF OBSTACLE NOTES:

**Rwy 18**, trees beginning 2047' from DER, 54' right of centerline, up to 75' AGL/457' MSL.

Pole 1434' from DER, 263' left of centerline, 48' AGL/418' MSL.

**Rwy 32**, trees beginning 418' from DER, 575' left of centerline, up to 59' AGL/430' MSL.

REILs beginning 43' from DER, 150' left and 137' right of centerline, up to 3' AGL/402' MSL.

**Rwy 36**, trees beginning 628' from DER, 362' right of centerline, up to 45' AGL/424' MSL.

Tree 339' from DER, 489' right of centerline, 55' AGL/434' MSL.

Trees beginning 629' from DER, 122' right of centerline, up to 41' AGL/426' MSL.

Trees beginning 549' from DER, 309' right of centerline, up to 63' AGL/453' MSL.

Tree 1172' from DER, 58' left of centerline, 50' AGL/435' MSL.

Trees beginning 3662' from DER, left and right of centerline, up to 88' AGL/493' MSL.

Tree 1037' from DER, 676' right of centerline, 93' AGL/453' MSL.

## DOUGLAS, GA

DOUGLAS MUNI (DQH)

TAKEOFF MINIMUMS AND (OBSTACLE) DEPARTURE PROCEDURES

AMDT 2 18NOV10 (10322) (FAA)

TAKEOFF MINIMUMS:

**Rwy 4**, std. with a min. climb of 250' per NM to 1100 or 900-2½ for climb in visual conditions.

DEPARTURE PROCEDURE:

**Rwy 4**, for climb in visual conditions cross Douglas Muni at or above 1100 before proceeding on course.

TAKEOFF OBSTACLE NOTES:

**Rwy 4**, light poles beginning 408' from DER, 408' right of centerline, up to 100' AGL/291' MSL.

Vehicle on road 20' from DER, 417' right of centerline, 15' AGL/271' MSL.

Vehicle on road 20' from DER, 418' left of centerline, 15' AGL/271' MSL.

**Rwy 22**, trees beginning 13' from DER, 400' right of centerline, up to 100' AGL/349' MSL.

## DUBLIN, GA

W. H. "BUD" BARRON (DBN)

TAKEOFF MINIMUMS AND (OBSTACLE) DEPARTURE PROCEDURES

AMDT 1 30AUG07 (07242) (FAA)

TAKEOFF OBSTACLE NOTES:

**Rwy 2**, trees beginning 2028' from DER, 810' left of centerline, up to 100' AGL/419' MSL.

Interstate with vehicle 754' from DER, 88' right of centerline, 17' AGL/326' MSL.

**Rwy 20**, trees beginning 2766' from DER, 839' right of centerline, up to 100' AGL/419' MSL.

Road with vehicle 850' from DER, 91' left of centerline, 15' AGL/285' MSL.

**Rwy 14**, trees beginning 1904' from DER, 167' right of centerline, up to 100' AGL/409' MSL.

Trees beginning 1764' from DER, 67' left of centerline, up to 100' AGL/399' MSL.

**Rwy 32**, trees beginning 1034' from DER, 193' right of centerline, up to 100' AGL/409' MSL.

Trees beginning 1052' from DER, 220' left of centerline, up to 100' AGL/489' MSL.

## EASTMAN, GA

HEART OF GEORGIA RGNL (EZM)

TAKEOFF MINIMUMS AND (OBSTACLE) DEPARTURE PROCEDURES

ORIG 12MAY05 (05132) (FAA)

TAKEOFF OBSTACLE NOTES:

**Rwy 2**, trees 2272' from DER, 106' right of centerline, 100' AGL/429' MSL.

Trees 2833' from DER, 505' right of centerline, 100' AGL/439' MSL.

Trees 3332' from DER, 1130' right of centerline, 100' AGL/449' MSL.

**Rwy 20**, trees 802' from DER, 510' left of centerline, 100' AGL/379' MSL.

Trees 1081' from DER, 126' right of centerline, 100' AGL/369' MSL.

## ELBERTON, GA

ELBERT COUNTY-PATZ FLD (EBA)

TAKEOFF MINIMUMS AND (OBSTACLE) DEPARTURE PROCEDURES

AMDT 1 12DEC13 (22195) (FAA)

TAKEOFF MINIMUMS:

**Rwy 29**, 300-1½ or std. w/min. climb of 487' per NM to 900.

TAKEOFF OBSTACLE NOTES:

**Rwy 11**, trees beginning 73' from DER, 180' right of centerline, up to 80' AGL/700' MSL.

Trees beginning 79' from DER, 497' left of centerline, up to 60' AGL/663' MSL.

Trees beginning 572' from DER, 527' left of centerline, up to 75' AGL/674' MSL.

Trees beginning 930' from DER, 278' left of centerline, up to 80' AGL/684' MSL.

Trees beginning 1367' from DER, 146' left of centerline, up to 100' AGL/685' MSL.

Trees beginning 1962' from DER, 7' right of centerline, up to 100' AGL/687' MSL.

Trees beginning 3693' from DER, 1225' right of centerline, up to 100' AGL/725' MSL.

CONT

# TAKEOFF MINIMUMS, (OBSTACLE) DEPARTURE PROCEDURES, AND DIVERSE VECTOR AREA (RADAR VECTORS)

24025

# TAKEOFF MINIMUMS, (OBSTACLE) DEPARTURE PROCEDURES, AND DIVERSE VECTOR AREA (RADAR VECTORS)

24025

## ELBERTON, GA (CON'T)

### ELBERT COUNTY-PATZ FLD (EBA) (CON'T)

**Rwy 29**, tree 43' from DER, 187' left of centerline, 25' AGL/625' MSL.

Tree 69' from DER, 475' left of centerline, 90' AGL/697' MSL.

Vehicles on road beginning 94' from DER, 171' right of centerline, up to 15' AGL/631' MSL.

Tree 132' from DER, 245' right of centerline, 60' AGL/664' MSL.

Trees beginning 160' from DER, left and right of centerline, up to 100' AGL/721' MSL.

Poles, vertical structure and vehicles beginning 929' from DER, 219' right of centerline, up to 62' AGL/700' MSL.

Trees and poles beginning 1566' from DER, left and right of centerline, up to 100' AGL/734' MSL.

Trees beginning 2479' from DER, left and right of centerline, up to 100' AGL/757' MSL.

Buildings beginning 2665' from DER, 709' right of centerline, up to 36' AGL/697' MSL.

Trees, buildings, poles beginning 2956' from DER, left and right of centerline, up to 100' AGL/769' MSL.

## ELLIJAY, GA

### GILMER COUNTY (49A)

#### TAKEOFF MINIMUMS AND (OBSTACLE) DEPARTURE PROCEDURES

ORIG 13SEP18 (18256) (FAA)

##### TAKEOFF MINIMUMS:

**Rwy 3**, std. w/min. climb of 350' per NM to 4800 or 3500 - 3 for VCOA.

##### DEPARTURE PROCEDURE:

**Rwy 3**, climb on heading 033° to 3300 before proceeding on course.

**Rwy 21**, climb on heading 213° to 2500 before turning left.

##### VCOA:

**Rwy 3**, obtain ATC approval for VCOA when requesting IFR clearance. Climb in visual conditions to cross Gilmer County Airport at or above 3500 before proceeding on course.

##### TAKEOFF OBSTACLE NOTES:

**Rwy 3**, trees beginning 97' from DER, 335' right of centerline, up to 1548' MSL.

Tree 147' from DER, 485' left of centerline, 1583' MSL.

Trees beginning 160' from DER, 8' left of centerline, up to 1594' MSL.

Trees beginning 271' from DER, 53' right of centerline, up to 1558' MSL.

Trees beginning 1510' from DER, 92' left of centerline, up to 1604' MSL.

Trees beginning 1655' from DER, 55' right of centerline, up to 1566' MSL.

Trees, pole beginning 1696' from DER, 1' left of centerline, up to 1620' MSL.

Trees beginning 2342' from DER, 61' right of centerline, up to 1567' MSL.

Tree 2438' from DER, 894' right of centerline, 1569' MSL.

Tree 2499' from DER, 837' right of centerline, 1571' MSL.

Trees beginning 2627' from DER, right of centerline, up to 1572' MSL.

Trees beginning 2725' from DER, 340' right of centerline, up to 1581' MSL.

Trees beginning 2778' from DER, 7' right of centerline, up to 1590' MSL.

Trees beginning 3301' from DER, right of centerline, up to 1597' MSL.

Trees beginning 3799' from DER, 161' left of centerline, up to 1628' MSL.

**Rwy 21**, terrain 104' from DER, 412' right of centerline, 1465' MSL.

Terrain 125' from DER, 187' right of centerline, 1468' MSL.

Terrain, tree beginning 153' from DER, 190' right of centerline, up to 1474' MSL.

Tree 159' from DER, 497' left of centerline, 1516' MSL.

Trees beginning 187' from DER, 228' left of centerline, up to 1532' MSL.

Tree 494' from DER, 484' right of centerline, 1525' MSL.

Tree 547' from DER, 321' right of centerline, 1528' MSL.

Trees beginning 605' from DER, 63' right of centerline, up to 1529' MSL.

Tree 3886' from DER, 1350' right of centerline, 1561' MSL.

Trees beginning 3962' from DER, 1352' right of centerline, up to 1570' MSL.

Trees beginning 4175' from DER, 1497' right of centerline, up to 1594' MSL.

## ENTERPRISE, AL

### ENTERPRISE MUNI (EDN)

#### TAKEOFF MINIMUMS AND (OBSTACLE) DEPARTURE PROCEDURES

ORIG 27AUG09 (09239) (FAA)

##### TAKEOFF OBSTACLE NOTES:

**Rwy 5**, trees beginning 260' from DER, 50' left of centerline, up to 100' AGL/469' MSL.

Tree 122' from DER, 177' right of centerline, 100' AGL/459' MSL.

**Rwy 23**, trees beginning 8' from DER, 203' right of centerline, up to 44' AGL/386' MSL.

Trees beginning 10' from DER, 336' left of centerline, up to 28' AGL/370' MSL.

22 FEB 2024 to 21 MAR 2024

22 FEB 2024 to 21 MAR 2024

# TAKEOFF MINIMUMS, (OBSTACLE) DEPARTURE PROCEDURES, AND DIVERSE VECTOR AREA (RADAR VECTORS)

24025

SE-4

# TAKEOFF MINIMUMS, (OBSTACLE) DEPARTURE PROCEDURES, AND DIVERSE VECTOR AREA (RADAR VECTORS)

24025

## EUFALA, AL

### WEEDON FLD (EUF)

#### TAKEOFF MINIMUMS AND (OBSTACLE) DEPARTURE PROCEDURES

AMDT 1 25AUG11 (21308) (FAA)

#### TAKEOFF OBSTACLE NOTES:

**Rwy 18**, trees beginning 661' from DER, 397' left of centerline, up to 100' AGL/324' MSL.

Pole 181' from DER, 353' left of centerline, 65' AGL/304' MSL.

Trees beginning 1207' from DER, 425' left of centerline, up to 100' AGL/360' MSL.

Trees beginning 2011' from DER, 335' right of centerline, up to 100' AGL/369' MSL.

**Rwy 36**, trees beginning 1097' from DER, 618' left of centerline, up to 100' AGL/380' MSL.

Trees beginning 16' from DER, 432' right of centerline, up to 100' AGL/376' MSL.

Trees beginning 2746' from DER, 325' left of centerline, up to 100' AGL/356' MSL.

## EVERGREEN, AL

### EVERGREEN RGNL/MIDDLETON FLD (GZH)

#### TAKEOFF MINIMUMS AND (OBSTACLE) DEPARTURE PROCEDURES

AMDT 2A 29MAR18 (22167) (FAA)

#### TAKEOFF MINIMUMS:

**Rwy 19**, 300-1% or std. w/min. climb of 215' per NM to 600, or alternatively, with std. takeoff minimums and a normal 200' per NM climb gradient, takeoff must occur no later than 1500' prior to DER.

**Rwy 28**, 300-1% or std. w/min. climb of 265' per NM to 600.

#### DEPARTURE PROCEDURE:

**Rwy 19**, climb heading 188° to 800 before turning left.

#### TAKEOFF OBSTACLE NOTES:

**Rwy 1**, trees beginning 316' from DER, left and right of centerline, up to 100' AGL/389' MSL.

Vehicles on road beginning 517' from DER, left and right of centerline, up to 17' AGL/294' MSL.

**Rwy 10**, rising terrain abeam DER, left and right of centerline, up to 259' MSL.

Trees beginning 242' from DER, left and right of centerline, up to 100' AGL/359' MSL.

**Rwy 19**, rising terrain abeam DER, left and right of centerline, up to 279' MSL.

Trees beginning 394' from DER, left and right of centerline, up to 100' AGL/469' MSL.

Vehicles on road beginning 696' from DER, left and right of centerline, up to 15' AGL/304' MSL.

**Rwy 28**, windsock 159' from DER, 498' right of centerline, 20' AGL/281' MSL.

Trees beginning 294' from DER, left and right of centerline, up to 100' AGL/489' MSL.

Antenna 342' from DER, 455' right of centerline, 30' AGL/288' MSL.

## FAIRHOPE, AL

### H L SONNY CALLAHAN (CQF)

#### TAKEOFF MINIMUMS AND (OBSTACLE) DEPARTURE PROCEDURES

AMDT 1 05MAY11 (11125) (FAA)

#### TAKEOFF OBSTACLE NOTES:

**Rwy 1**, trees beginning 824' from DER, left and right of centerline, up to 100' AGL/204' MSL.

## FAYETTE, AL

### RICHARD ARTHUR FLD (M95)

#### TAKEOFF MINIMUMS AND (OBSTACLE) DEPARTURE PROCEDURES

AMDT 2 19JUL18 (21364) (FAA)

#### TAKEOFF MINIMUMS:

**Rwy 1**, 400-2% or std. w/min. climb of 310' per NM to 600.

**Rwy 19**, 300-1% or std. w/min. climb of 280' per NM to 700.

#### DEPARTURE PROCEDURE:

**Rwy 19**, climb heading 186° to 1100 before proceeding on course.

#### TAKEOFF OBSTACLE NOTES:

**Rwy 1**, tower 39' from DER, 341' left of centerline, 40' AGL/399' MSL.

Vehicle on road 55' from DER, 232' right of centerline, 368' MSL.

Pole, vehicle on road beginning 67' from DER, 233' right of centerline, up to 13' AGL/370' MSL.

Pole 183' from DER, 399' right of centerline, 47' AGL/403' MSL.

pole, building, trees beginning 224' from DER, 188' right of centerline, up to 50' AGL/406' MSL.

Pole, building beginning 230' from DER, 381' left of centerline, up to 51' AGL/412' MSL.

Tree 414' from DER, 544' left of centerline, 423' MSL.

Trees, pole, building beginning 432' from DER, 94' left of centerline, up to 428' MSL.

Tree 709' from DER, 441' right of centerline, 412' MSL.

Trees, pole beginning 765' from DER, 199' right of centerline, up to 413' MSL.

Tree 897' from DER, 310' right of centerline, 415' MSL.

Trees beginning 942' from DER, 211' right of centerline, up to 458' MSL.

Trees, pole beginning 1168' from DER, 14' right of centerline, up to 478' MSL.

Tree 1704' from DER, 621' left of centerline, 444' MSL.

Trees, pole beginning 1724' from DER, 67' left of centerline, up to 452' MSL.

Trees, pole beginning 2188' from DER, 472' left of centerline, up to 454' MSL.

Trees, pole beginning 2398' from DER, 110' left of centerline, up to 468' MSL.

Trees, pole beginning 2780' from DER, 99' left of centerline, up to 476' MSL.

Tree 4114' from DER, 254' left of centerline, 494' MSL.

Trees beginning 4204' from DER, 104' left of centerline, up to 100' AGL/519' MSL.

CONT

# TAKEOFF MINIMUMS, (OBSTACLE) DEPARTURE PROCEDURES, AND DIVERSE VECTOR AREA (RADAR VECTORS)

24025

SE-4

# TAKEOFF MINIMUMS, (OBSTACLE) DEPARTURE PROCEDURES, AND DIVERSE VECTOR AREA (RADAR VECTORS)

24025

## FAYETTE, AL (CON'T)

### RICHARD ARTHUR FLD (M95) (CON'T)

**Rwy 1 (CON'T)**, tree 5929' from DER, 1980' left of centerline, 100' AGL/539' MSL.

Tree 1.8 NM from DER, 2957' left of centerline, 100' AGL/659' MSL.

**Rwy 19**, terrain abeam DER, 142' right of centerline, 331' MSL.

Trees beginning 41' from DER, 377' left of centerline, up to 343' MSL.

Terrain 95' from DER, 309' right of centerline, 335' MSL.

Tree 230' from DER, 322' right of centerline, 378' MSL.

Trees beginning 236' from DER, 252' right of centerline, up to 401' MSL.

Tree 241' from DER, 359' left of centerline, 363' MSL.

Tree 254' from DER, 246' left of centerline, 374' MSL.

Tree 391' from DER, 332' right of centerline, 402' MSL.

Trees beginning 406' from DER, 380' right of centerline, up to 435' MSL.

Trees beginning 415' from DER, 367' left of centerline, up to 411' MSL.

Trees beginning 536' from DER, 273' left of centerline, up to 418' MSL.

Arch 1 NM from DER, 1396' right of centerline, 549' MSL.

## FITZGERALD, GA

### FITZGERALD MUNI (FZG)

#### TAKEOFF MINIMUMS AND (OBSTACLE) DEPARTURE PROCEDURES

AMDT 1A 05MAR15 (15064) (FAA)

##### TAKEOFF MINIMUMS:

**Rwys 15, 33**, NA - Environmental.

##### DEPARTURE PROCEDURE:

**Rwy 2**, climbing right turn heading 037° to 1000 before turning left.

##### TAKEOFF OBSTACLE NOTES:

**Rwy 2**, trees beginning abeam DER, 96' left of centerline, up to 85' AGL/464' MSL.

Trees beginning 329' from DER, 10' right of centerline, up to 100' AGL/455' MSL.

Power pole 414' from DER, 428' right of centerline, 21' AGL/381' MSL.

Building 783' from DER, 600' left of centerline, 8' AGL/389' MSL.

Power poles beginning 885' from DER, 229' left of centerline, up to 38' AGL/396' MSL.

**Rwy 20**, trees beginning 193' from DER, 452' left of centerline, up to 111' AGL/430' MSL.

Trees beginning 612' from DER, 379' right of centerline, up to 83' AGL/398' MSL.

## FLORALA, AL

### FLORALA MUNI (0J4)

#### TAKEOFF MINIMUMS AND (OBSTACLE) DEPARTURE PROCEDURES

ORIG 02JUL09 (09183) (FAA)

##### TAKEOFF OBSTACLE NOTES:

**Rwy 4**, trees beginning 14' from DER, 200' right of centerline, up to 100' AGL/419' MSL.

Trees beginning 470' from DER, 54' left of centerline, up to 100' AGL/429' MSL.

Vehicles on roadway beginning 417' from DER, left and right of centerline, up to 15' AGL/344' MSL.

**Rwy 22**, trees beginning 16' from DER, 275' right of centerline, up to 100' AGL/409' MSL.

Vehicles on roadway beginning 30' from DER, 298' right of centerline, up to 17' AGL/326' MSL.

Trees beginning 340' from DER, 230' left of centerline, up to 100' AGL/379' MSL.

Trees beginning 1164' from DER, left and right of centerline, up to 100' AGL/369' MSL.

## FOLEY, AL

### FOLEY MUNI (5R4)

#### TAKEOFF MINIMUMS AND (OBSTACLE) DEPARTURE PROCEDURES

AMDT 1 27AUG09 (09239) (FAA)

##### TAKEOFF MINIMUMS:

**Rwy 36**, std. w/ min. climb of 240' per NM to 2800, or 1200-2½ for climb in visual conditions.

##### DEPARTURE PROCEDURE:

**Rwy 36**, for climb in visual conditions, cross Foley Muni airport at or above 1100 before proceeding on course.

##### TAKEOFF OBSTACLE NOTES:

**Rwy 18**, fence 52' from DER, 341' right of centerline, 12' AGL/77' MSL.

Trees beginning 81' from DER, 339' left of centerline, up to 81' AGL/146' MSL.

Vehicles on roadway 444' from DER, left and right of centerline, up to 15' AGL/106' MSL.

Tree 1173' from DER, 558' right of centerline, 86' AGL/151' MSL.

Trees beginning 1815' from DER, left and right of centerline, up to 112' AGL/177' MSL.

**Rwy 36**, trees beginning 68' from DER, 360' left of centerline, up to 94' AGL/159' MSL.

Trees beginning 77' from DER, 365' right of centerline, up to 97' AGL/162' MSL.

Trees beginning 1126' from DER, left and right of centerline, up to 97' AGL/157' MSL.

Vehicles on roadway 1176' from DER, left and right of centerline, up to 15' AGL/98' MSL.

Pole 1216' from DER, 408' right of centerline, 35' AGL/95' MSL.

Pole 1357' from DER, 112' left of centerline, 36' AGL/101' MSL.

Pole 1513' from DER, 183' left of centerline, 39' AGL/104' MSL.

# TAKEOFF MINIMUMS, (OBSTACLE) DEPARTURE PROCEDURES, AND DIVERSE VECTOR AREA (RADAR VECTORS)

24025

SE-4

22 FEB 2024 to 21 MAR 2024

22 FEB 2024 to 21 MAR 2024

# TAKEOFF MINIMUMS, (OBSTACLE) DEPARTURE PROCEDURES, AND DIVERSE VECTOR AREA (RADAR VECTORS)

24025

## FORT PAYNE, AL

ISBELL FLD (4A9)

TAKEOFF MINIMUMS AND (OBSTACLE) DEPARTURE PROCEDURES

AMDT 1 23SEP10 (21308) (FAA)

TAKEOFF MINIMUMS:

**Rwy 4**, 400-2¼ or std. w/min. climb of 410' per NM to 1400.**Rwy 22**, 400-2 or std. w/min. climb of 290' per NM to 1600.

DEPARTURE PROCEDURE:

**Rwy 4**, climb heading 044° to 2400 before proceeding on course.**Rwy 22**, climb heading 224° to 2300 before proceeding on course.

TAKEOFF OBSTACLE NOTES:

**Rwy 4**, trees beginning 111' from DER, 75' right of centerline, up to 100' AGL/1119' MSL.

Poles beginning 879' from DER, 373' right of centerline, up to 125' AGL/1224' MSL.

Obstruction light on WSK 66' from DER, 328' right of centerline, 78' AGL/957' MSL.

Vehicles beginning 322' from DER, 285' right of centerline, up to 15' AGL/921' MSL.

Buildings beginning 217' from DER, 426' right of centerline, up to 21' AGL/920' MSL.

Fence beginning 494' from DER, 397' right of centerline, up to 6' AGL/892' MSL.

GRD beginning 292' from DER, 289' right of centerline, up to 879' MSL.

Trees beginning 569' from DER, 119' left of centerline, up to 100' AGL/973' MSL.

Poles beginning 176' from DER, 397' left of centerline, up to 40' AGL/919' MSL.

Building 935' from DER, 636' left of centerline, 39' AGL/918' MSL.

Vehicles beginning 82' from DER, 359' left of centerline, up to 15' AGL/887' MSL.

Fence 182' from DER, 299' left of centerline, 6' AGL/880' MSL.

**Rwy 22**, trees beginning 59' from DER, 122' left of centerline, 100' AGL/1319' MSL.

Vehicles beginning 1224' from DER, 101' left of centerline, up to 96' AGL/955' MSL.

Trees beginning 46' from DER, 101' right of centerline, up to 100' AGL/972' MSL.

Poles beginning 204' from DER, 17' right of centerline, up to 53' AGL/892' MSL.

Vehicles beginning 137' from DER, 292' right of centerline, up to 15' AGL/869' MSL.

Building 316' from DER, 476' right of centerline, 15' AGL/874' MSL.

## FORT STEWART (HINESVILLE), GA

WRIGHT AAF (FORT STEWART)/MIDCOAST RGNL (LHW)

TAKEOFF MINIMUMS AND (OBSTACLE) DEPARTURE PROCEDURES

AMDT 1 20JUN19 (19171) (FAA)

TAKEOFF MINIMUMS:

**Rwys 6R, 15R, 24L, 33L**, NA-Obstacles.

TAKEOFF OBSTACLE NOTES:

**Rwy 6L**, tree 42' from DER, 253' left of centerline, 40' MSL.

Tree 112' from DER, 249' left of centerline, 50' MSL.

Trees beginning 112' from DER, 311' left of centerline, up to 60' MSL.

Trees beginning 187' from DER, 384' right of centerline, up to 83' MSL.

Trees beginning 347' from DER, 475' right of centerline, up to 104' MSL.

Trees beginning 428' from DER, 232' left of centerline, up to 93' MSL.

Trees beginning 628' from DER, 430' right of centerline, up to 111' MSL.

Trees beginning 870' from DER, 557' left of centerline, up to 126' MSL.

Trees beginning 1007' from DER, 319' left of centerline, up to 128' MSL.

Tree 1057' from DER, 731' right of centerline, 132' MSL.

Trees beginning 1148' from DER, 11' right of centerline, up to 142' MSL.

Trees beginning 1230' from DER, 68' left of centerline, up to 132' MSL.

Trees beginning 1366' from DER, 39' left of centerline, up to 134' MSL.

**Rwy 6L (CON'T)**, trees beginning 2354' from DER, 116' left of centerline, up to 139' MSL.

Trees beginning 2843' from DER, 96' left of centerline, up to 146' MSL.

Trees beginning 3045' from DER, 34' right of centerline, up to 149' MSL.

Trees beginning 3134' from DER, 31' left of centerline, up to 152' MSL.

Trees beginning 3195' from DER, 96' left of centerline, up to 155' MSL.

Trees beginning 3303' from DER, 82' right of centerline, up to 150' MSL.

Trees beginning 3340' from DER, 73' left of centerline, up to 157' MSL.

Trees beginning 3425' from DER, 14' right of centerline, up to 151' MSL.

Trees beginning 4183' from DER, 659' right of centerline, up to 152' MSL.

Trees beginning 4344' from DER, 261' right of centerline, up to 154' MSL.

Trees beginning 4528' from DER, 636' right of centerline, up to 157' MSL.

Trees beginning 4644' from DER, 931' right of centerline, up to 160' MSL.

Tree 5255' from DER, 1871' left of centerline, 166' MSL.

**Rwy 15L**, trees beginning 190' from DER, 549' left of centerline, up to 116' MSL.

Trees beginning 1421' from DER, 680' right of centerline, up to 125' MSL.

Trees beginning 1495' from DER, 763' left of centerline, up to 122' MSL.

Trees beginning 1934' from DER, 166' left of centerline, up to 130' MSL.

Tree 2360' from DER, 1052' left of centerline, 131' MSL.

Tree 2399' from DER, 875' left of centerline, 132' MSL.

Trees beginning 2457' from DER, 940' left of centerline, up to 134' MSL.

Trees beginning 3091' from DER, 1091' right of centerline, up to 127' MSL.

Tree 3745' from DER, 1149' right of centerline, 136' MSL.

**Rwy 24R**, lighting 12' from DER, 29' left of centerline, 1' AGL/46' MSL.

Tree 23' from DER, 485' right of centerline, 55' MSL.

CON'T

# TAKEOFF MINIMUMS, (OBSTACLE) DEPARTURE PROCEDURES, AND DIVERSE VECTOR AREA (RADAR VECTORS)

24025

# TAKEOFF MINIMUMS, (OBSTACLE) DEPARTURE PROCEDURES, AND DIVERSE VECTOR AREA (RADAR VECTORS)

24025

## FORT STEWART (HINESVILLE), GA (CON'T)

### WRIGHT AAF (FORT STEWART)/MIDCOAST RGNL (LHW) (CON'T)

**Rwy 24R (CON'T)**, trees beginning 1124' from DER, 168' left of centerline, up to 144' MSL.

Tree 1170' from DER, 765' right of centerline, 137' MSL.

Trees beginning 1580' from DER, 77' right of centerline, up to 164' MSL.

Trees beginning 2046' from DER, 53' left of centerline, up to 149' MSL.

Trees beginning 2349' from DER, 324' left of centerline, up to 150' MSL.

Trees beginning 2445' from DER, 3' left of centerline, up to 153' MSL.

Trees beginning 2715' from DER, 1' right of centerline, up to 167' MSL.

Trees beginning 2761' from DER, 151' left of centerline, up to 168' MSL.

Trees beginning 2937' from DER, 150' right of centerline, up to 169' MSL.

Trees beginning 2973' from DER, 640' left of centerline, up to 170' MSL.

Trees beginning 3078' from DER, 828' left of centerline, up to 172' MSL.

Trees beginning 3238' from DER, 385' right of centerline, up to 181' MSL.

Trees beginning 3433' from DER, 304' right of centerline, up to 190' MSL.

**Rwy 33R**, tree 113' from DER, 371' left of centerline, 48' MSL.

Tree 570' from DER, 602' right of centerline, 139' MSL.

Tree 723' from DER, 623' right of centerline, 140' MSL.

Trees beginning 808' from DER, 706' right of centerline, up to 147' MSL.

Tree 1066' from DER, 766' left of centerline, 96' MSL.

Tree 1227' from DER, 765' left of centerline, 99' MSL.

Trees beginning 1430' from DER, 628' left of centerline, up to 100' MSL.

Trees beginning 1703' from DER, 626' left of centerline, up to 110' MSL.

Trees beginning 3055' from DER, 903' right of centerline, up to 151' MSL.

Trees beginning 3885' from DER, 327' right of centerline, up to 155' MSL.

Trees beginning 4102' from DER, 367' right of centerline, up to 162' MSL.

Tree 4244' from DER, 469' left of centerline, 145' MSL.

Trees beginning 4288' from DER, 710' left of centerline, up to 159' MSL.

Trees beginning 4454' from DER, 967' left of centerline, up to 160' MSL.

Trees beginning 4511' from DER, 388' left of centerline, up to 161' MSL.

Trees beginning 4705' from DER, 1252' left of centerline, up to 164' MSL.

Trees beginning 4908' from DER, 1451' left of centerline, up to 166' MSL.

## GADSDEN, AL

### NORTHEAST ALABAMA RGNL (GAD)

#### TAKEOFF MINIMUMS AND (OBSTACLE) DEPARTURE PROCEDURES

AMDT 4 09FEB12 (12040) (FAA)

##### TAKEOFF MINIMUMS:

**Rwy 18**, std. w/ min climb of 340' per NM to 1700 or 1300-2½ for climb in visual conditions.

**Rwy 36**, std. w/ min. climb of 307' per NM to 1500 or 1300-2 ½ for climb in visual conditions.

##### DEPARTURE PROCEDURE:

**Rwy 6**, climb heading 064° to 1300 before proceeding on course.

**Rwy 18**, for climb in visual conditions cross Northeast Alabama Rgnl Airport at or above 1700 before proceeding on course.

**Rwy 24**, climb heading 244° to 2000 before proceeding on course.

**Rwy 36**, climb heading 003° to 1100 before proceeding on course or for climb in visual conditions cross Northeast Alabama Rgnl Airport at or above 1700 before proceeding on course.

##### TAKEOFF OBSTACLE NOTES:

**Rwy 6**, trees beginning 899' from DER, 620' left of centerline, up to 100' AGL/609' MSL.

**Rwy 18**, trees beginning 362' from DER, 27' left of centerline, up to 100' AGL/648' MSL.

Trees beginning 1471' from DER, 220' right of centerline, up to 100' AGL/652' MSL.

**Rwy 36**, trees beginning 102' from DER, 261' right of centerline, up to 100' AGL/659' MSL.

Trees beginning 303' from DER, 70' left of centerline, up to 100' AGL/639' MSL.

Tower 6045' from DER, 1155' right of centerline, 160' AGL/705' MSL.

## GAINESVILLE, GA

### LEE GILMER MEML (GVL)

#### TAKEOFF MINIMUMS AND (OBSTACLE) DEPARTURE PROCEDURES

AMDT 1 30AUG07 (21168) (FAA)

##### TAKEOFF MINIMUMS:

**Rwy 5**, 300-1¼ or std. w/min. climb of 311' per NM to 1600.

##### DEPARTURE PROCEDURE:

**Rwy 5**, climb heading 055° to 2100 before proceeding on course.

**Rwy 11**, climb heading 110° to 1900 before turning north.

**Rwy 23**, climb heading 224° to 2700 before turning south.

##### TAKEOFF OBSTACLE NOTES:

**Rwy 5**, multiple trees beginning 662' from DER, 78' right of centerline, up to 93' AGL/1330' MSL.

Multiple trees and pole beginning 301' from DER, on centerline, up to 137' AGL/1361' MSL.

Chimney 2298' from DER, 618' left of centerline, 131' AGL/1349' MSL.

Building 73' from DER, 356' right of centerline, 18' AGL/1252' MSL.

Tower 6415' from DER, 404' left of centerline, 206' AGL/1426' MSL.

Tower 6538' from DER, 486' left of centerline, 214' AGL/1428' MSL.

**Rwy 11**, trees 770' from departure end of runway, on centerline, 60' AGL/1317' MSL.

CON'T

# TAKEOFF MINIMUMS, (OBSTACLE) DEPARTURE PROCEDURES, AND DIVERSE VECTOR AREA (RADAR VECTORS)

24025

SE-4



# TAKEOFF MINIMUMS, (OBSTACLE) DEPARTURE PROCEDURES, AND DIVERSE VECTOR AREA (RADAR VECTORS)

24025

## GAINESVILLE, GA (CON'T)

### LEE GILMER MEML (GVL) (CON'T)

**Rwy 23**, multiple trees beginning 443' from DER, 220' right of centerline, up to 98' AGL/1319' MSL.

Trees 415' from DER, 304' left of centerline, 86' AGL/1291' MSL.

**Rwy 29**, trees 1256' from DER, on centerline, 52' AGL/1306' MSL.

## GENEVA, AL

### GENEVA MUNI (33J)

#### TAKEOFF MINIMUMS AND (OBSTACLE) DEPARTURE PROCEDURES

##### AMDT 1 13SEP18 (18256) (FAA)

###### TAKEOFF MINIMUMS:

**Rwy 29**, 200-1% or std. w/min. climb of 225' per NM to 500.

###### DEPARTURE PROCEDURE:

**Rwy 11**, climb heading 111° to 2000 before turning right.

**Rwy 29**, climb heading 291° to 1300 before turning left.

###### TAKEOFF OBSTACLE NOTES:

**Rwy 11**, vehicle on road 238' from DER, 254' left of centerline, 17' AGL/125' MSL.

Trees 306' from DER, 305' left of centerline, up to 100' AGL/198' MSL.

Trees 193' from DER, 168' right of centerline up to 100' AGL/196' MSL.

**Rwy 29**, trees 407' from DER, 174' left of centerline up to 100' AGL/189' MSL.

Trees 1393' from DER, crossing centerline, up to 100' AGL/236' MSL.

Pole 1.2 NM from DER, 3' right of centerline up to 100' AGL/279' MSL.

## GREENSBORO, AL

### GREENSBORO MUNI (7A0)

#### TAKEOFF MINIMUMS AND (OBSTACLE) DEPARTURE PROCEDURES

##### ORIG 30NOV23 (23334) (FAA)

###### TAKEOFF OBSTACLE NOTES:

**Rwy 18**, vehicle on road 5' from DER, 315' left of centerline, 15' AGL/170' MSL.

Trees beginning 6' from DER, 169' right of centerline, up to 234' MSL.

Trees beginning 10' from DER, 130' right of centerline, up to 245' MSL.

Tree 13' from DER, 376' left of centerline, 229' MSL.

Trees beginning 53' from DER, 119' left of centerline, up to 233' MSL.

Trees beginning 767' from DER, 10' left of centerline, up to 256' MSL.

Trees beginning 1773' from DER, 9' right of centerline, up to 246' MSL.

**Rwy 36**, tree 9' from DER, 174' left of centerline, 264' MSL.

Tree 14' from DER, 356' right of centerline, 83' AGL/261' MSL.

Trees beginning 24' from DER, 349' right of centerline, up to 85' AGL/263' MSL.

Trees beginning 27' from DER, 162' left of centerline, up to 265' MSL.

Trees beginning 191' from DER, 186' left of centerline, up to 267' MSL.

Tree 1187' from DER, 736' right of centerline, 78' AGL/264' MSL.

Trees beginning 1251' from DER, 286' right of centerline, up to 86' AGL/270' MSL.

Trees beginning 1448' from DER, 2' right of centerline, up to 97' AGL/282' MSL.

Tree 1704' from DER, 627' left of centerline, 272' MSL.

Trees beginning 1729' from DER, 18' left of centerline, up to 275' MSL.

Trees beginning 2295' from DER, 81' left of centerline, up to 84' AGL/277' MSL.

Trees beginning 2444' from DER, 68' left of centerline, up to 279' MSL.

Trees beginning 2724' from DER, 8' left of centerline, up to 284' MSL.

Trees beginning 2889' from DER, 325' right of centerline, up to 90' AGL/285' MSL.

Trees beginning 2955' from DER, 207' right of centerline, up to 90' AGL/287' MSL.

Trees beginning 3722' from DER, 333' right of centerline, up to 84' AGL/288' MSL.

Trees beginning 3836' from DER, 182' right of centerline, up to 90' AGL/290' MSL.

Trees beginning 4183' from DER, 339' right of centerline, up to 81' AGL/291' MSL.

Trees beginning 4422' from DER, 324' right of centerline, up to 90' AGL/302' MSL.

Trees beginning 4711' from DER, 313' right of centerline, up to 307' MSL.

## GREENSBORO, GA

### GREENE COUNTY RGNL (CPP)

#### TAKEOFF MINIMUMS AND (OBSTACLE) DEPARTURE PROCEDURES

##### AMDT 3A 20APR23 (23110) (FAA)

###### TAKEOFF OBSTACLE NOTES:

**Rwy 7**, tree 66' from DER, 148' left of centerline, 8' AGL/692' MSL.

Tree 132' from DER, 513' left of centerline, 738' MSL.

Trees beginning 268' from DER, 527' left of centerline, up to 752' MSL.

Tree 831' from DER, 681' right of centerline, 721' MSL.

Trees beginning 926' from DER, 500' right of centerline, up to 81' AGL/732' MSL.

Trees, transmission line, pole beginning 1073' from DER, 29' left of centerline, up to 755' MSL.

Tree 1194' from DER, 661' right of centerline, 733' MSL.

Trees beginning 1305' from DER, 501' right of centerline, up to 734' MSL.

Trees beginning 1457' from DER, 449' right of centerline, up to 750' MSL.

Trees beginning 1592' from DER, 476' right of centerline, up to 93' AGL/754' MSL.

Trees beginning 1841' from DER, 84' right of centerline, up to 78' AGL/758' MSL.

CON'T

# TAKEOFF MINIMUMS, (OBSTACLE) DEPARTURE PROCEDURES, AND DIVERSE VECTOR AREA (RADAR VECTORS)

24025

SE-4

# TAKEOFF MINIMUMS, (OBSTACLE) DEPARTURE PROCEDURES, AND DIVERSE VECTOR AREA (RADAR VECTORS)

24025

## GREENSBORO, GA (CON'T)

### GREENE COUNTY RGNL (CPP) (CON'T)

**Rwy 7 (CON'T)**, trees beginning 2042' from DER, 76' right of centerline, up to 761' MSL.

Trees beginning 2152' from DER, 14' left of centerline, up to 87' AGL/763' MSL.

Tree 2511' from DER, 68' right of centerline, 768' MSL.

Trees beginning 2525' from DER, 188' right of centerline, up to 92' AGL/776' MSL.

Trees beginning 2651' from DER, 12' left of centerline, up to 101' AGL/771' MSL.

Trees beginning 2653' from DER, 33' right of centerline, up to 97' AGL/778' MSL.

**Rwy 25**, poles, fence beginning 1' from DER, 292' right of centerline, up to 712' MSL.

Terrain 38' from DER, 262' left of centerline, 680' MSL.

Tree 68' from DER, 416' left of centerline, 69' AGL/754' MSL.

Structures, building, poles beginning 105' from DER, 236' left of centerline, up to 72' AGL/755' MSL.

Buildings beginning 175' from DER, 505' right of centerline, up to 40' AGL/713' MSL.

Pole, NAVAID beginning 303' from DER, 250' right of centerline, up to 714' MSL.

Buildings, tree, pole, transmission line beginning 443' from DER, 180' right of centerline, up to 55' AGL/728' MSL.

Building 546' from DER, 497' right of centerline, 735' MSL.

Elevators, tanks, vehicle on road, trees beginning 568' from DER, 45' right of centerline, up to 75' AGL/747' MSL.

Trees, pole beginning 590' from DER, 35' left of centerline, up to 90' AGL/776' MSL.

Trees beginning 1648' from DER, 23' left of centerline, up to 119' AGL/779' MSL.

Trees beginning 2384' from DER, 6' right of centerline, up to 101' AGL/766' MSL.

Tower, trees beginning 2436' from DER, 290' left of centerline, up to 138' AGL/820' MSL.

## GREENVILLE, AL

### MAC CRENSHAW MEML (PRN)

#### TAKEOFF MINIMUMS AND (OBSTACLE) DEPARTURE PROCEDURES

AMDT 1 30SEP04 (21364) (FAA)

##### DEPARTURE PROCEDURE:

**Rwy 14**, climb via heading 142° to 900 before proceeding on course.

**Rwy 32**, climb via heading 322° to 900 before proceeding on course.

##### TAKEOFF OBSTACLE NOTES:

**Rwy 14**, tower 2934' from DER, 565' right of centerline, 104' AGL/528' MSL

Tree 1400' from DER, on centerline, 60' AGL/485' MSL.

## GRIFFIN, GA

### GRIFFIN-SPALDING COUNTY (6A2)

#### TAKEOFF MINIMUMS AND (OBSTACLE) DEPARTURE PROCEDURES

AMDT 1 26JUL12 (12208) (FAA)

##### TAKEOFF OBSTACLE NOTES:

**Rwy 14**, trees beginning 129' from DER, 261' right of centerline, up to 89' AGL/989' MSL.

Pole 168' from DER, 222' left of centerline, 35' AGL/ 961' MSL.

**Rwy 32**, trees beginning 456' from DER, 158' left of centerline, up to 100' AGL/ 1062' MSL.

Trees beginning 750' from DER, 78' right of centerline, up to 100' AGL/ 1087' MSL.

Tower 1379' from DER, 667' right of centerline, 119' AGL/ 1019' MSL.

Pole 1831' from DER, 421' left of centerline, 75' AGL/ 1022' MSL.

## GULF SHORES, AL

### GULF SHORES INTL/JACK EDWARDS FLD (JKA)

#### TAKEOFF MINIMUMS AND (OBSTACLE) DEPARTURE PROCEDURES

ORIG-A 29MAR18 (21336) (FAA)

##### TAKEOFF OBSTACLE NOTES:

**Rwy 17**, poles beginning 553' from DER, 197' right of centerline, up to 26' AGL/46' MSL.

Building and poles beginning 573' from DER, 202' right of centerline, up to 38' AGL/56' MSL.

**Rwy 27**, tree 829' from DER, 453' right of centerline, 51' MSL.

Tree, pole beginning 830' from DER, 14' right of centerline, up to 67' MSL.

Pole 1404' from DER, 138' left of centerline, 38' AGL/51' MSL.

Tree 1592' from DER, 439' right of centerline, 74' MSL.

Tree 1637' from DER, 394' left of centerline, 70' MSL.

Tree 1767' from DER, 309' right of centerline, 80' MSL.

Tree 1832' from DER, 120' left of centerline, 89' MSL.

Trees beginning 1949' from DER, 66' left of centerline, up to 98' MSL.

Tree 2091' from DER, 327' left of centerline, 103' MSL.

Trees beginning 2110' from DER, 175' right of centerline, up to 103' MSL.

**Rwy 35**, tree 211' from DER, 356' left of centerline, 50' AGL/69' MSL.

Building 570' from DER, 414' right of centerline, 30' AGL/53' MSL.

Tree 1217' from DER, 82' right of centerline, 50' AGL/70' MSL.

# TAKEOFF MINIMUMS, (OBSTACLE) DEPARTURE PROCEDURES, AND DIVERSE VECTOR AREA (RADAR VECTORS)

24025

SE-4

# TAKEOFF MINIMUMS, (OBSTACLE) DEPARTURE PROCEDURES, AND DIVERSE VECTOR AREA (RADAR VECTORS)

24025

## GUNTERSVILLE, AL

GUNTERSVILLE MUNI/JOE STARNES FLD (8A1)

TAKEOFF MINIMUMS AND (OBSTACLE) DEPARTURE PROCEDURES

AMDT 2 27APR17 (21336) (FAA)

TAKEOFF MINIMUMS:

**Rwy 6, 24**, NA, Environmental.

**Rwy 7**, 400-2½ w/min. climb gradient 295' per NM to 1600' or 1100-2½ for VCOA.

**Rwy 25**, std. w/min. climb of 245' per NM to 1500' or 1100-2½ for VCOA.

DEPARTURE PROCEDURE:

**Rwy 7**, climb heading 069° to 1100 before turning.

VCOA:

**Rwy 7**, obtain ATC approval for VCOA when requesting IFR clearance. Climb in visual conditions to cross Guntersville Muni/ Joe Starnes Fld at or above 1600 before proceeding on course.

**Rwy 25**, obtain ATC approval for VCOA when requesting IFR clearance. Climb in visual conditions to cross Guntersville Muni/Joe Starnes Fld at or above 1600 before proceeding on course.

TAKEOFF OBSTACLE NOTES:

**Rwy 7**, airfield light 8' from DER, 17' right of centerline, 2' AGL/616' MSL.

Airfield light 9' from DER, 16' left of centerline, 2' AGL/617' MSL.

Ground 90' from DER, 489' right of centerline, 617' MSL.

Ground 192' from DER, 492' right of centerline, 623' MSL.

Ground 292' from DER, 410' right of centerline, 625' MSL.

Vehicles on road, ground beginning 377' from DER, 406' right of centerline, up to 651' MSL.

Vehicles on road 497' from DER, 479' right of centerline, 652' MSL.

Tree, pole, ground beginning 568' from DER, 429' right of centerline, up to 715' MSL.

Tree, vehicles on road beginning 713' from DER, 433' right of centerline, up to 719' MSL.

Tree 1644' from DER, 573' left of centerline, 73' AGL/668' MSL.

Trees beginning 2310' from DER, 525' right of centerline, up to 722' MSL.

Trees beginning 2702' from DER, 847' right of centerline, up to 730' MSL.

Trees beginning 2911' from DER, 972' right of centerline, up to 740' MSL.

Trees beginning 3115' from DER, 775' right of centerline, up to 758' MSL.

Trees beginning 3323' from DER, 675' right of centerline, up to 761' MSL.

Trees beginning 3432' from DER, 699' right of centerline, up to 771' MSL.

Trees beginning 3537' from DER, 1110' right of centerline, up to 801' MSL.

Trees beginning 3590' from DER, 622' right of centerline, up to 805' MSL.

Trees beginning 3696' from DER, 935' right of centerline, up to 835' MSL.

Trees beginning 3696' from DER, 558' right of centerline, up to 846' MSL.

Trees beginning 3801' from DER, 404' right of centerline, up to 894' MSL.

Trees beginning 3801' from DER, 1062' right of centerline, up to 873' MSL.

Trees beginning 3960' from DER, 608' right of centerline, up to 911' MSL.

Trees beginning 4065' from DER, 549' right of centerline, up to 93' AGL/927' MSL.

Trees beginning 4171' from DER, 515' right of centerline, up to 100' AGL/928' MSL.

T-L tower 2.1 NM from DER, 2928' left of centerline, 351' AGL/951' MSL.

**Rwy 25**, pole 171' from DER, 48' right of centerline, 31' AGL/630' MSL.

Pole 347' from DER, 378' left of centerline, 633' MSL.

Tree, pole, antenna on building, apbn beginning 375' from DER, 22' left of centerline, up to 73' AGL/673' MSL.

Pole, pole beginning 407' from DER, 277' right of centerline, up to 636' MSL.

Pole beginning 620' from DER, 95' right of centerline, up to 40' AGL/640' MSL.

Tree 1067' from DER, 726' right of centerline, 651' MSL.

Tree 1193' from DER, 686' right of centerline, 675' MSL.

Trees beginning 1212' from DER, 418' left of centerline, up to 684' MSL.

Trees beginning 1215' from DER, 105' right of centerline, up to 721' MSL.

Trees beginning 1452' from DER, 467' left of centerline, up to 688' MSL.

Trees beginning 2175' from DER, 923' left of centerline, up to 693' MSL.

Tree 2425' from DER, 1146' left of centerline, 701' MSL.

## HALEYVILLE, AL

POSEY FLD (1M4)

TAKEOFF MINIMUMS AND (OBSTACLE) DEPARTURE PROCEDURES

ORIG-A 01JUL10 (22195) (FAA)

TAKEOFF OBSTACLE NOTES:

**Rwy 18**, trees beginning 2372' from DER, 1009' left of centerline, up to 78' AGL/1052' MSL.

Trees beginning 78' from DER, 257' right of centerline, up to 82' AGL/1021' MSL.

**Rwy 36**, trees beginning 7' from DER, 276' left of centerline, up to 75' AGL/1005' MSL.

Trees beginning 383' from DER, 277' right of centerline, up to 73' AGL/1003' MSL.

Fence 204' from DER, 202' right of centerline, 6' AGL/936' MSL.

# TAKEOFF MINIMUMS, (OBSTACLE) DEPARTURE PROCEDURES, AND DIVERSE VECTOR AREA (RADAR VECTORS)

24025

# TAKEOFF MINIMUMS, (OBSTACLE) DEPARTURE PROCEDURES, AND DIVERSE VECTOR AREA (RADAR VECTORS)

24025

## HAMILTON, AL

### MARION COUNTY-RANKIN FITE (HAB)

#### TAKEOFF MINIMUMS AND (OBSTACLE) DEPARTURE PROCEDURES

AMDT 1 15DEC11 (11349) (FAA)

##### TAKEOFF MINIMUMS:

**Rwy 18**, 400-2½ or std. w/min. climb of 390' per NM to 800.

**Rwy 36**, 400 - 2 ¼ or std. w/min. climb of 370' per NM to 900.

##### DEPARTURE PROCEDURE:

**Rwy 18**, climb heading 181° to 900 before turning left.

**Rwy 36**, climb heading 001° to 1000 before turning left.

##### TAKEOFF OBSTACLE NOTES:

**Rwy 18**, trees beginning 53' from DER, left and right of centerline, up to 100' AGL/699' MSL.

Trees beginning 1.5 NM from DER, 2172' left of centerline, up to 100' AGL/719' MSL.

**Rwy 36**, trees beginning 122' from DER, left and right of centerline, up to 100' AGL/573' MSL.

Building 2368' from DER, 411' right of centerline, 50' AGL/501' MSL.

Vehicles on roadway beginning 2511' from DER, 1124' left of centerline, up to 17' AGL/516' MSL.

Pole 3009' from DER, 309' left of centerline, 70' AGL/569' MSL.

Towers and trees beginning 1.1 NM from DER, left and right of centerline, up to 115' AGL/779' MSL.

## HANCHEY AHP (STRIP) (KHEY)

### FORT NOVOSEL, AL

#### TAKEOFF MINIMUMS AND (OBSTACLE) DEPARTURE PROCEDURES

ORIG 13JUL23 (23194) (USA)

##### TAKEOFF MINIMUMS

All helipads, NA-ATC.

##### DEPARTURE PROCEDURE:

**Rwy 17**, climb heading 182° to 800 before proceeding on course.

**Rwy 35**, climb heading 002° to 800 before proceeding on course.

##### TAKEOFF OBSTACLE NOTES:

**Rwy 17**, twr 4056' from DER, 434' right of centerline, 112' AGL/422' MSL.

## HARTSELLE, AL

### HARTSELLE/MORGAN COUNTY RGNL (5M0)

#### TAKEOFF MINIMUMS AND (OBSTACLE) DEPARTURE PROCEDURES

AMDT 2 05JUL07 (22027) (FAA)

##### TAKEOFF MINIMUMS:

**Rwy 36**, 500-2½ or std. with a min. climb of 260' per NM to 1200.

##### TAKEOFF OBSTACLE NOTES:

**Rwy 18**, trees abeam DER, 300' left of centerline, up to 100' AGL/739' MSL.

Multiple buildings 150' from DER, 432' left of centerline, up to 40' AGL/679' MSL.

Multiple trees 265' from DER, 133' right of centerline, up to 100' AGL/699' MSL.

**Rwy 36**, trees 3089' from DER, 426' left of centerline, 100' AGL/779' MSL.

Trees 1139' from DER, 98' right of centerline, 45' AGL/673' MSL.

Tower 1.85 NM from DER, 2953' left of centerline, 249' AGL/928' MSL.

Multiple buildings beginning 755' from DER, 775' right of centerline, up to 40' AGL/689' MSL.

Tower 2.15 NM from DER, 295' left of centerline, 303' AGL/990' MSL.

## HAZLEHURST, GA

### HAZLEHURST (AZE)

#### TAKEOFF MINIMUMS AND (OBSTACLE) DEPARTURE PROCEDURES

AMDT 1 15JUN23 (23166) (FAA)

##### TAKEOFF OBSTACLE NOTES:

**Rwy 15**, trees beginning 13' from DER, 387' right of centerline, up to 307' MSL.

Trees beginning 69' from DER, 397' left of centerline, up to 332' MSL.

Trees, poles beginning 115' from DER, 41' left of centerline, up to 339' MSL.

Tree 196' from DER, 513' right of centerline, 309' MSL.

Trees beginning 314' from DER, 389' right of centerline, up to 314' MSL.

Tree 373' from DER, 511' right of centerline, 322' MSL.

Trees beginning 431' from DER, 396' right of centerline, up to 326' MSL.

Trees beginning 683' from DER, 493' right of centerline, up to 337' MSL.

Trees, antennas, pole beginning 879' from DER, 7' right of centerline, up to 350' MSL.

Trees beginning 1637' from DER, 40' left of centerline, up to 88' AGL/343' MSL.

Tree 2760' from DER, 324' left of centerline, 350' MSL.

Trees beginning 2777' from DER, 9' left of centerline, up to 355' MSL.

Trees beginning 3299' from DER, 13' left of centerline, up to 366' MSL.

Trees beginning 3613' from DER, 58' right of centerline, up to 353' MSL.

Trees beginning 3656' from DER, 41' left of centerline, up to 369' MSL.

**Rwy 33**, light poles 10' from DER, 97' left of centerline, 3' AGL/222' MSL.

Trees beginning 210' from DER, 277' right of centerline, up to 281' MSL.

Trees beginning 276' from DER, 145' right of centerline, up to 293' MSL.

Trees beginning 291' from DER, 221' left of centerline, up to 270' MSL.

Trees beginning 1411' from DER, 23' left of centerline, up to 272' MSL.

Tree 2025' from DER, 1011' left of centerline, 277' MSL.

# TAKEOFF MINIMUMS, (OBSTACLE) DEPARTURE PROCEDURES, AND DIVERSE VECTOR AREA (RADAR VECTORS)

24025

SE-4

# TAKEOFF MINIMUMS, (OBSTACLE) DEPARTURE PROCEDURES, AND DIVERSE VECTOR AREA (RADAR VECTORS)

24025

## HEADLAND, AL

### HEADLAND MUNI (HDL)

#### TAKEOFF MINIMUMS AND (OBSTACLE) DEPARTURE PROCEDURES

ORIG-A 27JAN22 (22027) (FAA)

##### TAKEOFF MINIMUMS:

**Rwys 17, 35**, NA-Environmental.

##### TAKEOFF OBSTACLE NOTES:

**Rwy 9**, tree 6' from DER, 154' left of centerline, 366' MSL.

Tree 315' from DER, 431' left of centerline, 420' MSL.

Tree 351' from DER, 124' right of centerline, 366' MSL.

Tree 398' from DER, 566' right of centerline, 401' MSL.

Tree, pole beginning 418' from DER, 37' left of centerline, up to 422' MSL.

Trees beginning 1584' from DER, 8' left of centerline, up to 430' MSL.

Tree 1716' from DER, 526' right of centerline, 425' MSL.

**Rwy 27**, trees beginning 123' from DER, 471' right of centerline, up to 378' MSL.

Pole 1130' from DER, 65' left of centerline, 38' AGL/384' MSL.

Pole 1135' from DER, 160' right of centerline, 41' AGL/384' MSL.

Building 3301' from DER, 1014' left of centerline, 80' AGL/451' MSL.

## HOMERVILLE, GA

### HOMERVILLE (HOE)

#### TAKEOFF MINIMUMS AND (OBSTACLE) DEPARTURE PROCEDURES

AMDT 1 25JUN15 (15176) (FAA)

##### DEPARTURE PROCEDURE:

**Rwy 14**, climb heading 141° to 700 before proceeding on course.

##### TAKEOFF OBSTACLE NOTES:

**Rwy 14**, trees beginning 87' from DER, 290' right of centerline, up to 95' AGL/280' MSL.

Vehicle on road 270' from DER, 570' left of centerline, 15' AGL/197' MSL.

Trees beginning 969' from DER, 19' left of centerline, up to 104' AGL/283' MSL.

Trees beginning 1672' from DER, 63' right of centerline, up to 87' AGL/262' MSL.

Antenna 2809' from DER, 447' left of centerline, 112' AGL/291' MSL.

**Rwy 32**, trees beginning 10' from DER, 450' left of centerline, up to 14' AGL/199' MSL.

Vehicle on road 303' from DER, 578' right of centerline, 15' AGL/200' MSL.

Trees beginning 486' from DER, 591' right of centerline, up to 84' AGL/264' MSL.

Trees beginning 2007' from DER, 652' left of centerline, up to 89' AGL/269' MSL.

Trees beginning 2333' from DER, 690' right of centerline, up to 92' AGL/277' MSL.

## HUNTER AAF (KSVN)

### SAVANNAH, GA

#### TAKEOFF MINIMUMS AND (OBSTACLE) DEPARTURE PROCEDURES

AMDT 3 07SEP23 (23250) (USA)

##### TAKEOFF MINIMUMS:

**Rwy 28**, 300-1 or std w/min climb of 340'/NM to 400.

##### DEPARTURE PROCEDURE:

**Rwy 28**, climbing left turn hdg 230° to 1700 before proceeding on course.

##### TAKEOFF OBSTACLE NOTES:

**Rwy 10**, terrain 0' from DER, 500' left of centerline, 29' MSL.

**Rwy 28**, tank 2489' from DER, 3554' left of centerline, 118' AGL/137' MSL.

Twr 1140' from DER, 1802' left of centerline, 102' AGL/118' MSL.

Twr 2044' from DER, 1831' left of centerline, 102' AGL/117' MSL.

Twr 1500' from DER, 2319' left of centerline, 100' AGL/116' MSL.

Twr 1535' from DER, 1296' left of centerline, 100' AGL/115' MSL.

## HUNTSVILLE, AL

### HUNTSVILLE EXEC TOM SHARP JR FLD (MDQ)

#### TAKEOFF MINIMUMS AND (OBSTACLE) DEPARTURE PROCEDURES

AMDT 4B 25APR19 (22195) (FAA)

##### TAKEOFF MINIMUMS:

**Rwy 18**, std. w/min. climb of 350' per NM to 3200.

**Rwy 36**, 200-1½ or std. w/min. climb of 240' per NM to 1000.

##### DEPARTURE PROCEDURE:

**Rwy 36**, climb heading 005° to 1700 before proceeding on course.

##### TAKEOFF OBSTACLE NOTES:

**Rwy 18**, tree 5' from DER, 442' right of centerline, 5' AGL/765' MSL.

Multiple trees beginning 816' from DER, 551' right of centerline, up to 80' AGL/818' MSL.

Multiple trees beginning 5408' from DER, 126' right of centerline, up to 132' AGL/955' MSL.

CON'T

22 FEB 2024 to 21 MAR 2024

22 FEB 2024 to 21 MAR 2024

# TAKEOFF MINIMUMS, (OBSTACLE) DEPARTURE PROCEDURES, AND DIVERSE VECTOR AREA (RADAR VECTORS)

24025

SE-4

# TAKEOFF MINIMUMS, (OBSTACLE) DEPARTURE PROCEDURES, AND DIVERSE VECTOR AREA (RADAR VECTORS)

24025

## HUNTSVILLE, AL (CON'T)

### HUNTSVILLE EXEC TOM SHARP JR FLD (MDQ) (CON'T)

**Rwy 36**, REIL 10' from DER, 124' left of centerline, 5' AGL/721' MSL.

REIL 10' from DER, 124' right of centerline, 3' AGL/721' MSL.

Vehicles on road beginning 153' from DER, 491' right of centerline up to 15' AGL/725' MSL.

Multiple trees beginning 591' from DER, 476' right of centerline, up to 76' AGL/786' MSL.

Multiple trees beginning 788' from DER, 673' left of centerline, up to 84' AGL/794' MSL.

Multiple trees beginning 1 NM from DER, 11' right of centerline, up to 104' AGL/924' MSL.

Multiple trees beginning 1.1 NM from DER, 44' left of centerline, up to 129' AGL/931' MSL.

### HUNTSVILLE INTL-CARL T JONES FLD (HSV)

#### TAKEOFF MINIMUMS AND (OBSTACLE) DEPARTURE PROCEDURES

AMDT 4A 01FEB18 (21168) (FAA)

DEPARTURE PROCEDURE:

**Rwy 36R**, climb heading 005° to 1600 before turning right.

TAKEOFF OBSTACLE NOTES:

**Rwy 18L**, trees beginning 1088' from DER, 710' left of centerline, up to 100' AGL/660' MSL.

**Rwy 36L**, trees beginning 1911' from DER, 904' right of centerline, up to 100' AGL/719' MSL.

Trees beginning 3693' from DER, 1392' left of centerline, up to 100' AGL/749' MSL.

**Rwy 36R**, fence 383' from DER, 602' right of centerline, up to 11' AGL/620' MSL.

Trees beginning 1312' from DER, 799' right of centerline, up to 100' AGL/729' MSL.

## JACKSON, AL

### JACKSON MUNI (4R3)

#### TAKEOFF MINIMUMS AND (OBSTACLE) DEPARTURE PROCEDURES

ORIG 03JUN10 (10154) (FAA)

TAKEOFF MINIMUMS:

**Rwy 1**, std. w/ min. climb of 252' per NM to 1000 or 1100-2½ for climb in visual conditions.

**Rwy 19**, 300-1¼ ceiling and visibility to allow see and avoid operation in lieu of required climb gradient for standard minima.

DEPARTURE PROCEDURE:

**Rwy 1**, for climb in visual conditions: cross Jackson Muni airport at or above 1000 MSL before proceeding on course.

TAKEOFF OBSTACLE NOTES:

**Rwy 1**, trees beginning at DER, 400' left/right of centerline, up to 100' AGL/134' MSL.

**Rwy 19**, trees beginning at DER, 400' left/right of centerline, up to 100' AGL/279' MSL.

## JASPER, AL

### WALKER COUNTY/BEVILL FLD (JFX)

#### TAKEOFF MINIMUMS AND (OBSTACLE) DEPARTURE PROCEDURES

AMDT 1 31MAY12 (22027) (FAA)

TAKEOFF MINIMUMS:

**Rwy 27**, 300-1¼ or std. w/min. climb of 259' per NM to 800.

TAKEOFF OBSTACLE NOTES:

**Rwy 9**, trees beginning 614' from DER, 132' left of centerline, up to 95' AGL/574' MSL.

Vehicles on road, pole, and trees beginning 28' from DER, 88' right of centerline, up to 100' AGL/599' MSL.

**Rwy 27**, vehicles on road and trees beginning 7' from DER, 165' left of centerline, up to 95' AGL/572' MSL.

Trees beginning 55' from DER, 24' right of centerline, up to 93' AGL/628' MSL.

Trees 4728' from DER, 1559' right of centerline, up to 80' AGL/639' MSL.

Trees 5615' from DER, 1882' right of centerline, up to 112' AGL/651' MSL.

Trees 5765' from DER, 1882' right of centerline, up to 108' AGL/647' MSL.

## JASPER, GA

### PICKENS COUNTY (JZP)

#### TAKEOFF MINIMUMS AND (OBSTACLE) DEPARTURE PROCEDURES

AMDT 1 25OCT07 (07298) (FAA)

TAKEOFF MINIMUMS:

**Rwy 34**, 300-1 or std. w/ min. climb of 255' per NM to 1800, or alternatively, w/ standard takeoff minimums and a normal

200'/NM climb gradient, takeoff must occur no later than 2100' prior to departure end.

DEPARTURE PROCEDURE:

**Rwy 16**, climb heading 163° to 3000 before turning.

**Rwy 34**, climb heading 343° to 3100 before turning.

TAKEOFF OBSTACLE NOTES:

**Rwy 16**, numerous trees beginning 44' from DER, 338' left of centerline, up to 65' AGL/1565' MSL.

Trees 127' from DER, 398' right of centerline, up to 61' AGL/1581' MSL.

**Rwy 34**, pole and numerous trees beginning 141' from DER, 25' right of centerline, up to 112' AGL/1611' MSL. Numerous trees beginning 394' from DER, 37' left of centerline, up to 79' AGL/1654' MSL.

# TAKEOFF MINIMUMS, (OBSTACLE) DEPARTURE PROCEDURES, AND DIVERSE VECTOR AREA (RADAR VECTORS)

24025

SE-4

# TAKEOFF MINIMUMS, (OBSTACLE) DEPARTURE PROCEDURES, AND DIVERSE VECTOR AREA (RADAR VECTORS)

24025

## JEFFERSON, GA

### JACKSON COUNTY (JCA)

#### TAKEOFF MINIMUMS AND (OBSTACLE) DEPARTURE PROCEDURES

AMDT 3 04FEB16 (16035) (FAA)

##### DEPARTURE PROCEDURE:

**Rwy 17**, climb heading 168° to 1700 before proceeding northwest.

**Rwy 35**, climb heading 348° to 2300 before proceeding west or northwest.

##### TAKEOFF OBSTACLE NOTES:

**Rwy 17**, tank 94' from DER, 490' right of centerline, 12' AGL/956' MSL.

Trees beginning 331' from DER, 296' left of centerline, up to 78' AGL/997' MSL.

Trees 670' from DER, 617' right of centerline, up to 60' AGL/989' MSL.

Trees beginning 1320' from DER, 460' right of centerline, up to 105' AGL/1004' MSL.

**Rwy 35**, trees 13' from DER, 412' right of centerline, up to 31' AGL/950' MSL.

Transmission tower and trees beginning 100' from DER, 464' left of centerline, up to 45' AGL/964' MSL.

Transmission tower and trees beginning 472' from DER, 314' left of centerline, up to 63' AGL/1002' MSL.

Building, transmission tower, poles, and trees beginning 811' from DER, 30' right of centerline, up to 90' AGL/1014' MSL.

Trees beginning 918' from DER, 12' left of centerline, up to 99' AGL/1044' MSL.

Trees beginning 1999' from DER, 19' right of centerline, up to 106' AGL/1047' MSL.

## JEKYLL ISLAND, GA

### JEKYLL ISLAND (09J)

#### TAKEOFF MINIMUMS AND (OBSTACLE) DEPARTURE PROCEDURES

ORIG-A 20JUN19 (19171) (FAA)

##### TAKEOFF MINIMUMS:

**Rwys 18, 36**, NA-Environmental.

##### TAKEOFF OBSTACLE NOTES:

**Rwy 18**, vehicle on road beginning 9' from DER, 411' left of centerline, up to 15' AGL/42' MSL.

Trees 200' from DER, 159' left of centerline, 50' AGL/61' MSL.

## JESUP, GA

### JESUP-WAYNE COUNTY (JES)

#### TAKEOFF MINIMUMS AND (OBSTACLE) DEPARTURE PROCEDURES

ORIG 22OCT09 (09295) (FAA)

##### TAKEOFF OBSTACLE NOTES:

**Rwy 11**, trees beginning 52' from DER, 497' left of centerline, up to 100' AGL/154' MSL.

Trees beginning 312' from DER, 294' right of centerline, up to 100' AGL/154' MSL.

**Rwy 29**, trees beginning 1811' from DER, 181' left of centerline, up to 100' AGL/188' MSL.

Trees beginning 24' from DER, 98' right of centerline, up to 100' AGL/190' MSL.

## LAFAYETTE, GA

### BARWICK LAFAYETTE (9A5)

#### TAKEOFF MINIMUMS AND (OBSTACLE) DEPARTURE PROCEDURES

AMDT 1A 20AUG15 (15232) (FAA)

##### TAKEOFF MINIMUMS:

**Rwy 2**, 300-1½ or std. w/min. climb of 255' per NM to 1100.

**Rwy 20**, 500-3 or std. w/ min. climb of 465' per NM to 1400.

##### DEPARTURE PROCEDURE:

**Rwy 2**, climb heading 022° to 2200 before proceeding on course.

**Rwy 20**, climb heading 202° to 2300 before proceeding on course.

##### TAKEOFF OBSTACLE NOTES:

**Rwy 2**, train on track 39' from DER, 241' left of centerline, 23' AGL/809' MSL.

Building 418' from DER, 191' left of centerline, 40' AGL/849' MSL.

Trees beginning 4420' from DER, 1171' left of centerline, up to 100' AGL/919' MSL.

Trees beginning 5609' from DER, 372' right of centerline, up to 100' AGL/919' MSL.

Trees beginning 12' from DER, 275' left of centerline, up to 83' AGL/879' MSL.

Buildings beginning 302' from DER, 164' left of centerline, up to 40' AGL/813' MSL.

Trees beginning 39' from DER, 432' right of centerline, up to 83' AGL/856' MSL.

Trees, buildings, and windmills beginning 765' from DER, left and right of centerline, up to 131' AGL/988' MSL.

**Rwy 20**, train on track 46' from DER, 323' right of centerline, 23' AGL/809' MSL.

Buildings beginning 1602' from DER, 907' right of centerline, up to 25' AGL/825' MSL.

Vehicle on road 1021' from DER, 104' left of centerline, 15' AGL/802' MSL.

Train on track 762' from DER, on centerline, 23' AGL/803' MSL.

22 FEB 2024 to 21 MAR 2024

22 FEB 2024 to 21 MAR 2024

# TAKEOFF MINIMUMS, (OBSTACLE) DEPARTURE PROCEDURES, AND DIVERSE VECTOR AREA (RADAR VECTORS)

24025

SE-4

# TAKEOFF MINIMUMS, (OBSTACLE) DEPARTURE PROCEDURES, AND DIVERSE VECTOR AREA (RADAR VECTORS)

24025

## LAGRANGE, GA

### LAGRANGE/CALLAWAY (LGC)

#### TAKEOFF MINIMUMS AND (OBSTACLE) DEPARTURE PROCEDURES

AMDT 2 05DEC19 (22027) (FAA)

##### TAKEOFF MINIMUMS:

**Rwy 3**, 300-1½ or std. w/min. climb of 425' per NM to 1000.

**Rwy 21**, 300-1 or std. w/min. climb of 330' per NM to 1000.

**Rwy 31**, 300-1½ or std. w/min. climb of 420' per NM to 900.

##### DEPARTURE PROCEDURE:

**Rwy 31**, climb heading 311° to 1100 before turning south.

##### TAKEOFF OBSTACLE NOTES:

**Rwy 3**, trees beginning 107' from DER, 517' right of centerline, up to 100' AGL/799' MSL.

Trees beginning 217' from DER, 299' left of centerline, up to 100' AGL/819' MSL.

Trees beginning 1694' from DER, crossing extended runway centerline, up to 100' AGL/840' MSL.

Transmission line 3363' from DER, 745' left of centerline, 89' AGL/849' MSL.

Trees beginning 3429' from DER, 836' right of centerline, up to 847' MSL.

Transmission line 3526' from DER, 1441' left of centerline, 101' AGL/864' MSL.

Transmission lines and trees beginning 3528' from DER, 718' left of centerline, up to 105' AGL/881' MSL.

Transmission line and tree beginning 3554' from DER, 909' right of centerline, up to 76' AGL/857' MSL.

Trees beginning 3813' from DER, 204' right of centerline, up to 867' MSL.

Building 1 NM from DER, 1104' right of centerline, 125' AGL/900' MSL.

Buildings beginning 1 NM from DER, 1104' right of centerline, up to 125' AGL/900' MSL.

Tree 1.2 NM from DER, 1226' right of centerline, 919' MSL.

**Rwy 13**, tree at DER, 485' right of centerline, 680' MSL.

Lighting 1' from DER, 5' left of centerline, 2' AGL/677' MSL.

Tree and terrain beginning 5' from DER, 489' right of centerline, up to 717' MSL.

Trees beginning 1071' from DER, 681' left of centerline, up to 733' MSL.

Tree 1735' from DER, 877' right of centerline, 740' MSL.

Tree 1902' from DER, 788' right of centerline, 744' MSL.

Tree 2061' from DER, 935' right of centerline, 748' MSL.

Tree 2343' from DER, 898' right of centerline, 754' MSL.

**Rwy 21**, tree 130' from DER, 384' left of centerline, 720' MSL.

Tree 143' from DER, 487' left of centerline, 753' MSL.

Trees beginning 258' from DER, 244' left of centerline, up to 761' MSL.

Tree 1121' from DER, 532' right of centerline, 735' MSL.

Trees beginning 1182' from DER, 278' right of centerline, up to 751' MSL.

Trees beginning 1814' from DER, 23' right of centerline, up to 805' MSL.

Trees beginning 4175' from DER, 552' left of centerline, up to 848' MSL.

Tree 4273' from DER, 1374' left of centerline, 850' MSL.

Trees beginning 4279' from DER, 326' left of centerline, up to 852' MSL.

Tree 5548' from DER, 1372' right of centerline, 817' MSL.

**Rwy 31**, terrain 59' from DER, 443' right of centerline, 691' MSL.

Tree 192' from DER, 495' right of centerline, 699' MSL.

Trees beginning 919' from DER, 538' right of centerline, up to 756' MSL.

Trees beginning 1220' from DER, 728' left of centerline, up to 778' MSL.

Trees beginning 1222' from DER, 447' right of centerline, up to 757' MSL.

Tree 1295' from DER, 747' right of centerline, 769' MSL.

Trees beginning 1331' from DER, 462' right of centerline, up to 776' MSL.

Trees beginning 1435' from DER, 20' right of centerline, up to 798' MSL.

Trees beginning 1465' from DER, 640' left of centerline, up to 784' MSL.

Trees beginning 1827' from DER, 531' left of centerline, up to 813' MSL.

Trees and pole beginning 2036' from DER, 346' left of centerline, up to 816' MSL.

Trees beginning 2153' from DER, 165' left of centerline, up to 822' MSL.

Trees and pole beginning 2222' from DER, 195' left of centerline, up to 823' MSL.

Trees beginning 2244' from DER, 436' left of centerline, up to 825' MSL.

Trees and pole beginning 2280' from DER, 296' left of centerline, up to 826' MSL.

Trees and poles beginning 2326' from DER, 25' left of centerline, up to 830' MSL.

Trees beginning 2752' from DER, 152' left of centerline, up to 833' MSL.

Tree 2762' from DER, 162' right of centerline, 800' MSL.

Trees beginning 2764' from DER, 65' right of centerline, up to 805' MSL.

Trees beginning 2818' from DER, 241' left of centerline, up to 839' MSL.

Tree 3039' from DER, 946' left of centerline, 842' MSL.

Trees beginning 3049' from DER, 5' left of centerline, up to 847' MSL.

Trees beginning 3065' from DER, 21' right of centerline, up to 814' MSL.

Trees beginning 3896' from DER, 75' right of centerline, up to 824' MSL.

Trees beginning 4236' from DER, 119' right of centerline, up to 826' MSL.

Trees beginning 4318' from DER, 22' right of centerline, up to 831' MSL.

Trees beginning 4461' from DER, 5' left of centerline, up to 859' MSL.

Tree 4604' from DER, 989' right of centerline, 840' MSL.

Trees beginning 4607' from DER, 33' right of centerline, up to 841' MSL.

Trees beginning 5666' from DER, 211' right of centerline, up to 852' MSL.

Trees beginning 5790' from DER, 135' right of centerline, up to 854' MSL.

Tree 1 NM from DER, 544' right of centerline, 855' MSL.

Tree 1 NM from DER, 1009' right of centerline, 858' MSL.

Tree 1 NM from DER, 738' right of centerline, 867' MSL.

CON'T

22 FEB 2024 to 21 MAR 2024

22 FEB 2024 to 21 MAR 2024

# TAKEOFF MINIMUMS, (OBSTACLE) DEPARTURE PROCEDURES, AND DIVERSE VECTOR AREA (RADAR VECTORS)

24025

SE-4



# TAKEOFF MINIMUMS, (OBSTACLE) DEPARTURE PROCEDURES, AND DIVERSE VECTOR AREA (RADAR VECTORS)

24025

## LAGRANGE, GA (CON'T)

### LAGRANGE/CALLAWAY (LGC) (CON'T)

**Rwy 31 (CON'T)**, tree 1 NM from DER, 916' right of centerline, 873' MSL.

Trees beginning 1 NM from DER, 426' right of centerline, up to 891' MSL.

Tree 1 NM from DER, 1190' right of centerline, 859' MSL.

## LANETT, AL

### LANETT RGNL (7A3)

#### TAKEOFF MINIMUMS AND (OBSTACLE) DEPARTURE PROCEDURES

AMDT 1 27JAN22 (22027) (FAA)

##### TAKEOFF MINIMUMS:

**Rwy 6**, 300-1% or std. w/min. climb of 371' per NM to 900.

##### DEPARTURE PROCEDURE:

**Rwy 24**, climb on heading 237° to 1400 before proceeding on course.

##### TAKEOFF OBSTACLE NOTES:

**Rwy 6**, terrain 5' from DER, 494' right of centerline, 641' MSL.

Tree, terrain beginning 26' from DER, 167' right of centerline, up to 695' MSL.

Trees beginning 45' from DER, 237' left of centerline, up to 709' MSL.

Trees beginning 458' from DER, 359' left of centerline, up to 723' MSL.

Tree, building, pole beginning 1007' from DER, 0' on centerline, up to 732' MSL.

Trees beginning 1041' from DER, 263' left of centerline, up to 724' MSL.

Trees beginning 1371' from DER, 14' left of centerline, up to 737' MSL.

Trees beginning 1643' from DER, 37' left of centerline, up to 740' MSL.

Tree, pole beginning 1894' from DER, 2' left of centerline, up to 743' MSL.

Tree, pole beginning 2416' from DER, 60' right of centerline, up to 741' MSL.

Tree, pole beginning 2638' from DER, 36' right of centerline, up to 743' MSL.

Sign, building, pole beginning 3251' from DER, 185' left of centerline, up to 84' AGL/758' MSL.

Pole, tree, traverse, way beginning 3264' from DER, 5' right of centerline, up to 92' AGL/767' MSL.

Pole beginning 3358' from DER, 115' left of centerline, up to 88' AGL/770' MSL.

Pole beginning 3535' from DER, 254' left of centerline, up to 99' AGL/781' MSL.

Pole, tree beginning 3538' from DER, 31' left of centerline, up to 102' AGL/788' MSL.

Pole, tree beginning 3544' from DER, 6' right of centerline, up to 98' AGL/781' MSL.

Water tower, tree beginning 4846' from DER, 1118' right of centerline, up to 101' AGL/788' MSL.

Tower 1.1 NM from DER, 1235' left of centerline, 203' AGL/860' MSL.

**Rwy 24**, tree 28' from DER, 222' left of centerline, 671' MSL.

Trees beginning 87' from DER, 189' right of centerline, up to 683' MSL.

Trees beginning 108' from DER, 331' left of centerline, up to 673' MSL.

Trees beginning 113' from DER, 206' left of centerline, up to 680' MSL.

Tree, terrain beginning 181' from DER, 447' right of centerline, up to 684' MSL.

Trees beginning 786' from DER, 477' right of centerline, up to 691' MSL.

Tree 996' from DER, 739' left of centerline, 687' MSL.

Tree 2493' from DER, 745' left of centerline, 731' MSL.

Trees beginning 2525' from DER, 645' left of centerline, up to 733' MSL.

Tree, pole beginning 3361' from DER, 736' left of centerline, up to 734' MSL.

## LAWRENCEVILLE, GA

### GWINNETT COUNTY/BRISCOE FLD (LZU)

#### TAKEOFF MINIMUMS AND (OBSTACLE) DEPARTURE PROCEDURES

AMDT 6 20OCT11 (21336) (FAA)

##### TAKEOFF MINIMUMS:

**Rwy 25**, 300-1 or std. w/min. climb of 330' per NM to 1400.

##### DEPARTURE PROCEDURE:

**Rwy 7**, climb heading 069° to 2600 before turning left.

##### TAKEOFF OBSTACLE NOTES:

**Rwy 7**, trees beginning 724' from DER, left and right of centerline, up to 110' AGL/1118' MSL.

Rods on floodlights beginning 2619' from DER, 686' right of centerline, up to 143' AGL/11 04' MSL.

**Rwy 25**, vehicle on roadway beginning 1187' from DER, left and right of centerline, up to 15' AGL/1114' MSL.

Poles and antennas beginning 1221' from DER, left and right of centerline, up to 167' AGL/1159' MSL.

Trees beginning 1244' from DER, left and right of centerline, up to 88' AGL/1166' MSL.

Mast 5008' from DER, 1147' left of centerline, 207' AGL/1268' MSL.

Tower 5030' from DER, 1141' left of centerline, 187' AGL/1268' MSL.

# TAKEOFF MINIMUMS, (OBSTACLE) DEPARTURE PROCEDURES, AND DIVERSE VECTOR AREA (RADAR VECTORS)

24025

SE-4

# TAKEOFF MINIMUMS, (OBSTACLE) DEPARTURE PROCEDURES, AND DIVERSE VECTOR AREA (RADAR VECTORS)

24025

## LAWSON AAF (KLSF)

FORT MOORE, GA

TAKEOFF MINIMUMS AND (OBSTACLE) DEPARTURE PROCEDURES

AMDT 1 28DEC23 (23362) (USA)

TAKEOFF MINIMUMS:

**Rwy 15**, std w/min climb of 237'/NM to 700 or 1500-3 for climb in visual conditions.**Rwy 33**, std w/min climb of 250'/NM to 1700 or 1500-3 for climb in visual conditions.

DEPARTURE PROCEDURE:

**Rwy 15**, climb on hdg between 136° CW to 330° from DER.**Rwy 33**, climb on hdg between 150° CW to 010° from DER.

VCOA:

**Rwys 15, 33**, obtain ATC approval for VCOA when requesting IFR clearance. Climb in visual conditions to cross Lawson AAF at or above 1600 before proceeding on course.

TAKEOFF OBSTACLE NOTES:

**Rwy 15**, terrain 6015' from DER, 1849' left of centerline, 408' MSL.**Rwy 33**, terrain 1.8 NM from DER, 3268' left of centerline, 559' MSL.

## LOUISVILLE, GA

LOUISVILLE MUNI (2J3)

TAKEOFF MINIMUMS AND (OBSTACLE) DEPARTURE PROCEDURES

ORIG 17AUG17 (17229) (FAA)

TAKEOFF OBSTACLE NOTES:

**Rwy 13**, trees beginning 103' from DER, 346' left of centerline, up to 325' MSL.

Trees beginning 292' from DER, 467' right of centerline, up to 327' MSL.

Trees beginning 514' from DER, 564' left of centerline, up to 340' MSL.

Trees beginning 1050' from DER, 580' left of centerline, up to 364' MSL.

Trees beginning 1219' from DER, 584' left of centerline, up to 368' MSL.

**Rwy 31**, tree 23' from DER, 438' left of centerline, 338' MSL.

Tree 47' from DER, 358' left of centerline, 339' MSL.

Tree 174' from DER, 480' right of centerline, 375' MSL.

Trees beginning 233' from DER, 240' right of centerline, up to 389' MSL.

Tree 390' from DER, 481' left of centerline, 381' MSL.

Trees beginning 488' from DER, 95' left of centerline, up to 398' MSL.

## LOWE AHP (KLOR)

FORT NOVOSHEL, AL

TAKEOFF MINIMUMS AND (OBSTACLE) DEPARTURE PROCEDURES

ORIG-A 13JUL23 (23194) (USA)

TAKEOFF MINIMUMS:

**Helipads WHISKEY, ECHO, BRAVO**, std. All other helipads, NA.

DEPARTURE PROCEDURE:

**Helipad WHISKEY**, from center of helipad, hover at 274' MSL/30' AGL, then climb heading 183° to 700 before proceeding on course.**Helipad ECHO**, from center of helipad, climb heading 125° to 700 before proceeding on course.**Helipad BRAVO**, from center of helipad, hover at 318' MSL/35' AGL, then climb heading 183° to 700 before proceeding on course.

DIVERSE VECTOR AREA (RADAR VECTORS)

ORIG 13JUL23 (23194) (USA)

Center of Helipads BRAVO, ECHO, and WHISKEY, heading as assigned by ATC.

## MACON, GA

MACON DOWNTOWN (MAC)

TAKEOFF MINIMUMS AND (OBSTACLE) DEPARTURE PROCEDURES

AMDT 8 02MAR17 (17061) (FAA)

DEPARTURE PROCEDURE:

**Rwy 10**, climb heading 102° to 1000 before proceeding on course.

TAKEOFF OBSTACLE NOTES:

**Rwy 10**, trees beginning 89' from DER, 387' right of centerline, up to 460' MSL.

Tree 214' from DER, 393' right of centerline, 466' MSL.

Trees beginning 262' from DER, 346' right of centerline, up to 472' MSL.

Trees beginning 358' from DER, 28' right of centerline, up to 486' MSL.

Tree 3509' from DER, 398' right of centerline, 504' MSL.

Tree 4002' from DER, 529' right of centerline, 514' MSL.

Tree 4003' from DER, 255' right of centerline, 519' MSL.

Tree 4119' from DER, 568' left of centerline, 521' MSL.

Tree 4260' from DER, 298' left of centerline, 527' MSL.

Tree 4454' from DER, 424' left of centerline, 533' MSL.

Tree 4484' from DER, 125' left of centerline, 535' MSL.

Trees beginning 4888' from DER, 205' left of centerline, up to 549' MSL.

Tree 5047' from DER, 4' left of centerline, 557' MSL.

CON'T

# TAKEOFF MINIMUMS, (OBSTACLE) DEPARTURE PROCEDURES, AND DIVERSE VECTOR AREA (RADAR VECTORS)

24025

# TAKEOFF MINIMUMS, (OBSTACLE) DEPARTURE PROCEDURES, AND DIVERSE VECTOR AREA (RADAR VECTORS)

24025

## MACON, GA (CON'T)

### MACON DOWNTOWN (MAC) (CON'T)

**Rwy 28**, trees beginning 133' from DER, 279' left of centerline, up to 443' MSL.

Trees beginning 402' from DER, 35' left of centerline, up to 445' MSL.

Trees beginning 864' from DER, 4' right of centerline, up to 453' MSL.

## MIDDLE GEORGIA RGNL (MCN)

### TAKEOFF MINIMUMS AND (OBSTACLE) DEPARTURE PROCEDURES

AMDT 3C 07SEP23 (23250) (FAA)

#### TAKEOFF MINIMUMS:

**Rwy 5**, std w/min climb of 210' per NM to 1500, or 1000-2½ for climb in visual conditions.

**Rwy 23**, 300-2 or std w/min climb of 211' per NM to 700 or alternatively, with std takeoff minimums and a normal 200' per NM climb gradient, takeoff must occur no later than 1500' prior to DER.

#### VCOA:

**Rwy 5**, obtain ATC approval when requesting IFR clearance. Climb in visual conditions to cross Middle Georgia Rgnl airport at or above 1200 before proceeding on course.

#### TAKEOFF OBSTACLE NOTES:

**Rwy 5**, trees and poles beginning 40' from DER, 59' left of centerline, up to 86' AGL/436' MSL.

Trees, towers, and aircraft equipment beginning 112' from DER, 8' right of centerline, up to 82' AGL/432' MSL.

**Rwy 14**, trees beginning 280' from DER, 279' left of centerline, up to 89' AGL/429' MSL.

Trees beginning 2153' from DER, 136' right of centerline, up to 81' AGL/411' MSL.

**Rwy 23**, trees beginning 69' from DER, left and right of centerline, up to 113' AGL/383' MSL.

Trees beginning 1818' from DER, left and right of centerline, up to 390' MSL.

Trees beginning 2241' from DER, left and right of centerline, up to 405' MSL.

Trees beginning 1.4 NM from DER, 746' left of centerline, up to 572' MSL.

**Rwy 32**, trees beginning 636' from DER, 209' right of centerline, up to 98' AGL/398' MSL.

Trees beginning 925' from DER, 54' left of centerline, up to 90' AGL/440' MSL.

## MADISON, GA

### MADISON MUNI (52A)

#### TAKEOFF MINIMUMS AND (OBSTACLE) DEPARTURE PROCEDURES

ORIG 10MAR11 (11069) (FAA)

#### TAKEOFF OBSTACLE NOTES:

**Rwy 14**, fences beginning abeam DER, 130' left and 269' right of centerline, 9' AGL/703' MSL.

Building abeam DER, 424' right of centerline, 30' AGL/729' MSL.

Vehicles on roadway abeam DER, 212' left of centerline, up to 15' AGL/714' MSL.

Fence 200' from DER, left and right of centerline, 9' AGL/703' MSL.

Vehicles on roadway 210' from DER, left and right of centerline, up to 15' AGL/714' MSL.

Trains beginning 276' from DER, left and right of centerline, up to 23' AGL/722' MSL.

Trees beginning 463' from DER, 468' left of centerline, up to 100' AGL/819' MSL.

Building 643' from DER, 440' left of centerline, 20' AGL/719' MSL.

Trees beginning 752' from DER, 213' right of centerline, up to 100' AGL/799' MSL.

Power lines beginning 1298' from DER, 246' left of centerline, up to 100' AGL/779' MSL.

**Rwy 32**, trees beginning abeam DER, 250' right of centerline, up to 100' AGL/719' MSL.

Trees beginning abeam DER, 300' left of centerline, up to 100' AGL/719' MSL.

Trees beginning 680' from DER, left and right of centerline, up to 100' AGL/719' MSL.

## MARION, AL

### VAIDEN FLD (A08)

#### TAKEOFF MINIMUMS AND (OBSTACLE) DEPARTURE PROCEDURES

ORIG 26JUL12 (22195) (FAA)

#### TAKEOFF OBSTACLE NOTES:

**Rwy 16**, trees beginning 635' from DER, 225' right of centerline, up to 100' AGL/309' MSL.

Trees beginning 2119' from DER, 1057' left of centerline, up to 100' AGL/289' MSL.

**Rwy 34**, trees beginning abeam threshold, 191' left of centerline, up to 100' AGL/349' MSL.

Trees beginning 2128' from DER, 978' right of centerline, up to 100' AGL/349' MSL.

## MAXWELL AFB (KMXF)

### MONTGOMERY, AL

#### TAKEOFF MINIMUMS AND (OBSTACLE) DEPARTURE PROCEDURES

AMDT 5 23FEB23 (23054) (USAF)

#### TAKEOFF MINIMUMS:

**Rwy 15**, std. w/min. climb of 260' per NM to 1300.

#### TAKEOFF OBSTACLE NOTES:

**Rwy 15**, tree canopy approximately 2000' from DER, 600' left and right of centerline, from 67' AGL/197' MSL to 76' AGL/259' MSL.

Pylon 4754' from DER, 1440' left of centerline, 74' AGL/259' MSL.

Pylon 4894' from DER, 1354' left of centerline, 70' AGL/257' MSL.

# TAKEOFF MINIMUMS, (OBSTACLE) DEPARTURE PROCEDURES, AND DIVERSE VECTOR AREA (RADAR VECTORS)

24025

SE-4

22 FEB 2024 to 21 MAR 2024

22 FEB 2024 to 21 MAR 2024

# TAKEOFF MINIMUMS, (OBSTACLE) DEPARTURE PROCEDURES, AND DIVERSE VECTOR AREA (RADAR VECTORS)

24025

## MC RAE, GA

### TELFAIR-WHEELER (MQW)

#### TAKEOFF MINIMUMS AND (OBSTACLE) DEPARTURE PROCEDURES

AMDT 2 08SEP22 (22251) (FAA)

##### TAKEOFF MINIMUMS:

**Rwy 3**, 300-1¼ or std. w/min. climb of 279' per NM to 400.

##### DEPARTURE PROCEDURE:

**Rwy 21**, climb on heading 206 to 700 before proceeding on course.

##### TAKEOFF OBSTACLE NOTES:

**Rwy 3**, vegetation, terrain beginning 137' from DER, 214' right of centerline, up to 223' MSL.

Trees beginning 170' from DER, 10' left of centerline, up to 263' MSL.

Tree, vegetation, terrain beginning 418' from DER, 214' right of centerline, up to 278' MSL.

Trees, vegetation beginning 568' from DER, 89' right of centerline, up to 290' MSL.

Trees, vegetation, pole beginning 828' from DER, 20' right of centerline, up to 293' MSL.

Trees, buildings, poles beginning 1130' from DER, 79' right of centerline, up to 296' MSL.

Tree 1236' from DER, 494' left of centerline, 274' MSL.

Trees, pole, vegetation beginning 1260' from DER, 4' left of centerline, up to 301' MSL.

Trees beginning 1657' from DER, 206' left of centerline, up to 305' MSL.

Trees beginning 1731' from DER, 17' left of centerline, up to 306' MSL.

Trees, grain elevators, building, poles beginning 2127' from DER, 30' right of centerline, up to 299' MSL.

Trees beginning 2789' from DER, 152' right of centerline, up to 301' MSL.

Tree 3375' from DER, 1193' right of centerline, 316' MSL.

Trees, transmission line beginning 3426' from DER, 148' right of centerline, up to 318' MSL.

Trees beginning 3749' from DER, 105' right of centerline, up to 331' MSL.

Trees beginning 3905' from DER, 63' right of centerline, up to 335' MSL.

Trees beginning 3924' from DER, 51' left of centerline, up to 308' MSL.

Trees beginning 4298' from DER, 86' right of centerline, up to 341' MSL.

Trees beginning 4389' from DER, 219' right of centerline, up to 345' MSL.

Tree 5671' from DER, 1907' right of centerline, 349' MSL.

Trees beginning 5886' from DER, 1865' right of centerline, up to 353' MSL.

Tree 6035' from DER, 1992' right of centerline, 355' MSL.

**Rwy 21**, vegetation 3' from DER, 183' left of centerline, 205' MSL.

Vegetation, terrain beginning 11' from DER, 167' right of centerline, up to 210' MSL.

Vegetation 52' from DER, 178' left of centerline, 206' MSL.

Tree, vegetation, vehicle on road beginning 79' from DER, 180' left of centerline, up to 238' MSL.

Trees, vegetation beginning 356' from DER, 19' left of centerline, up to 255' MSL.

Vegetation 364' from DER, 84' right of centerline, 212' MSL.

Tree, vegetation beginning 387' from DER, 47' right of centerline, up to 253' MSL.

Trees, vegetation, vehicle on road beginning 544' from DER, 140' right of centerline, up to 282' MSL.

Trees, pole beginning 978' from DER, 20' left of centerline, up to 260' MSL.

Trees beginning 1182' from DER, 41' right of centerline, up to 288' MSL.

Trees beginning 1230' from DER, 12' left of centerline, up to 266' MSL.

Elevator, trees beginning 1665' from DER, 42' left of centerline, up to 119' AGL/305' MSL.

## METTER, GA

### JOHN EDWIN JONES SR FLD/METTER MUNI (MHP)

#### TAKEOFF MINIMUMS AND (OBSTACLE) DEPARTURE PROCEDURES

ORIG-A 06DEC18 (21280) (FAA)

##### TAKEOFF OBSTACLE NOTES:

**Rwy 10**, tree 30' from DER, 359' left of centerline, 211' MSL.

Tree, sign beginning 48' from DER, 254' left of centerline, up to 217' MSL.

Tree 165' from DER, 223' left of centerline, 224' MSL.

Tree, pole beginning 706' from DER, 206' left of centerline, up to 259' MSL.

Pole 844' from DER, 231' right of centerline, 219' MSL.

Tree, pole beginning 983' from DER, 48' left of centerline, up to 264' MSL.

Pole beginning 1335' from DER, 173' right of centerline, up to 35' AGL/231' MSL.

Tree 1357' from DER, 808' left of centerline, 265' MSL.

Pole beginning 1458' from DER, 77' right of centerline, up to 33' AGL/234' MSL.

Tree, pole beginning 1467' from DER, 91' left of centerline, up to 275' MSL.

Pole 1696' from DER, 123' right of centerline, 38' AGL/245' MSL.

Tree 2406' from DER, 855' right of centerline, 273' MSL.

Sign 3265' from DER, 802' left of centerline, 118' AGL/304' MSL.

**Rwy 28**, trees beginning abeam DER, left and right of centerline, up to 100' AGL/289' MSL.

Vehicles on interstate, abeam DER, 295' right of centerline, up to 17' AGL/196' MSL.

22 FEB 2024 to 21 MAR 2024

22 FEB 2024 to 21 MAR 2024

# TAKEOFF MINIMUMS, (OBSTACLE) DEPARTURE PROCEDURES, AND DIVERSE VECTOR AREA (RADAR VECTORS)

24025

SE-4

# TAKEOFF MINIMUMS, (OBSTACLE) DEPARTURE PROCEDURES, AND DIVERSE VECTOR AREA (RADAR VECTORS)

24025

## MILLEDGEVILLE, GA

### BALDWIN COUNTY RGNL (MLJ)

#### TAKEOFF MINIMUMS AND (OBSTACLE) DEPARTURE PROCEDURES

AMDT 2 25JAN24 (24025) (FAA)

##### TAKEOFF MINIMUMS:

**Rwy 28**, 300-1 or std w/min climb of 335'/NM to 600.

##### TAKEOFF OBSTACLE NOTES:

**Rwy 10**, sign at DER, 199' right of centerline, 3' AGL/360' MSL.

Tree 52' from DER, 489' right of centerline, 424' MSL.

Tree 57' from DER, 512' left of centerline, 421' MSL.

Tree 65' from DER, 387' left of centerline, 438' MSL.

Tree 70' from DER, 321' right of centerline, 435' MSL.

Tree, utility building, transmission line, pole beginning 78' from DER, 68' right of centerline, up to 443' MSL.

Tree, pole beginning 88' from DER, 360' left of centerline, up to 445' MSL.

Tree, building, poles beginning 175' from DER, 292' left of centerline, up to 447' MSL.

Trees beginning 502' from DER, 298' left of centerline, up to 448' MSL.

Trees beginning 569' from DER, 30' left of centerline, up to 457' MSL.

Trees beginning 1901' from DER, 518' left of centerline, up to 461' MSL.

Trees beginning 1917' from DER, 208' left of centerline, up to 105' AGL/464' MSL.

Trees beginning 1948' from DER, 22' left of centerline, up to 468' MSL.

Trees beginning 2187' from DER, 30' right of centerline, up to 444' MSL.

Trees beginning 2446' from DER, 148' right of centerline, up to 448' MSL.

Trees beginning 2647' from DER, 572' right of centerline, up to 449' MSL.

Trees beginning 2653' from DER, 467' right of centerline, up to 459' MSL.

**Rwy 28**, trees, terrain, fence beginning 12' from DER, 313' right of centerline, up to 440' MSL.

Tree 516' from DER, 599' left of centerline, 461' MSL.

Trees beginning 684' from DER, 617' left of centerline, up to 462' MSL.

Trees, terrain, fence, traverse way beginning 737' from DER, 305' right of centerline, up to 503' MSL.

Trees beginning 899' from DER, 594' left of centerline, up to 463' MSL.

Trees beginning 1342' from DER, 522' left of centerline, up to 479' MSL.

Trees beginning 1688' from DER, 677' left of centerline, up to 482' MSL.

Tree, traverse way beginning 1727' from DER, 63' right of centerline, up to 512' MSL.

Trees, pole beginning 1789' from DER, 23' left of centerline, up to 494' MSL.

Trees beginning 2843' from DER, 46' right of centerline, up to 528' MSL.

Tree 3230' from DER, 1106' left of centerline, 498' MSL.

Trees beginning 3254' from DER, 69' left of centerline, up to 506' MSL.

Trees beginning 3444' from DER, 15' right of centerline, up to 534' MSL.

Trees beginning 3503' from DER, 260' left of centerline, up to 508' MSL.

Trees beginning 3547' from DER, 467' left of centerline, up to 514' MSL.

Trees beginning 3621' from DER, 59' left of centerline, up to 521' MSL.

Trees beginning 3680' from DER, 113' right of centerline, up to 535' MSL.

Trees beginning 3795' from DER, 36' right of centerline, up to 539' MSL.

Trees beginning 3823' from DER, 313' right of centerline, up to 543' MSL.

Trees beginning 3883' from DER, 113' left of centerline, up to 536' MSL.

Trees beginning 3963' from DER, 115' right of centerline, up to 548' MSL.

Trees beginning 4003' from DER, 46' left of centerline, up to 540' MSL.

Trees beginning 4319' from DER, 12' right of centerline, up to 550' MSL.

Trees beginning 4667' from DER, 9' right of centerline, up to 540' MSL.

## MILLEN, GA

### MILLEN (2J5)

#### TAKEOFF MINIMUMS AND (OBSTACLE) DEPARTURE PROCEDURES

AMDT 1 20AUG15 (15232) (FAA)

##### TAKEOFF OBSTACLE NOTES:

**Rwy 17**, tree 35' from DER, 377' left of centerline, 92' AGL/292' MSL.

Trees beginning 139' from DER, from 263' left of centerline, up to 100' AGL/307' MSL.

Trees beginning 1864' from DER, from 805' left to 451' right of centerline, up to 100' AGL/331' MSL.

**Rwy 35**, pole 237' from DER, 400' left of centerline, 33' AGL/283' MSL.

Vehicles on road beginning 272' from DER, 331' left of centerline, up to 15' AGL/279' MSL.

Poles, terrain, and building beginning 504' from DER, from 666' left of centerline to 34' right of centerline, up to 34' AGL/299' MSL.

Trees and poles beginning 983' from DER, left and right of centerline, up to 65' AGL/326' MSL.

Elevator and silo 1021' from DER, 760' left of centerline, up to 76' AGL/340' MSL.

# TAKEOFF MINIMUMS, (OBSTACLE) DEPARTURE PROCEDURES, AND DIVERSE VECTOR AREA (RADAR VECTORS)

24025

# TAKEOFF MINIMUMS, (OBSTACLE) DEPARTURE PROCEDURES, AND DIVERSE VECTOR AREA (RADAR VECTORS)

24025

## MOBILE, AL

### MOBILE INTL (BFM)

#### TAKEOFF MINIMUMS AND (OBSTACLE) DEPARTURE PROCEDURES

AMDT 2 05OCT23 (23278) (FAA)

#### TAKEOFF MINIMUMS:

**Rwy 14**, 400-2½ or std w/min climb of 246'/NM to 500.

#### DEPARTURE PROCEDURE:

**Rwy 36**, climb on heading 001° to 900.

#### TAKEOFF OBSTACLE NOTES:

**Rwy 18**, sign 46' from DER, 197' right of centerline, 3' AGL/27' MSL.

Tree 1238' from DER, 815' right of centerline, 94' MSL.

Trees beginning 1442' from DER, 767' right of centerline, up to 105' MSL.

Trees beginning 1494' from DER, 106' right of centerline, up to 107' MSL.

Tree 1821' from DER, 78' left of centerline, 71' MSL.

Trees beginning 1999' from DER, 251' right of centerline, up to 109' MSL.

Trees beginning 2343' from DER, 48' right of centerline, up to 115' MSL.

Tree 2646' from DER, 410' left of centerline, 93' MSL.

Tree 2697' from DER, 493' left of centerline, 96' MSL.

Tree 2743' from DER, 539' left of centerline, 97' MSL.

Tree 2758' from DER, 287' left of centerline, 98' MSL.

Trees beginning 2778' from DER, 102' left of centerline, up to 102' MSL.

Trees beginning 3166' from DER, 256' left of centerline, up to 109' MSL.

Tree 3467' from DER, 794' right of centerline, 116' MSL.

Tree 3772' from DER, 293' left of centerline, 120' MSL.

Tree 3824' from DER, 1086' right of centerline, 122' MSL.

**Rwy 32**, light poles 40' from DER, 124' right of centerline, 3' AGL/28' MSL.

Light poles 40' from DER, 124' left of centerline, 2' AGL/28' MSL.

Trees beginning 750' from DER, 262' right of centerline, up to 69' MSL.

Trees beginning 902' from DER, 94' left of centerline, up to 88' MSL.

Trees beginning 1125' from DER, 509' right of centerline, up to 71' MSL.

Trees beginning 1202' from DER, 191' right of centerline, up to 77' MSL.

Trees beginning 1402' from DER, 11' right of centerline, up to 95' MSL.

Trees beginning 2353' from DER, 271' right of centerline, up to 98' MSL.

Tree 2438' from DER, 149' right of centerline, 99' MSL.

Trees beginning 2503' from DER, 526' right of centerline, up to 103' MSL.

Tree 2533' from DER, 33' right of centerline, 110' MSL.

Tree 2607' from DER, 18' left of centerline, 104' MSL.

Trees beginning 2609' from DER, 21' left of centerline, up to 107' MSL.

Trees beginning 2628' from DER, on centerline, up to 111' MSL.

Sign, trees beginning 2780' from DER, 120' left of centerline, up to 111' AGL/119' MSL.

Trees beginning 2846' from DER, 7' right of centerline, up to 115' MSL.

**Rwy 36**, poles, trees beginning 62' from DER, 209' right of centerline, up to 38' AGL/62' MSL.

Poles beginning 114' from DER, 479' left of centerline, up to 35' AGL/57' MSL.

Poles, trees beginning 1083' from DER, 5' left of centerline, up to 45' AGL/68' MSL.

Trees, pole beginning 1285' from DER, 292' right of centerline, up to 83' MSL.

Trees, pole beginning 1522' from DER, 204' right of centerline, up to 84' MSL.

### MOBILE RGNL (MOB)

#### TAKEOFF MINIMUMS AND (OBSTACLE) DEPARTURE PROCEDURES

AMDT 1A 29MAY14 (14149) (FAA)

#### TAKEOFF OBSTACLE NOTES:

**Rwy 15**, tree 1758' from DER, 886' right of centerline, 79' AGL/270' MSL.

Tree 1987' from DER, 856' left of centerline, 73' AGL/277' MSL.

Tree 2102' from DER, 861' right of centerline, 78' AGL/269' MSL.

Tree 2131' from DER, left of centerline, 76' AGL/280' MSL.

**Rwy 18**, multiple trees beginning 1597' from DER, 15' left of centerline, up to 69' AGL/273' MSL.

Multiple trees beginning 1671' from DER, 207' right of centerline, up to 87' AGL/278' MSL.

**Rwy 36**, multiple trees beginning 1083' from DER, 210' right of centerline, up to 84' AGL/301' MSL.

Multiple trees beginning 532' from DER, 43' left of centerline, up to 73' AGL/287' MSL.

22 FEB 2024 to 21 MAR 2024

22 FEB 2024 to 21 MAR 2024

# TAKEOFF MINIMUMS, (OBSTACLE) DEPARTURE PROCEDURES, AND DIVERSE VECTOR AREA (RADAR VECTORS)

24025

SE-4

# TAKEOFF MINIMUMS, (OBSTACLE) DEPARTURE PROCEDURES, AND DIVERSE VECTOR AREA (RADAR VECTORS)

24025

## MONROE, GA

CY NUNNALLY MEML (D73)

TAKEOFF MINIMUMS AND (OBSTACLE) DEPARTURE PROCEDURES

AMDT 1A 21MAY20 (21168) (FAA)

DEPARTURE PROCEDURE:

**Rwy 3**, climb heading 035° to 1700 before proceeding on course.

TAKEOFF OBSTACLE NOTES:

**Rwy 3**, tree 29' from DER, 358' left of centerline, 910' MSL.  
 Tree 38' from DER, 425' right of centerline, 833' MSL.  
 Trees beginning 135' from DER, 85' left of centerline, up to 913' MSL.  
 Tree 198' from DER, 306' right of centerline, 862' MSL.  
 Transmission lines 200' from DER, 478' right of centerline, 60' AGL/864' MSL.  
 Tree 316' from DER, 544' right of centerline, 874' MSL.  
 Trees beginning 345' from DER, 332' right of centerline, up to 895' MSL.  
 Tree 537' from DER, 552' right of centerline, 902' MSL.  
 Trees beginning 587' from DER, 608' right of centerline, up to 904' MSL.  
 Tree 635' from DER, 587' right of centerline, 907' MSL.  
 Trees, transmission lines and pole beginning 967' from DER, 43' right of centerline, up to 908' MSL.  
 Transmission lines, pole and trees beginning 1899' from DER, 92' right of centerline, up to 110' AGL/928' MSL.  
 Tree 2021' from DER, 393' left of centerline, 915' MSL.  
 Trees and transmission lines beginning 2036' from DER, 101' left of centerline, up to 931' MSL.  
 Trees, transmission lines and pole beginning 2455' from DER, 90' left of centerline, up to 940' MSL.  
 Trees beginning 3116' from DER, 29' right of centerline, up to 931' MSL.  
 Trees and transmission lines beginning 3125' from DER, 148' left of centerline, up to 946' MSL.  
 Transmission lines and trees beginning 3339' from DER, 884' left of centerline, up to 101' AGL/947' MSL.  
 Pole, trees and transmission lines beginning 3348' from DER, 172' left of centerline, up to 100' AGL/948' MSL.  
 Tree and transmission lines beginning 3586' from DER, 94' left of centerline, up to 949' MSL.  
 Transmission lines, pole and trees beginning 3763' from DER, 74' left of centerline, up to 101' AGL/957' MSL.  
**Rwy 21**, terrain 27' from DER, 303' left of centerline, 882' MSL.  
 Transmission lines, terrain and fence beginning 71' from DER, 81' left of centerline, up to 37' AGL/922' MSL.  
 Fence 131' from DER, 215' right of centerline, 2' AGL/879' MSL.  
 Tree 196' from DER, 439' right of centerline, 929' MSL.  
 Tree 266' from DER, 338' right of centerline, 946' MSL.  
 Trees and buildings beginning 291' from DER, 382' right of centerline, up to 956' MSL.  
 Trees and transmission lines beginning 311' from DER, 49' left of centerline, up to 923' MSL.  
 Tree 476' from DER, 417' right of centerline, 957' MSL.  
 Trees, transmission lines and buildings beginning 499' from DER, 72' right of centerline, up to 961' MSL.  
 Transmission lines, trees and buildings beginning 505' from DER, 27' left of centerline, up to 52' AGL/933' MSL.  
 Trees and transmission lines beginning 684' from DER, 176' left of centerline, up to 953' MSL.  
 Trees, transmission lines and buildings beginning 774' from DER, 32' right of centerline, up to 979' MSL.  
 Trees beginning 887' from DER, 256' left of centerline, up to 968' MSL.  
 Trees and transmission lines beginning 948' from DER, 19' left of centerline, up to 970' MSL.

## MONROEVILLE, AL

MONROE COUNTY AEROPLEX (MVC)

TAKEOFF MINIMUMS AND (OBSTACLE) DEPARTURE PROCEDURES

ORIG-A 01FEB18 (18032) (FAA)

TAKEOFF OBSTACLE NOTES:

Trees beginning 1085' from DER, 274' left of centerline, up to 100' AGL/529' MSL.  
 Trees beginning 488' from DER, 291' right of centerline, up to 100' AGL/529' MSL.  
**Rwy 21**, vehicle on road 750' from DER, 661' right of centerline, 15' AGL/434' MSL.  
 Trees abeam DER, 376' right of centerline, up to 56' AGL/475' MSL.  
 Trees beginning 219' from DER, 224' left of centerline, up to 56' AGL/474' MSL.

## MONTEZUMA, GA

DR C P SAVAGE SR (53A)

TAKEOFF MINIMUMS AND (OBSTACLE) DEPARTURE PROCEDURES

AMDT 1 08SEP22 (22251) (FAA)

TAKEOFF OBSTACLE NOTES:

**Rwy 18**, terrain 2' from DER, 198' right of centerline, 338' MSL.  
 Pole 54' from DER, 463' right of centerline, 40' AGL/377' MSL.  
 Terrain beginning 82' from DER, 313' left of centerline, up to 344' MSL.  
 Pole, vehicle on road beginning 496' from DER, 142' right of centerline, up to 46' AGL/383' MSL.  
 Tree 672' from DER, 548' right of centerline, 407' MSL.  
 Tree 792' from DER, 449' left of centerline, 401' MSL.  
 Tree 829' from DER, 625' right of centerline, 416' MSL.  
 Tree, pole, transmission line beginning 877' from DER, 30' left of centerline, up to 420' MSL.  
 Tree, pole beginning 877' from DER, 4' right of centerline, up to 419' MSL.  
 Trees beginning 2521' from DER, 735' right of centerline, up to 427' MSL.  
 Trees beginning 3144' from DER, 402' left of centerline, up to 431' MSL.  
 Trees beginning 3206' from DER, 155' right of centerline, up to 433' MSL.

CON'T

# TAKEOFF MINIMUMS, (OBSTACLE) DEPARTURE PROCEDURES, AND DIVERSE VECTOR AREA (RADAR VECTORS)

24025

# TAKEOFF MINIMUMS, (OBSTACLE) DEPARTURE PROCEDURES, AND DIVERSE VECTOR AREA (RADAR VECTORS)

24025

## MONTEZUMA, GA (CON'T)

### DR C P SAVAGE SR (53A) (CON'T)

**Rwy 36**, tree, terrain, vehicle on road beginning 18' from DER, 127' left of centerline, up to 419' MSL.  
Tree, terrain beginning 53' from DER, 162' right of centerline, up to 427' MSL.  
Tree, terrain beginning 187' from DER, 109' right of centerline, up to 432' MSL.  
Tree, vehicle on road, terrain beginning 256' from DER, 19' left of centerline, up to 437' MSL.  
Tree, terrain beginning 458' from DER, 47' right of centerline, up to 435' MSL.  
Trees beginning 1559' from DER, 13' right of centerline, up to 437' MSL.  
Tree, pole beginning 1865' from DER, 162' right of centerline, up to 448' MSL.  
Tree 2171' from DER, 709' right of centerline, 456' MSL.  
Trees beginning 2219' from DER, 154' right of centerline, up to 475' MSL.  
Tree 2311' from DER, 858' right of centerline, 483' MSL.  
Trees beginning 2342' from DER, 16' right of centerline, up to 493' MSL.  
Trees beginning 3819' from DER, 731' left of centerline, up to 456' MSL.  
Trees beginning 4064' from DER, 1236' left of centerline, up to 460' MSL.

## MONTGOMERY, AL

### MONTGOMERY RGNL (DANNELLY FLD) (MGM)

#### TAKEOFF MINIMUMS AND (OBSTACLE) DEPARTURE PROCEDURES

AMD T 2 26JUL12 (21168) (FAA)

##### DEPARTURE PROCEDURE:

**Rwy 10**, climb heading 097° to 1100 before proceeding on course.

##### TAKEOFF OBSTACLE NOTES:

**Rwy 10**, trees beginning 1493' from DER, 808' right of centerline, up to 90' AGL/276' MSL.  
**Rwy 28**, trees beginning 1523' from DER, left and right of centerline, up to 75' AGL/316' MSL.  
**Rwy 3**, building 272' from DER, 549' left of centerline, 12' AGL/202' MSL.  
Hanger 426' from DER, 557' left of centerline, 20' AGL/210' MSL.  
Hanger 560' from DER, 560' left of centerline, 14' AGL/203' MSL.  
Hangar 670' from DER, 559' left of centerline, 14' AGL/203' MSL.  
Tree 1306' from DER, 318' right of centerline, 56' AGL/245' MSL.  
**Rwy 21**, fence 713' from DER, 295' left of centerline, 11' AGL/241' MSL.  
Tree 1830' from DER, 196' right of centerline, 62' AGL/302' MSL.

## MOODY AFB (KVAD)

### VALDOSTA, GA

#### TAKEOFF MINIMUMS AND (OBSTACLE) DEPARTURE PROCEDURES

AMD T 5 25JAN24 (24025) (USAF)

##### TAKEOFF MINIMUMS:

**Rwy 36L**, 300-1½ or std w/min climb of 254'/NM to 700.  
**Rwy 36R**, 300-1¼ or std w/min climb of 223'/NM to 700 or with std mins and a std 200'/NM climb gradient, takeoff must occur NLT 1700' prior to DER.

##### TAKEOFF OBSTACLE NOTES:

**Rwy 18L**, tree 2729' from DER, 767' left of centerline, 10' AGL/293' MSL.  
**Rwy 18R**, C-130 tail 72' from DER, 466' left of centerline, 38' AGL/248' MSL.  
Tree 2146' from DER, 962' right of centerline, 99' AGL/291' MSL.  
Tree 2644' from DER, 504' right of centerline, 99' AGL/292' MSL.  
Tree 2770' from DER, 281' right of centerline, 99' AGL/292' MSL.  
**Rwy 36L**, C-130 tail 283' from DER, 450' left of centerline, 38' AGL/268' MSL.  
Tree 3207' from DER, 809' left of centerline, 99' AGL/337' MSL.  
Tree 3319' from DER, 517' left of centerline, 99' AGL/337' MSL.  
Terrain 6028' from DER, 1587' right of centerline, 425' MSL.  
Terrain 1.1 NM from DER, 2076' left of centerline, 442' MSL.  
**Rwy 36R**, terrain 1 NM from DER, 200' right of centerline, 120' AGL/409' MSL.

## MOULTRIE, GA

### MOULTRIE MUNI (MGR)

#### TAKEOFF MINIMUMS AND (OBSTACLE) DEPARTURE PROCEDURES

AMD T 3 30JAN20 (20030) (FAA)

##### TAKEOFF OBSTACLE NOTES:

**Rwy 4**, pole abeam DER, 98' right of centerline, 2' AGL/294' MSL.  
Trees, terrain beginning 9' from DER, 262' right of centerline, up to 337' MSL.  
Trees beginning 18' from DER, 250' left of centerline, up to 359' MSL.  
Tree 788' from DER, 701' right of centerline, 359' MSL.  
Trees beginning 2265' from DER, 460' left of centerline, up to 375' MSL.  
Trees beginning 2512' from DER, 637' left of centerline, up to 380' MSL.  
Tree 2740' from DER, 493' left of centerline, 385' MSL.  
Trees beginning 2800' from DER, 34' left of centerline, up to 388' MSL.  
Tree 3217' from DER, 477' right of centerline, 389' MSL.  
Trees beginning 3574' from DER, 511' left of centerline, up to 399' MSL.

CON'T

# TAKEOFF MINIMUMS, (OBSTACLE) DEPARTURE PROCEDURES, AND DIVERSE VECTOR AREA (RADAR VECTORS)

24025

SE-4



# TAKEOFF MINIMUMS, (OBSTACLE) DEPARTURE PROCEDURES, AND DIVERSE VECTOR AREA (RADAR VECTORS)

24025

## MOULTRIE, GA (CON'T)

### MOULTRIE MUNI (MGR) (CON'T)

**Rwy 22**, tree 34' from DER, 324' left of centerline, 321' MSL.

Trees beginning 69' from DER, 317' right of centerline, up to 301' MSL.

Trees beginning 118' from DER, 297' left of centerline, up to 356' MSL.

Trees beginning 190' from DER, 258' right of centerline, up to 308' MSL.

Trees beginning 1178' from DER, 471' left of centerline, up to 358' MSL.

Trees beginning 1299' from DER, 738' left of centerline, up to 361' MSL.

**Rwy 34**, general utility, sign beginning 16' from DER, 114' right of centerline, up to 6' AGL/292' MSL.

Tree 104' from DER, 353' left of centerline, 315' MSL.

Tree 142' from DER, 482' left of centerline, 328' MSL.

Tree 249' from DER, 290' right of centerline, 328' MSL.

Trees beginning 255' from DER, 226' left of centerline, up to 343' MSL.

Trees beginning 447' from DER, 290' right of centerline, up to 340' MSL.

Trees beginning 545' from DER, 304' left of centerline, up to 383' MSL.

Trees beginning 589' from DER, 159' right of centerline, up to 344' MSL.

Trees beginning 761' from DER, 22' left of centerline, up to 391' MSL.

Tree 999' from DER, 379' right of centerline, 370' MSL.

Trees beginning 1010' from DER, 180' right of centerline, up to 377' MSL.

Trees beginning 1159' from DER, 139' right of centerline, up to 379' MSL.

Trees beginning 1288' from DER, 169' right of centerline, up to 387' MSL.

Trees beginning 1382' from DER, 48' right of centerline, up to 391' MSL.

## MUSCLE SHOALS, AL

### NORTHWEST ALABAMA RGNL (MSL)

#### TAKEOFF MINIMUMS AND (OBSTACLE) DEPARTURE PROCEDURES

AMDT 1A 07SEP23 (23250) (FAA)

##### TAKEOFF MINIMUMS:

**Rwy 36**, 300-1/4 or std w/min climb of 239'/NM to 800 or alternatively, with std takeoff minimums and a normal 200'/NM climb gradient, takeoff must occur no later than 1900' prior to DER.

##### DEPARTURE PROCEDURE:

**Rwy 18**, climb on heading 184° to 1400 before proceeding on course.

##### TAKEOFF OBSTACLE NOTES:

**Rwy 18**, tree 90' from DER, 306' left of centerline, 23' AGL/568' MSL.

Trees beginning 42' from DER, 325' right of centerline, up to 98' AGL/617' MSL.

Pole 1550' from DER, 151' left of centerline, 43' AGL/580' MSL.

**Rwy 30**, trees beginning 981' from DER, 184' left of centerline, up to 100' AGL/630' MSL.

Trees beginning 2727' from DER, 322' left of centerline, up to 97' AGL/627' MSL.

Traverse way 31' from DER, 252' right of centerline, 558' MSL.

Pole 839' from DER, 594' left of centerline, 39' AGL/569' MSL.

**Rwy 36**, trees beginning 622' from DER, 89' left of centerline, up to 105' AGL/621' MSL.

Trees beginning 196' from DER, 4' right of centerline, up to 73' AGL/598' MSL.

Poles beginning 499' from DER, 320' left of centerline, up to 39' AGL/575' MSL.

Poles beginning 420' from DER, 26' right of centerline, up to 32' AGL/569' MSL.

Bldg 9' from DER, 437' right of centerline, 21' AGL/557' MSL.

Comm twr 5329' from DER, 469' left of centerline, 161' AGL/698' MSL.

## NAHUNTA, GA

### BRANTLEY COUNTY (4J1)

#### TAKEOFF MINIMUMS AND (OBSTACLE) DEPARTURE PROCEDURES

ORIG 12JAN12 (12012) (FAA)

##### DEPARTURE PROCEDURE:

**Rwy 19**, climb heading 192° to 1500 before turning right.

##### TAKEOFF OBSTACLE NOTES:

**Rwy 1**, vehicles beginning 56' from DER, left and right of centerline, up to 17' AGL/101' MSL.

Trees beginning 1105' from DER, right of centerline, up to 100' AGL/181' MSL.

Transmission towers beginning 768' from DER, 174' right of centerline, up to 32' AGL/112' MSL.

Terrain and trees 85' from DER, 343' right of centerline, 17' AGL/92' MSL.

Trees beginning 25' from DER, 24' left of centerline, up to 100' AGL/165' MSL.

Transmission towers and buildings beginning 15' from DER, 160' left of centerline, up to 43' AGL/118' MSL.

Utility pole 9' from DER, 280' left of centerline, 12' AGL/87' MSL.

**Rwy 19**, vehicle on roadway 29' from DER, 260' left of centerline, 15' AGL/94' MSL.

Trees beginning 1105' from DER, 272' right of centerline, up to 100' AGL/144' MSL.

Rising terrain and trees beginning 274' from DER, 229' right of centerline, up to 21' AGL/96' MSL.

Trees beginning 939' from DER, 26' left of centerline, up to 100' AGL/132' MSL.

Terrain 462' from DER, 581' left of centerline, 17' AGL/92' MSL.

# TAKEOFF MINIMUMS, (OBSTACLE) DEPARTURE PROCEDURES, AND DIVERSE VECTOR AREA (RADAR VECTORS)

24025

# TAKEOFF MINIMUMS, (OBSTACLE) DEPARTURE PROCEDURES, AND DIVERSE VECTOR AREA (RADAR VECTORS)

24025

## NASHVILLE, GA

### BERRIEN COUNTY (4J2)

#### TAKEOFF MINIMUMS AND (OBSTACLE) DEPARTURE PROCEDURES

AMDT 1A 15SEP16 (16259) (FAA)

#### TAKEOFF OBSTACLE NOTES:

**Rwy 10**, tree 94' from DER, 478' left of centerline, 284' MSL.

Trees beginning 179' from DER, 413' right of centerline, up to 274' MSL.

Trees beginning 272' from DER, 461' left of centerline, up to 297' MSL.

Trees beginning 413' from DER, 479' right of centerline, up to 279' MSL.

Trees beginning 887' from DER, 484' right of centerline, up to 283' MSL.

Trees beginning 1060' from DER, 513' right of centerline, up to 305' MSL.

Trees beginning 1491' from DER, 344' right of centerline, up to 318' MSL.

Trees beginning 1674' from DER, 331' right of centerline, up to 320' MSL.

Tree 1698' from DER, 531' right of centerline, 321' MSL.

Trees beginning 1704' from DER, 3' right of centerline, up to 323' MSL.

Tree 1809' from DER, 684' left of centerline, 307' MSL.

Trees beginning 1840' from DER, 32' left of centerline, up to 311' MSL.

Trees beginning 2108' from DER, 73' left of centerline, up to 319' MSL.

Trees beginning 2498' from DER, 32' left of centerline, up to 328' MSL.

Tree 3603' from DER, 185' right of centerline, 325' MSL.

**Rwy 28**, tree 81' from DER, 328' right of centerline, 264' MSL.

Pole and bush beginning 91' from DER, 149' left of centerline, up to 32' AGL/275' MSL.

Stack and pole beginning 610' from DER, 346' left of centerline, up to 40' AGL/286' MSL.

Trees beginning 1209' from DER, 331' right of centerline, up to 316' MSL.

Trees beginning 1345' from DER, 398' left of centerline, up to 308' MSL.

Trees beginning 1582' from DER, 280' left of centerline, up to 315' MSL.

Trees beginning 1733' from DER, 163' left of centerline, up to 318' MSL.

Trees beginning 1805' from DER, 382' right of centerline, up to 329' MSL.

Trees beginning 1954' from DER, 516' right of centerline, up to 335' MSL.

Trees beginning 2725' from DER, 14' right of centerline, up to 337' MSL.

Tree 2897' from DER, 330' left of centerline, 320' MSL.

Trees beginning 2953' from DER, 168' left of centerline, up to 321' MSL.

Trees beginning 3125' from DER, 70' left of centerline, up to 335' MSL.

## ONEONTA, AL

### ROBBINS FLD (20A)

#### TAKEOFF MINIMUMS AND (OBSTACLE) DEPARTURE PROCEDURES

ORIG-B 25APR19 (21336) (FAA)

#### TAKEOFF MINIMUMS:

**Rwy 24**, 300-1¼ or std. w/min. climb of 206' to 1400.

#### DEPARTURE PROCEDURE:

**Rwy 6**, climb heading 058° to 2000 before turning.

**Rwy 24**, climb heading 250° to 2400 before turning.

#### TAKEOFF OBSTACLE NOTES:

**Rwy 6**, trees, beginning 162' from DER, 169' left of centerline, up to 133' AGL/1199' MSL.

Tree 366' from DER, 569' right of centerline, 76' AGL/1169' MSL.

Trees, beginning 3184' from DER, 92' left of centerline, up to 129' AGL/1211' MSL.

Tree 3639' from DER, 86' left of centerline, 147' AGL/1222' MSL.

Tree 4205' from DER, 372' left of centerline, 107' AGL/1231' MSL.

Tree 4499' from DER, 623' left of centerline, 152' AGL/1239' MSL.

**Rwy 24**, tree, traverse way, beginning 145' from DER, 304' left of centerline, up to 135' AGL/1215' MSL

Traverse way 222' from DER, 463' right of centerline, 1147' MSL.

Trees, beginning 255' from DER, 9' left of centerline, up to 137' AGL/1217' MSL.

Tree 281' from DER, 214' right of centerline, 109' AGL/1188' MSL.

Tree 412' from DER, 449' right of centerline, 151' AGL/1230' MSL.

Trees, beginning 736' from DER, 8' right of centerline, up to 157' AGL/1236' MSL.

Tree 5381' from DER, 1917' right of centerline, 60' AGL/1243' MSL.

Tree 1 NM from DER, 1684' right of centerline, 97' AGL/1270' MSL.

22 FEB 2024 to 21 MAR 2024

22 FEB 2024 to 21 MAR 2024

# TAKEOFF MINIMUMS, (OBSTACLE) DEPARTURE PROCEDURES, AND DIVERSE VECTOR AREA (RADAR VECTORS)

24025

SE-4

# TAKEOFF MINIMUMS, (OBSTACLE) DEPARTURE PROCEDURES, AND DIVERSE VECTOR AREA (RADAR VECTORS)

24025

## OZARK, AL

OZARK/BLACKWELL FLD (71J)

TAKEOFF MINIMUMS AND (OBSTACLE) DEPARTURE PROCEDURES

AMDT 2A 19JUL18 (22027) (FAA)

TAKEOFF MINIMUMS:

**Rwy 31**, 300-2 or std. w/min. climb of 203' per NM to 700, or alternatively with std. takeoff minimums and a normal 200' per NM climb gradient, takeoff must occur no later than 1200' prior to DER.

DEPARTURE PROCEDURE:

**Rwy 31**, climb heading 305° to 800 before proceeding on course.

TAKEOFF OBSTACLE NOTES:

**Rwy 13**, trees beginning at DER, 336' left of centerline, up to 86' AGL/404' MSL.

Trees beginning 4' from DER, 83' right of centerline, up to 93' AGL/389' MSL.

Trees beginning 604' from DER, left and right of centerline, up to 100' AGL/437' MSL.

**Rwy 31**, terrain 10' from DER, 319' left of centerline, 370' MSL.

Vehicles on road beginning at DER, 372' left of centerline, up to 15' AGL/404' MSL.

Poles beginning 75' from DER, left and right of centerline, up to 45' AGL/426' MSL.

Tower 151' from DER, 453' left of centerline, 53' AGL/427' MSL.

Trees beginning 189' from DER, 314' left of centerline, up to 39' AGL/409' MSL.

Trees beginning 250' from DER, 216' right of centerline, up to 100' AGL/420' MSL.

Trees beginning 1064' from DER, left and right of centerline, up to 100' AGL/508' MSL.

Tower 1.58 NM from DER, 1588' right of centerline, 168' AGL/600' MSL.

## PELL CITY, AL

ST CLAIR COUNTY (PLR)

TAKEOFF MINIMUMS AND (OBSTACLE) DEPARTURE PROCEDURES

AMDT 3 27APR17 (17117) (FAA)

TAKEOFF MINIMUMS:

**Rwy 21**, 300-1 or std. w/ min. climb of 248' per NM to 700.

DEPARTURE PROCEDURE:

**Rwy 21**, climb heading 206° to 1000 before turning east.

TAKEOFF OBSTACLE NOTES:

**Rwy 3**, tree 60' from DER, 410' left of centerline, 526' MSL.

Trees beginning 194' from DER, 311' left of centerline, up to 567' MSL.

Pole 221' from DER, 548' right of centerline, 27' AGL/508' MSL.

Tree 2647' from DER, 544' right of centerline, 568' MSL.

**Rwy 21**, terrain beginning 30' from DER, 110' right of centerline, up to 493' MSL.

Road, terrain beginning 103' from DER, 238' left of centerline, up to 502' MSL.

Pole, terrain, road beginning 229' from DER, 1' left of centerline, up to 22' AGL/519' MSL.

Road 422' from DER, 139' right of centerline, 501' MSL.

Road 463' from DER, 292' right of centerline, 502' MSL.

Tree, pole beginning 476' from DER, 363' left of centerline, up to 556' MSL.

Trees beginning 497' from DER, 534' right of centerline, up to 525' MSL.

Tree 709' from DER, 555' left of centerline, 567' MSL.

Tree, terrain, pole, building beginning 740' from DER, 231' left of centerline, up to 586' MSL.

Tree, ground, terrain beginning 1197' from DER, 460' left of centerline, up to 595' MSL.

Tree 1534' from DER, 751' right of centerline, 573' MSL.

Tree 3058' from DER, 260' left of centerline, 604' MSL.

Tree 3955' from DER, 198' right of centerline, 583' MSL.

Tree 4183' from DER, 192' right of centerline, 592' MSL.

Tree 4931' from DER, 740' left of centerline, 636' MSL.

## PERRY, GA

PERRY-HOUSTON COUNTY (PXE)

TAKEOFF MINIMUMS AND (OBSTACLE) DEPARTURE PROCEDURES

ORIG 20DEC07 (07354) (FAA)

TAKEOFF MINIMUMS:

**Rwy 36**, std. w/ min. climb of 230' per NM to 1200 or 900-2½ for climb in visual conditions.

DEPARTURE PROCEDURE:

**Rwy 36**, for climb in visual conditions: cross Perry-Houston County Airport at or above 1200 MSL before proceeding on course.

TAKEOFF OBSTACLE NOTES:

**Rwy 18**, vehicles on roadway beginning 30' from DER, 389' right of centerline, up to 15' AGL/414' MSL.

Trees and pylons beginning 133' from DER, 317' right of centerline, up to 72' AGL/461' MSL.

Trees beginning 1127' from DER, 152' left of centerline, up to 100' AGL/519' MSL.

**Rwy 36**, trees left and right of centerline beginning 2806' from DER, up to 100' AGL/529' MSL.

# TAKEOFF MINIMUMS, (OBSTACLE) DEPARTURE PROCEDURES, AND DIVERSE VECTOR AREA (RADAR VECTORS)

24025

# TAKEOFF MINIMUMS, (OBSTACLE) DEPARTURE PROCEDURES, AND DIVERSE VECTOR AREA (RADAR VECTORS)

24025

## PINE MOUNTAIN, GA

### HARRIS COUNTY (PIM)

#### TAKEOFF MINIMUMS AND (OBSTACLE) DEPARTURE PROCEDURES

AMDT 1 18NOV10 (10322) (FAA)

##### TAKEOFF MINIMUMS:

**Rwy 9**, std. w/ min. climb of 233' per NM to 1800 or 1100-2½ for climb in visual conditions.

##### DEPARTURE PROCEDURE:

**Rwy 9**, climbing left turn heading 360° to 2400 before turning east or for climb in visual conditions cross Harris County airport at or above 1900 before proceeding on course.

##### TAKEOFF OBSTACLE NOTES:

**Rwy 9**, terrain and trees beginning at DER, left and right of centerline, up to 100' AGL/1039' MSL.

**Rwy 27**, terrain and trees beginning 55' from DER, left and right of centerline, up to 115' AGL/1015' MSL.

## PRATTVILLE, AL

### PRATTVILLE/GROUBY FLD (1A9)

#### TAKEOFF MINIMUMS AND (OBSTACLE) DEPARTURE PROCEDURES

AMDT 2 20JUN19 (22195) (FAA)

##### TAKEOFF MINIMUMS:

**Rwy 27**, 400-2¼ or std. w/min. climb of 620' per NM to 600.

##### DEPARTURE PROCEDURE:

**Rwy 9**, climb heading 092° to 700 before turning left.

**Rwy 27**, climb heading 272° to 700 before turning right.

##### TAKEOFF OBSTACLE NOTES:

**Rwy 9**, traverse way, lighting beginning 39' from DER, 91' left of centerline, up to 211' MSL.

Trees beginning 352' from DER, 93' left of centerline, up to 235' MSL.

Tree 508' from DER, 634' left of centerline, 269' MSL.

Trees beginning 622' from DER, 563' left of centerline, up to 276' MSL.

Trees beginning 697' from DER, 682' right of centerline, up to 240' MSL.

Trees beginning 1245' from DER, 1' left of centerline, up to 295' MSL.

Trees beginning 1398' from DER, 9' right of centerline, up to 290' MSL.

Trees beginning 2814' from DER, 752' right of centerline, up to 297' MSL.

Trees beginning 3114' from DER, 785' left of centerline, up to 297' MSL.

Trees beginning 3244' from DER, 1037' left of centerline, up to 298' MSL.

Tree 3259' from DER, 1176' left of centerline, 300' MSL.

Trees beginning 3367' from DER, 1037' left of centerline, up to 309' MSL.

Trees beginning 3602' from DER, 1059' left of centerline, up to 313' MSL.

Tree 4210' from DER, 1556' left of centerline, 316' MSL.

Tree 4235' from DER, 1078' left of centerline, 318' MSL.

Trees beginning 4291' from DER, 1063' left of centerline, up to 320' MSL.

**Rwy 27**, vegetation 76' from DER, 184' right of centerline, 228' MSL.

Tree 166' from DER, 516' left of centerline, 292' MSL.

Traverse way 170' from DER, 491' right of centerline, 243' MSL.

Pole 236' from DER, 502' right of centerline, 33' AGL/253' MSL.

Pole, trees beginning 238' from DER, 500' right of centerline, up to 262' MSL.

Tree 353' from DER, 512' left of centerline, 299' MSL.

Tree, poles beginning 561' from DER, 75' left of centerline, up to 328' MSL.

Pole, trees beginning 631' from DER, 505' right of centerline, up to 42' AGL/272' MSL.

Tree, poles beginning 1170' from DER, 115' right of centerline, up to 338' MSL.

Trees beginning 1419' from DER, 303' left of centerline, up to 338' MSL.

Trees beginning 1468' from DER, 7' left of centerline, up to 340' MSL.

Tower, trees beginning 1527' from DER, 11' left of centerline, up to 105' AGL/343' MSL.

Trees beginning 1899' from DER, 30' right of centerline, up to 344' MSL.

Trees beginning 1967' from DER, 32' right of centerline, up to 349' MSL.

Trees beginning 2201' from DER, 72' left of centerline, up to 348' MSL.

Trees beginning 2269' from DER, 71' left of centerline, up to 369' MSL.

Trees beginning 2325' from DER, 81' right of centerline, up to 351' MSL.

Trees beginning 2457' from DER, 2' left of centerline, up to 401' MSL.

Trees beginning 2463' from DER, 388' right of centerline, up to 354' MSL.

CON'T

22 FEB 2024 to 21 MAR 2024

22 FEB 2024 to 21 MAR 2024

# TAKEOFF MINIMUMS, (OBSTACLE) DEPARTURE PROCEDURES, AND DIVERSE VECTOR AREA (RADAR VECTORS)

24025

SE-4

# TAKEOFF MINIMUMS, (OBSTACLE) DEPARTURE PROCEDURES, AND DIVERSE VECTOR AREA (RADAR VECTORS)

24025

## PRATTVILLE, AL (CON'T)

### PRATTVILLE/GROUBY FLD (1A9) (CON'T)

**Rwy 27 (CON'T)**, trees beginning 2510' from DER, 104' right of centerline, up to 359' MSL.

Trees beginning 2570' from DER, 103' right of centerline, up to 361' MSL.

Trees beginning 2731' from DER, 505' right of centerline, up to 362' MSL.

Trees beginning 2807' from DER, 111' right of centerline, up to 363' MSL.

Trees beginning 2959' from DER, 20' right of centerline, up to 384' MSL.

Trees beginning 3177' from DER, 85' right of centerline, up to 399' MSL.

Trees beginning 3291' from DER, 46' right of centerline, up to 408' MSL.

Trees beginning 3528' from DER, 65' left of centerline, up to 412' MSL.

Trees beginning 3552' from DER, 10' right of centerline, up to 411' MSL.

Trees beginning 3943' from DER, 0' of centerline, up to 420' MSL.

Trees beginning 4092' from DER, 3' left of centerline, up to 415' MSL.

Trees beginning 4353' from DER, 8' right of centerline, up to 427' MSL.

Trees beginning 5203' from DER, 34' right of centerline, up to 435' MSL.

Trees beginning 5355' from DER, 322' left of centerline, up to 417' MSL.

Trees beginning 5398' from DER, 1' right of centerline, up to 437' MSL.

Trees beginning 5538' from DER, 120' left of centerline, up to 419' MSL.

Trees beginning 5550' from DER, 7' left of centerline, up to 427' MSL.

Trees beginning 5690' from DER, 795' left of centerline, up to 428' MSL.

Trees beginning 5698' from DER, 196' left of centerline, up to 439' MSL.

Trees beginning 5868' from DER, 15' left of centerline, up to 446' MSL.

Trees beginning 6018' from DER, 200' left of centerline, up to 447' MSL.

Trees beginning 1 NM from DER, 23' left of centerline, up to 466' MSL.

Trees beginning 1 NM from DER, 124' left of centerline, up to 468' MSL.

Tree 1 NM from DER, 295' right of centerline, 448' MSL.

Trees beginning 1 NM from DER, 172' right of centerline, up to 460' MSL.

Trees beginning 1 NM from DER, 537' right of centerline, up to 471' MSL.

Trees beginning 1 NM from DER, 102' left of centerline, up to 476' MSL.

Trees beginning 1 NM from DER, 113' right of centerline, up to 483' MSL.

Trees beginning 1 NM from DER, 5' left of centerline, up to 501' MSL.

Trees beginning 1 NM from DER, 510' right of centerline, up to 496' MSL.

Trees beginning 1 NM from DER, 59' right of centerline, up to 504' MSL.

Tree, building, poles beginning 1 NM from DER, 2' left of centerline, up to 96' AGL/520' MSL.

Trees beginning 1 NM from DER, 32' right of centerline, up to 518' MSL.

Trees beginning 1.1 NM from DER, 133' right of centerline, up to 519' MSL.

Trees beginning 1.2 NM from DER, 25' right of centerline, up to 534' MSL.

Trees beginning 1.2 NM from DER, 83' right of centerline, up to 547' MSL.

Trees beginning 1.2 NM from DER, 50' right of centerline, up to 554' MSL.

Trees beginning 1.2 NM from DER, 151' right of centerline, up to 574' MSL.

Trees beginning 1.2 NM from DER, 20' right of centerline, up to 85' AGL/587' MSL.

Tree, antenna, building, poles beginning 1.3 NM from DER, 66' right of centerline, up to 109' AGL/590' MSL.

Tower, trees beginning 1.5 NM from DER, 466' right of centerline, up to 181' AGL/605' MSL.

Building 1.7 NM from DER, 2935' right of centerline, 33' AGL/515' MSL.

## QUITMAN, GA

### QUITMAN BROOKS COUNTY (4J5)

#### TAKEOFF MINIMUMS AND (OBSTACLE) DEPARTURE PROCEDURES

ORIG 13JAN11 (11013) (FAA)

TAKEOFF MINIMUMS:

**Rwy 10**, std. w/ min. climb of 290' per NM to 1000, or 1000-2½ for climb in visual conditions.

DEPARTURE PROCEDURE:

**Rwy 10**, for climb in visual conditions: cross Quitman Brooks County Airport at or above 1300 before proceeding on course.

**Rwy 28**, climb heading 279° until 700 before turning south.

TAKEOFF OBSTACLE NOTES:

**Rwy 10**, numerous trees beginning 363' from DER, 248' right of centerline, up to 94' AGL/278' MSL.

Multiple utility poles and structures beginning 184' from DER, 146' right of centerline, up to 44' AGL/224' MSL.

**Rwy 28**, numerous trees beginning 496' from DER, 342' right of centerline, up to 79' AGL/250' MSL.

Numerous trees beginning 38' from DER, 219' left of centerline, up to 100' AGL/280' MSL.

22 FEB 2024 to 21 MAR 2024

22 FEB 2024 to 21 MAR 2024

# TAKEOFF MINIMUMS, (OBSTACLE) DEPARTURE PROCEDURES, AND DIVERSE VECTOR AREA (RADAR VECTORS)

24025

SE-4

# TAKEOFF MINIMUMS, (OBSTACLE) DEPARTURE PROCEDURES, AND DIVERSE VECTOR AREA (RADAR VECTORS)

24025

## REDSTONE AAF (KHUA)

REDSTONE ARSENAL, AL

TAKEOFF MINIMUMS AND (OBSTACLE) DEPARTURE PROCEDURES

AMDT 1 05OCT23 (23278) (USA)

TAKEOFF MINIMUMS:

**Rwy 17**, 500-3 or std w/min climb gradient of 240'/NM to 1500.**Rwy 35**, std w/min climb gradient of 240'/NM to 1500.

DEPARTURE PROCEDURE:

**Rwy 17**, climb rwy hdg to 1700 before proceeding on course.**Rwy 35**, climb rwy hdg to 1900 before proceeding on course.

TAKEOFF OBSTACLE NOTES:

**Rwy 17**, trees 2770' from DER, 14' right of centerline, 763' MSL.

Trees 1401' from DER, 861' right of centerline, 729' MSL.

**Rwy 35**, light pole 4169' from DER, 1232' left of centerline, 801' MSL.

Twr 4165' from DER, 1216' left of centerline, 161' AGL/797' MSL.

DIVERSE VECTOR AREA (RADAR VECTORS)

ORIG 05OCT23 (23278) (USA)

**Rwy 17**, required min climb of 390'/NM to 3200.**Rwy 35**, required min climb of 310'/NM to 3400.

## REFORM, AL

NORTH PICKENS (3M8)

TAKEOFF MINIMUMS AND (OBSTACLE) DEPARTURE PROCEDURES

AMDT 1 15DEC11 (11349) (FAA)

TAKEOFF MINIMUMS:

**Rwy 1**, 300-1 or std. w/min. climb of 270' per NM to 500.**Rwy 19**, 500-2 or std. w/min. climb of 499' per NM to 1000.

TAKEOFF OBSTACLE NOTES:

**Rwy 1**, trees beginning at DER, 115' left of centerline, up to 40' AGL/399' MSL.

Trees beginning at DER, 181' right of centerline, up to 40' AGL/280' MSL.

Vehicles on roadway, 1447' from DER, on centerline, up to 15' AGL/275' MSL.

**Rwy 19**, trees beginning at DER, 108' left of centerline, up to 40' AGL/269' MSL.

Trees and terrain beginning 15' from DER, 21' right of centerline, up to 40' AGL/269' MSL.

Towers 1.2 NM from DER, 1851' right of centerline, up to 450' AGL/695' MSL.

## REIDSVILLE, GA

SWINTON SMITH FLD AT REIDSVILLE MUNI (RVJ)

TAKEOFF MINIMUMS AND (OBSTACLE) DEPARTURE PROCEDURES

AMDT 1 26JUL12 (22223) (FAA)

TAKEOFF OBSTACLE NOTES:

**Rwy 11**, trees beginning abeam DER, 500' right of centerline, up to 100' AGL/299' MSL.

Trees beginning 1180' from DER, on centerline, up to 100' AGL/309' MSL.

Power lines beginning 2840' from DER, 1020' left of centerline, up to 100' AGL/319' MSL.

**Rwy 29**, trees beginning abeam DER, left and right of centerline, up to 100' AGL/259' MSL.

Trees beginning 1870' from DER, on centerline, up to 100' AGL/259' MSL.

## ROME, GA

RICHARD B RUSSELL RGNL - J H TOWERS FLD (RMG)

TAKEOFF MINIMUMS AND (OBSTACLE) DEPARTURE PROCEDURES

AMDT 5 20APR23 (23110) (FAA)

TAKEOFF MINIMUMS:

**Rwy 1**, std. w/min. climb of 370' per NM to 2100 or 1400-3 for VCOA.**Rwy 7**, 300-1¼ or std. w/min. climb of 235' per NM to 900, or alternatively, with std. takeoff minimums and a normal 200' per NM climb gradient, takeoff must occur no later than 2000' prior to DER.**Rwy 25**, std. w/min. climb of 380' per NM to 2100 or 1400-3 for VCOA.

DEPARTURE PROCEDURE:

**Rwy 7**, climb on heading 072° to 1600 before proceeding on course.**Rwy 19**, climb on heading 187° to 1400 before proceeding on course.

VCOA:

**Rwys 1, 25**, obtain ATC approval for VCOA when requesting IFR clearance. Climb in visual conditions to cross Richard B Russell Rgnl - J H Towers Fld airport at or above 1900 before proceeding on course.

TAKEOFF OBSTACLE NOTES:

**Rwy 1**, vehicle on roads beginning 9' from DER, 296' left of centerline, up to 635' MSL.

Tree 1552' from DER, 490' left of centerline, 671' MSL.

Tree 1660' from DER, 915' left of centerline, 683' MSL.

Tree 1813' from DER, 919' right of centerline, 685' MSL.

Tree 1948' from DER, 1009' right of centerline, 713' MSL.

Trees beginning 1976' from DER, 888' right of centerline, up to 714' MSL.

Tree 2576' from DER, 1176' left of centerline, 695' MSL.

Tree 3076' from DER, 935' left of centerline, 711' MSL.

Tree 3387' from DER, 810' left of centerline, 716' MSL.

CON'T

# TAKEOFF MINIMUMS, (OBSTACLE) DEPARTURE PROCEDURES, AND DIVERSE VECTOR AREA (RADAR VECTORS)

24025

# TAKEOFF MINIMUMS, (OBSTACLE) DEPARTURE PROCEDURES, AND DIVERSE VECTOR AREA (RADAR VECTORS)

24025

## ROME, GA (CON'T)

### RICHARD B RUSSELL RGNL - J H TOWERS FLD (RMG) (CON'T)

**Rwy 1 (CON'T)**, tree 3615' from DER, 338' right of centerline, 715' MSL.  
 Trees beginning 3630' from DER, 446' right of centerline, up to 723' MSL.  
 Tree 3633' from DER, 43' left of centerline, 718' MSL.  
 Trees beginning 3650' from DER, 249' right of centerline, up to 732' MSL.  
 Tree 3668' from DER, 198' left of centerline, 722' MSL.  
 Tree 3674' from DER, 205' left of centerline, 723' MSL.  
 Tree 3680' from DER, 145' left of centerline, 727' MSL.  
 Tree 3810' from DER, 60' left of centerline, 728' MSL.  
 Trees beginning 3890' from DER, 196' right of centerline, up to 735' MSL.  
 Tree 4265' from DER, 224' left of centerline, 737' MSL.  
 Trees beginning 4381' from DER, 99' left of centerline, up to 741' MSL.  
 Trees beginning 4475' from DER, 188' left of centerline, up to 743' MSL.  
 Tree 4521' from DER, 551' left of centerline, 746' MSL.  
 Tree 4544' from DER, 356' left of centerline, 751' MSL.  
 Tree 4554' from DER, 202' left of centerline, 753' MSL.  
 Trees beginning 4555' from DER, 249' left of centerline, up to 761' MSL.  
 Tree 5135' from DER, 541' left of centerline, 762' MSL.  
**Rwy 7**, trees beginning 14' from DER, 29' right of centerline, up to 160' AGL/764' MSL.  
 Tree 39' from DER, 403' left of centerline, 684' MSL.  
 Trees beginning 118' from DER, 57' left of centerline, up to 160' AGL/771' MSL.  
 Trees beginning 799' from DER, 23' left of centerline, up to 160' AGL/774' MSL.  
 Trees beginning 1485' from DER, 3' right of centerline, up to 160' AGL/769' MSL.  
 Trees beginning 5175' from DER, 925' left of centerline, up to 160' AGL/777' MSL.  
 Trees beginning 5279' from DER, 585' left of centerline, up to 160' AGL/787' MSL.  
 Trees beginning 5581' from DER, 146' right of centerline, up to 160' AGL/789' MSL.  
 Trees beginning 5923' from DER, 223' left of centerline, up to 160' AGL/799' MSL.  
 Tree 1 NM from DER, 694' right of centerline, 160' AGL/799' MSL.  
**Rwy 19**, vegetation 88' from DER, 290' right of centerline, 642' MSL.  
 Vegetation, terrain beginning 94' from DER, 271' right of centerline, up to 643' MSL.  
 Terrain beginning 298' from DER, 341' right of centerline, up to 646' MSL.  
 Fence 313' from DER, 566' right of centerline, 3' AGL/648' MSL.  
 Vegetation, terrain, tree beginning 331' from DER, 359' right of centerline, up to 651' MSL.  
 Tree 440' from DER, 587' left of centerline, 670' MSL.  
 Trees, pole beginning 553' from DER, 307' right of centerline, up to 716' MSL.  
 Tree 636' from DER, 625' left of centerline, 682' MSL.  
 Trees beginning 866' from DER, 680' left of centerline, up to 717' MSL.  
 Trees beginning 1172' from DER, 448' left of centerline, up to 723' MSL.  
 Trees beginning 1779' from DER, 764' right of centerline, up to 719' MSL.  
 Trees beginning 1854' from DER, 65' right of centerline, up to 726' MSL.  
 Trees beginning 1963' from DER, 293' left of centerline, up to 726' MSL.  
 Trees beginning 2864' from DER, 30' left of centerline, up to 737' MSL.  
 Trees beginning 3018' from DER, 13' right of centerline, up to 729' MSL.  
 Trees beginning 3146' from DER, 88' right of centerline, up to 730' MSL.  
 Trees beginning 3158' from DER, 94' right of centerline, up to 731' MSL.  
 Trees beginning 3251' from DER, 656' left of centerline, up to 739' MSL.  
**Rwy 25**, trees, vehicle on road beginning 26' from DER, 8' left of centerline, up to 160' AGL/784' MSL.  
 Trees, vegetation beginning 159' from DER, 47' right of centerline, up to 160' AGL/781' MSL.  
 Trees 1312' from DER, 133' right of centerline, 160' AGL/784' MSL.  
 Trees beginning 1340' from DER, 219' right of centerline, up to 160' AGL/787' MSL.  
 Trees beginning 1576' from DER, 21' right of centerline, up to 160' AGL/790' MSL.  
 Trees beginning 1652' from DER, 65' left of centerline, up to 160' AGL/787' MSL.  
 Trees beginning 1917' from DER, 392' right of centerline, up to 160' AGL/794' MSL.  
 Trees beginning 2049' from DER, 107' right of centerline, up to 160' AGL/797' MSL.  
 Trees beginning 2229' from DER, 177' left of centerline, up to 160' AGL/790' MSL.  
 Trees beginning 2465' from DER, 90' left of centerline, up to 160' AGL/794' MSL.  
 Trees beginning 2701' from DER, 4' left of centerline, up to 160' AGL/800' MSL.  
 Trees beginning 2834' from DER, 81' right of centerline, up to 160' AGL/800' MSL.  
 Trees beginning 3098' from DER, 168' right of centerline, up to 160' AGL/804' MSL.  
 Trees beginning 3334' from DER, 55' right of centerline, up to 160' AGL/807' MSL.  
 Trees beginning 4043' from DER, 228' right of centerline, up to 160' AGL/810' MSL.  
 Trees beginning 4279' from DER, 4' right of centerline, up to 160' AGL/813' MSL.  
 Trees beginning 5528' from DER, 21' left of centerline, up to 160' AGL/807' MSL.  
 Trees 2.1 NM from DER, 3881' right of centerline, 160' AGL/981' MSL.  
 Trees 2.2 NM from DER, 3967' right of centerline, 160' AGL/1023' MSL.  
 Trees beginning 2.3 NM from DER, 3743' right of centerline, up to 160' AGL/1105' MSL.  
 Trees beginning 2.4 NM from DER, 3830' right of centerline, up to 160' AGL/1135' MSL.  
 Trees 2.5 NM from DER, 3916' right of centerline, 160' AGL/1059' MSL.

22 FEB 2024 to 21 MAR 2024

22 FEB 2024 to 21 MAR 2024

# TAKEOFF MINIMUMS, (OBSTACLE) DEPARTURE PROCEDURES, AND DIVERSE VECTOR AREA (RADAR VECTORS)

24025

SE-4

# TAKEOFF MINIMUMS, (OBSTACLE) DEPARTURE PROCEDURES, AND DIVERSE VECTOR AREA (RADAR VECTORS)

24025

## RUSSELLVILLE, AL

BILL PUGH FLD (M22)

TAKEOFF MINIMUMS AND (OBSTACLE) DEPARTURE PROCEDURES

ORIG-A 05MAY11 (21140) (FAA)

TAKEOFF MINIMUMS:

**Rwy 20**, std. w/ min. climb of 451' per NM to 1500, or 400-2 w/ min. climb of 321' per NM to 1600, or 1000-2½ for climb in visual conditions.

DEPARTURE PROCEDURE:

**Rwy 2**, climb heading 018° to 1400 before proceeding on course.

**Rwy 20**, climb heading 198° to 1300 before proceeding on course, or for climb in visual conditions: cross Bill Pugh Fld at or above 1600 before proceeding on course.

TAKEOFF OBSTACLE NOTES:

**Rwy 2**, trees beginning 592' from DER, 200' right of centerline, up to 100' AGL/839' MSL.

Trees beginning 3598' from DER, 283' left of centerline, up to 100' AGL/839' MSL.

**Rwy 20**, trees beginning 1228' from DER, 51' left of centerline, up to 100' AGL/1159' MSL.

Trees beginning 1993' from DER, 380' right of centerline, up to 100' AGL/1159' MSL.

## ST ELMO, AL

ST ELMO (2R5)

TAKEOFF MINIMUMS AND (OBSTACLE) DEPARTURE PROCEDURES

ORIG 14FEB08 (08045) (FAA)

DEPARTURE PROCEDURE:

**Rwy 6**, climb heading 059° to 800 before proceeding on course.

TAKEOFF OBSTACLE NOTES:

**Rwy 6**, trees 1499' from DER, on centerline, 45' AGL/174' MSL.

**Rwy 24**, trees 1730' from DER, 716' left of centerline, 100' AGL/229' MSL.

Trees 1076' from DER, on centerline, 34' AGL/164' MSL.

## SANDERSVILLE, GA

KAOLIN FLD (OKZ)

TAKEOFF MINIMUMS AND (OBSTACLE) DEPARTURE PROCEDURES

AMDT 3 21MAY20 (22195) (FAA)

DEPARTURE PROCEDURE:

**Rwy 13**, climb on heading 125° to 1000 before turning right.

TAKEOFF OBSTACLE NOTES:

**Rwy 13**, tree 42' from DER, 418' left of centerline, 449' MSL.

Trees beginning 97' from DER, 327' left of centerline, up to 465' MSL.

Traverse way 148' from DER, 361' right of centerline, 442' MSL.

Pole 420' from DER, 439' left of centerline, 35' AGL/468' MSL.

Tree 716' from DER, 444' right of centerline, 478' MSL.

Trees, poles beginning 729' from DER, 3' left of centerline, up to 541' MSL.

Tree 1218' from DER, 488' right of centerline, 494' MSL.

Trees beginning 1247' from DER, 7' right of centerline, up to 514' MSL.

Trees beginning 1487' from DER, 265' left of centerline, up to 545' MSL.

Tree 1525' from DER, 619' left of centerline, 549' MSL.

Trees beginning 1602' from DER, 108' left of centerline, up to 565' MSL.

Trees beginning 1727' from DER, 5' left of centerline, up to 570' MSL.

Tree 2956' from DER, 377' right of centerline, 518' MSL.

Tree 3071' from DER, 958' right of centerline, 532' MSL.

Trees beginning 3140' from DER, 578' right of centerline, up to 539' MSL.

Trees beginning 3296' from DER, 576' right of centerline, up to 543' MSL.

Trees beginning 3617' from DER, 363' right of centerline, up to 546' MSL.

Tree 4221' from DER, 780' right of centerline, 547' MSL.

Tree 4233' from DER, 948' right of centerline, 548' MSL.

**Rwy 31**, tree 2' from DER, 144' right of centerline, 408' MSL.

Tree 29' from DER, 144' right of centerline, 410' MSL.

Tree 57' from DER, 147' right of centerline, 413' MSL.

Tree 96' from DER, 494' right of centerline, 427' MSL.

Trees beginning 138' from DER, 415' left of centerline, up to 426' MSL.

Tree 220' from DER, 370' right of centerline, 428' MSL.

Trees beginning 347' from DER, 107' left of centerline, up to 437' MSL.

Trees beginning 398' from DER, 242' right of centerline, up to 442' MSL.

Trees beginning 2049' from DER, 955' right of centerline, up to 485' MSL.

Trees beginning 2449' from DER, 414' right of centerline, up to 511' MSL.

Trees beginning 2535' from DER, 344' right of centerline, up to 512' MSL.

Trees beginning 2620' from DER, 917' right of centerline, up to 527' MSL.

22 FEB 2024 to 21 MAR 2024

22 FEB 2024 to 21 MAR 2024

# TAKEOFF MINIMUMS, (OBSTACLE) DEPARTURE PROCEDURES, AND DIVERSE VECTOR AREA (RADAR VECTORS)

24025

SE-4



# TAKEOFF MINIMUMS, (OBSTACLE) DEPARTURE PROCEDURES, AND DIVERSE VECTOR AREA (RADAR VECTORS)

24025

## SAVANNAH, GA

### SAVANNAH/HILTON HEAD INTL (SAV)

#### TAKEOFF MINIMUMS AND (OBSTACLE) DEPARTURE PROCEDURES

AMDT 7 07DEC17 (17341) (FAA)

##### TAKEOFF MINIMUMS:

**Rwy 10**, 400-2¾ or std. w/min. climb of 205' per NM to 600.

##### DEPARTURE PROCEDURE:

**Rwy 1**, climb heading 6° to 600 before proceeding southwest.

**Rwy 10**, climb heading 097° to 700 before proceeding southwest.

**Rwy 19**, climb heading 186° to 1300 before turning right.

**Rwy 28**, climb heading 277° to 1600 before turning left.

##### TAKEOFF OBSTACLE NOTES:

**Rwy 1**, fence 94' from DER, 503' right of centerline, 7' AGL/47' MSL.

Vehicles on road beginning 98' from DER, 504' right of centerline, up to 54' MSL.

Tower 294' from DER, 416' right of centerline, 24' AGL/63' MSL.

Pole 1336' from DER, 645' right of centerline, 77' MSL.

Tree 2100' from DER, 1040' right of centerline, 97' MSL.

Trees beginning 2208' from DER, 891' right of centerline, up to 113' MSL.

**Rwy 10**, lighting 29' from DER, 152' right of centerline, 4' AGL/47' MSL.

Lighting 29' from DER, 151' left of centerline, 4' AGL/48' MSL.

Tree 200' from DER, 521' right of centerline, 65' MSL.

Tree 743' from DER, 638' left of centerline, 69' MSL.

Tree 1075' from DER, 720' left of centerline, 77' MSL.

Tree 1893' from DER, 930' right of centerline, 99' MSL.

Trees beginning 1979' from DER, 883' right of centerline, up to 118' MSL.

Tree 2299' from DER, 1041' left of centerline, 104' MSL.

Cranes beginning 2.2 NM from DER, 3433' left of centerline, up to 394' AGL/403' MSL.

Cranes beginning 2.3 NM from DER, 2548' left of centerline, up to 394' AGL/404' MSL.

Cranes beginning 2.3 NM from DER, 1650' left of centerline, up to 394' AGL/405' MSL.

**Rwy 19**, tree 865' from DER, 665' right of centerline, 71' MSL.

Trees beginning 1505' from DER, 782' left of centerline, up to 78' MSL.

Tree 1796' from DER, 944' left of centerline, 82' MSL.

**Rwy 28**, lighting 1' from DER, on centerline, 17' MSL.

Sign 3' from DER, 316' left of centerline, 4' AGL/18' MSL.

Tree 1297' from DER, 772' right of centerline, 68' MSL.

Tree 1736' from DER, 775' right of centerline, 75' MSL.

Tree 2331' from DER, 1038' left of centerline, 77' MSL.

Tree 2453' from DER, 912' right of centerline, 91' MSL.

## SCOTTSBORO, AL

### SCOTTSBORO MUNI-WORD FLD (4A6)

#### TAKEOFF MINIMUMS AND (OBSTACLE) DEPARTURE PROCEDURES

AMDT 1 17OCT13 (22195) (FAA)

##### TAKEOFF MINIMUMS:

**Rwy 4**, std. w/min. climb of 302' per NM to 2000 or 1400-2½ for climb in visual conditions.

**Rwy 22**, std. w/min. climb of 400' per NM to 1900 or 1400-2½ for climb in visual conditions.

##### DEPARTURE PROCEDURE:

**Rwy 4**, climb heading 040° to 2000 before proceeding on course or for climb in visual conditions: cross Scottsboro Muni-Word Fld at or above 1900 MSL before proceeding on course.

**Rwy 22**, climb heading 220° to 1900 before proceeding on course or for climb in visual conditions: cross Scottsboro Muni-Word Fld at or above 1900 MSL before proceeding on course.

##### TAKEOFF OBSTACLE NOTES:

**Rwy 4**, pole 409' from DER, 302' left of centerline, 23' AGL/660' MSL.

Terrain beginning 123' from DER, 546' left of centerline, up to 656' MSL.

Terrain beginning 34' from DER, 206' from DER, 206' right of centerline, up to 633' MSL.

**Rwy 22**, terrain beginning 3718' from DER, 1423' left of centerline, up to 751' MSL.

## SELMA, AL

### CRAIG FLD (SEM)

#### TAKEOFF MINIMUMS AND (OBSTACLE) DEPARTURE PROCEDURES

AMDT 2 25OCT07 (22195) (FAA)

##### TAKEOFF OBSTACLE NOTES:

**Rwy 15**, trees beginning 2440' from DER, 231' right of centerline, up to 73' AGL/232' MSL.

Trees beginning 1687' from DER, 568' left of centerline, up to 61' AGL/220' MSL.

**Rwy 33**, tree 1416' from DER, 607' right of centerline, 62' AGL/211' MSL.

Trees beginning 885' from DER, 439' left of centerline, up to 68' AGL/207' MSL.

# TAKEOFF MINIMUMS, (OBSTACLE) DEPARTURE PROCEDURES, AND DIVERSE VECTOR AREA (RADAR VECTORS)

24025

# TAKEOFF MINIMUMS, (OBSTACLE) DEPARTURE PROCEDURES, AND DIVERSE VECTOR AREA (RADAR VECTORS)

24025

## ST SIMONS ISLAND, GA

### ST SIMONS ISLAND (SSI)

#### TAKEOFF MINIMUMS AND (OBSTACLE) DEPARTURE PROCEDURES

AMDT 3A 20JUN19 (19171) (FAA)

#### TAKEOFF OBSTACLE NOTES:

**Rwy 4**, building 53' from DER, 348' right of centerline, 18' AGL/35' MSL.  
 Pole, building beginning 56' from DER, 325' right of centerline, up to 24' AGL/41' MSL.  
 Pole 81' from DER, 373' right of centerline, 39' AGL/56' MSL.  
 Poles beginning 146' from DER, 283' right of centerline, up to 41' AGL/58' MSL.  
 Trees, poles, building beginning 159' from DER, 31' right of centerline, up to 68' MSL.  
 Tree 563' from DER, 292' right of centerline, 74' MSL.  
 Tree 573' from DER, 87' right of centerline, 77' MSL.  
 Trees beginning 574' from DER, 33' right of centerline, up to 79' MSL.  
 Trees beginning 625' from DER, 112' right of centerline, up to 84' MSL.  
 Trees beginning 726' from DER, 75' right of centerline, up to 87' MSL.  
 Trees beginning 810' from DER, 10' right of centerline, up to 91' MSL.  
 Trees beginning 1431' from DER, 26' right of centerline, up to 102' MSL.  
 Trees beginning 2731' from DER, 217' right of centerline, up to 107' MSL.  
 Trees beginning 2944' from DER, 322' right of centerline, up to 109' MSL.  
 Tree 3511' from DER, 1309' right of centerline, 112' MSL.  
 Trees beginning 3518' from DER, 670' right of centerline, up to 113' MSL.  
 Tree 3844' from DER, 335' right of centerline, 114' MSL.  
 Trees, poles beginning 144' from DER, 16' left of centerline, up to 61' MSL.  
 Trees, buildings, poles beginning 410' from DER, 13' left of centerline, up to 83' MSL.  
 Trees, poles beginning 811' from DER, 23' left of centerline, up to 95' MSL.  
 Trees beginning 1623' from DER, 69' left of centerline, up to 99' MSL.  
 Trees beginning 2027' from DER, 38' left of centerline, up to 102' MSL.  
 Trees beginning 2113' from DER, 68' left of centerline, up to 110' MSL.  
 Trees beginning 2624' from DER, 22' left of centerline, up to 116' MSL.  
**Rwy 16**, tree 137' from DER, 388' right of centerline, 55' MSL.  
 Trees, poles, towers, transmission lines beginning 594' from DER, 9' right of centerline, up to 119' MSL.  
 Tower, transmission line beginning 2586' from DER, 19' right of centerline, up to 117' AGL/121' MSL.  
 Trees, poles beginning 63' from DER, 17' left of centerline, up to 78' MSL.  
 Trees, pole beginning 1105' from DER, 26' left of centerline, up to 80' MSL.  
 Trees, transmission lines beginning 1665' from DER, 44' left of centerline, up to 82' MSL.  
**Rwy 22**, tree, pole beginning 45' from DER, 251' right of centerline, up to 75' MSL.  
 Trees beginning 438' from DER, 42' right of centerline, up to 83' MSL.  
 Trees beginning 626' from DER, 32' right of centerline, up to 91' MSL.  
 Trees beginning 1108' from DER, 102' right of centerline, up to 93' MSL.  
 Trees beginning 1367' from DER, 77' right of centerline, up to 98' MSL.  
 Trees beginning 2291' from DER, 129' right of centerline, up to 99' MSL.  
 Pole 3714' from DER, 243' right of centerline, 116' AGL/121' MSL.  
 Pole 3753' from DER, 251' right of centerline, 111' AGL/122' MSL.  
 Trees beginning 15' from DER, 354' left of centerline, up to 82' MSL.  
 Tree 284' from DER, 531' left of centerline, 88' MSL.  
 Tree 335' from DER, 461' left of centerline, 95' MSL.  
 Trees beginning 458' from DER, 34' left of centerline, up to 102' MSL.  
 Trees beginning 580' from DER, 5' left of centerline, up to 111' MSL.  
**Rwy 34**, tree 279' from DER, 463' right of centerline, 44' MSL.  
 Tree 805' from DER, 102' right of centerline, 50' MSL.  
 Trees, building beginning 839' from DER, 161' right of centerline, up to 61' MSL.  
 Poles, tree beginning 1100' from DER, 219' right of centerline, up to 51' AGL/67' MSL.  
 Trees, pole beginning 1239' from DER, 282' right of centerline, up to 83' MSL.  
 Tree 1506' from DER, 610' right of centerline, 86' MSL.  
 Trees beginning 1539' from DER, 45' right of centerline, up to 95' MSL.  
 Trees beginning 2417' from DER, 3' right of centerline, up to 101' MSL.  
 Trees beginning 2880' from DER, 16' right of centerline, up to 109' MSL.  
 Tree 3624' from DER, 1390' right of centerline, 111' MSL.  
 Trees, poles, building beginning 511' from DER, 3' left of centerline, up to 99' MSL.  
 Trees beginning 2194' from DER, 83' left of centerline, up to 100' MSL.  
 Trees beginning 2487' from DER, 17' left of centerline, up to 103' MSL.  
 Trees beginning 2604' from DER, 606' left of centerline, up to 104' MSL.  
 Trees beginning 2655' from DER, 22' left of centerline, up to 109' MSL.  
 Trees beginning 2844' from DER, 139' left of centerline, up to 112' MSL.  
 Trees beginning 3024' from DER, 212' left of centerline, up to 114' MSL.

22 FEB 2024 to 21 MAR 2024

22 FEB 2024 to 21 MAR 2024

# TAKEOFF MINIMUMS, (OBSTACLE) DEPARTURE PROCEDURES, AND DIVERSE VECTOR AREA (RADAR VECTORS)

24025

SE-4

# TAKEOFF MINIMUMS, (OBSTACLE) DEPARTURE PROCEDURES, AND DIVERSE VECTOR AREA (RADAR VECTORS)

24025

## STATESBORO, GA

### STATESBORO-BULLOCH COUNTY (TBR)

#### TAKEOFF MINIMUMS AND (OBSTACLE) DEPARTURE PROCEDURES

ORIG 15JUN23 (23166) (FAA)

#### TAKEOFF OBSTACLE NOTES:

**Rwy 6**, traverse way 24' from DER, 157' right of centerline, 200' MSL.  
Trees beginning 429' from DER, 563' left of centerline, up to 100' AGL/310' MSL.  
Tree 529' from DER, 458' right of centerline, 100' AGL/300' MSL.  
Tree 2495' from DER, 708' right of centerline, 100' AGL/305' MSL.  
Tree 4210' from DER, 1295' right of centerline, 100' AGL/315' MSL.  
**Rwy 14**, traverse way 53' from DER, 409' right of centerline, 159' MSL.  
Traverse way beginning 188' from DER, 456' left of centerline, up to 169' MSL.  
Trees beginning 673' from DER, 480' left of centerline, up to 192' MSL.  
Trees beginning 771' from DER, 534' right of centerline, up to 219' MSL.  
Tree 1085' from DER, 761' left of centerline, 196' MSL.  
Trees beginning 1696' from DER, 498' right of centerline, up to 231' MSL.  
Trees beginning 1869' from DER, 286' right of centerline, up to 233' MSL.  
Trees beginning 1941' from DER, 621' left of centerline, up to 215' MSL.  
Trees beginning 2102' from DER, 883' right of centerline, up to 234' MSL.  
Trees beginning 2177' from DER, 288' left of centerline, up to 216' MSL.  
Tree 2716' from DER, 136' left of centerline, 225' MSL.  
Tree 2736' from DER, 19' left of centerline, 227' MSL.  
Trees beginning 3002' from DER, 141' right of centerline, up to 253' MSL.  
Tree 3321' from DER, 863' right of centerline, 258' MSL.  
Trees beginning 3399' from DER, 1015' right of centerline, up to 259' MSL.  
**Rwy 24**, traverse way beginning 178' from DER, 226' right of centerline, up to 189' MSL.  
Building, traverse way beginning 227' from DER, 236' left of centerline, up to 20' AGL/195' MSL.  
Trees beginning 315' from DER, 315' right of centerline, up to 100' AGL/270' MSL.  
Building, tree beginning 494' from DER, 439' left of centerline, up to 36' AGL/208' MSL.  
Trees beginning 766' from DER, 245' left of centerline, up to 264' MSL.  
Tree, tower beginning 1007' from DER, 200' right of centerline, up to 273' MSL.  
**Rwy 32**, traverse way 6' from DER, 276' left of centerline, 193' MSL.  
Trees beginning 730' from DER, 603' left of centerline, up to 238' MSL.  
Trees beginning 820' from DER, 10' right of centerline, up to 244' MSL.  
Trees beginning 1152' from DER, 20' left of centerline, up to 268' MSL.  
Trees beginning 1782' from DER, 631' right of centerline, up to 248' MSL.  
Trees beginning 1901' from DER, 167' right of centerline, up to 260' MSL.  
Trees beginning 1984' from DER, 468' left of centerline, up to 270' MSL.  
Trees beginning 2039' from DER, 570' right of centerline, up to 271' MSL.  
Trees beginning 2332' from DER, 143' left of centerline, up to 282' MSL.  
Tree 3114' from DER, 1275' right of centerline, 278' MSL.  
Trees beginning 3418' from DER, 309' left of centerline, up to 286' MSL.  
Tree 4254' from DER, 262' right of centerline, 289' MSL.  
Trees beginning 4677' from DER, 36' left of centerline, up to 307' MSL.

## SWAINSBORO, GA

### EAST GEORGIA REGIONAL (SBO)

#### TAKEOFF MINIMUMS AND (OBSTACLE) DEPARTURE PROCEDURES

AMDT 2 26JUL12 (12208) (FAA)

#### TAKEOFF OBSTACLE NOTES:

**Rwy 14**, multiple poles and trees beginning 110' from DER, 53' right of centerline, up to 99' AGL/388' MSL.  
Multiple poles and trees beginning 861' from DER, 45' right of centerline, up to 75' AGL/394' MSL.  
**Rwy 32**, multiple trees beginning 3390' from DER, 29' left of centerline, up to 100' AGL/419' MSL.  
Multiple trees beginning 206' from DER, 210' right of centerline, up to 45' AGL/354' MSL.

## SYLACAUGA, AL

### MERKEL FLD SYLACAUGA MUNI (SCD)

#### TAKEOFF MINIMUMS AND (OBSTACLE) DEPARTURE PROCEDURES

AMDT 3 18SEP14 (22195) (FAA)

#### TAKEOFF MINIMUMS:

**Rwy 9**, 300-1¼ or std. w/min. climb of 308' per NM to 900.  
**Rwy 27**, 200-1¼ or std. w/min. climb of 645' per NM to 800.

#### DEPARTURE PROCEDURE:

**Rwy 9**, climb heading 079° to 2100 before turning right.  
**Rwy 27**, climb heading 259° to 1400 before turning right.

#### TAKEOFF OBSTACLE NOTES:

**Rwy 9**, trees beginning 42' from DER, 261' right of centerline, up to 33' AGL/573' MSL.  
Multiple poles beginning 205' from DER, 340' right of centerline, up to 39' AGL/579' MSL.  
Vehicle on road 446' from DER, 456' right of centerline, 15' AGL/462' MSL.  
Trees beginning 774' from DER, 418' right of centerline, up to 69' AGL/609' MSL.  
Trees beginning 2435' from DER, 313' right of centerline, up to 63' AGL/613' MSL.  
CON'T

# TAKEOFF MINIMUMS, (OBSTACLE) DEPARTURE PROCEDURES, AND DIVERSE VECTOR AREA (RADAR VECTORS)

24025

SE-4

# TAKEOFF MINIMUMS, (OBSTACLE) DEPARTURE PROCEDURES, AND DIVERSE VECTOR AREA (RADAR VECTORS)

24025

## SYLACAUGA, AL (CON'T)

### MERKEL FLD SYLACAUGA MUNI (SCD) (CON'T)

**Rwy 27**, tree 32' from DER, 373' right of centerline, 3' AGL/583' MSL.

Terrain 196' from DER, 400' right of centerline, 585' MSL.

Pole 386' from DER, 592' right of centerline, 42' AGL/622' MSL.

Vehicle on road beginning 425' from DER, 146' right of centerline, up to 15' AGL/618' MSL.

Trees beginning 814' from DER, 93' right of centerline, up to 76' AGL/716' MSL.

Terrain 1058' from DER, 568' right of centerline, 617' MSL.

Trees beginning 4723' from DER, 531' right of centerline, up to 58' AGL/718' MSL.

Trees beginning 18' from DER, 490' left of centerline, up to 36' AGL/616' MSL.

Vehicle on road 84' from DER, 173' left of centerline, up to 15' AGL/581' MSL.

Trees beginning 1070' from DER, 415' left of centerline, up to 81' AGL/621' MSL.

Trees beginning 2309' from DER, 9' left of centerline, up to 66' AGL/646' MSL.

Trees beginning 4059' from DER, 613' left of centerline, up to 77' AGL/737' MSL.

Trees 1.1 NM from DER left and right of centerline, up to 100' AGL/738' MSL.

## SYLVANIA, GA

### PLANTATION AIRPARK (JYL)

#### TAKEOFF MINIMUMS AND (OBSTACLE) DEPARTURE PROCEDURES

AMDT 1 30JAN20 (20030) (FAA)

##### TAKEOFF OBSTACLE NOTES:

**Rwy 5**, traverse way 429' from DER, 323' right of centerline, 202' MSL.

Tree 863' from DER, 467' left of centerline, 215' MSL.

Trees beginning 1149' from DER, 298' right of centerline, up to 232' MSL.

Tree 1216' from DER, 385' left of centerline, 237' MSL.

Tree 1401' from DER, 657' right of centerline, 241' MSL.

Tree 1500' from DER, 736' left of centerline, 243' MSL.

Tree 1566' from DER, 526' right of centerline, 249' MSL.

Tree 1588' from DER, 427' left of centerline, 246' MSL.

Trees beginning 1592' from DER, 576' left of centerline, up to 252' MSL.

Trees beginning 1594' from DER, 392' right of centerline, up to 254' MSL.

Trees beginning 1858' from DER, 518' right of centerline, up to 260' MSL.

Trees beginning 1877' from DER, 552' left of centerline, up to 266' MSL.

Trees beginning 2062' from DER, 454' left of centerline, up to 269' MSL.

Trees beginning 2117' from DER, 450' right of centerline, up to 269' MSL.

Trees beginning 2212' from DER, 103' left of centerline, up to 276' MSL.

Trees beginning 2235' from DER, 15' right of centerline, up to 275' MSL.

Trees beginning 2829' from DER, 37' right of centerline, up to 276' MSL.

Trees beginning 3023' from DER, 40' left of centerline, up to 281' MSL.

Trees beginning 3065' from DER, 170' left of centerline, up to 288' MSL.

Trees beginning 3221' from DER, 116' left of centerline, up to 289' MSL.

**Rwy 15**, wind indicator 68' from DER, 399' left of centerline, 21' AGL/193' MSL.

Trees beginning 94' from DER, 2' left of centerline, up to 100' AGL/171' MSL.

Trees beginning 199' from DER, 11' right of centerline, up to 100' AGL/171' MSL.

Trees beginning 385' from DER, 42' left of centerline, up to 100' AGL/174' MSL.

Trees 530' from DER, 636' left of centerline, 100' AGL/178' MSL.

Tree 618' from DER, 554' left of centerline, 201' MSL.

Trees 635' from DER, 253' left of centerline, 100' AGL/174' MSL.

Tree 769' from DER, 703' left of centerline, 241' MSL.

Trees 780' from DER, 464' left of centerline, 100' AGL/174' MSL.

Tree 869' from DER, 575' left of centerline, 230' MSL.

Trees 885' from DER, 81' left of centerline, 100' AGL/171' MSL.

Trees 926' from DER, 676' left of centerline, 100' AGL/174' MSL.

Tree 1000' from DER, 717' left of centerline, 240' MSL.

Trees 1030' from DER, 292' left of centerline, 100' AGL/171' MSL.

Tree 1106' from DER, 562' left of centerline, 234' MSL.

Trees 1175' from DER, 504' left of centerline, 100' AGL/171' MSL.

Tree 1181' from DER, 748' left of centerline, 241' MSL.

Trees 1280' from DER, 121' left of centerline, 100' AGL/168' MSL.

Tree 1313' from DER, 709' left of centerline, 242' MSL.

Trees beginning 1321' from DER, 28' left of centerline, up to 100' AGL/171' MSL.

**Rwy 23**, trees beginning 30' from DER, 291' left of centerline, up to 239' MSL.

Tree 145' from DER, 308' right of centerline, 178' MSL.

Trees beginning 418' from DER, 364' right of centerline, up to 216' MSL.

Trees beginning 880' from DER, 153' right of centerline, up to 218' MSL.

Tree 2115' from DER, 987' right of centerline, 228' MSL.

Tree 2206' from DER, 464' right of centerline, 231' MSL.

**Rwy 33**, trees beginning 29' from DER, 5' right of centerline, up to 100' AGL/174' MSL.

Trees beginning 70' from DER, 8' left of centerline, up to 100' AGL/171' MSL.

22 FEB 2024 to 21 MAR 2024

22 FEB 2024 to 21 MAR 2024

# TAKEOFF MINIMUMS, (OBSTACLE) DEPARTURE PROCEDURES, AND DIVERSE VECTOR AREA (RADAR VECTORS)

24025

SE-4

# TAKEOFF MINIMUMS, (OBSTACLE) DEPARTURE PROCEDURES, AND DIVERSE VECTOR AREA (RADAR VECTORS)

24025

## TALLADEGA, AL

### TALLADEGA MUNI (ASN)

#### TAKEOFF MINIMUMS AND (OBSTACLE) DEPARTURE PROCEDURES

AMDT 3 27JUN13 (13178) (FAA)

##### TAKEOFF MINIMUMS:

**Rwy 4**, std. w/min. climb of 207' per NM to 1300 or alternatively, with standard takeoff minimums and a normal 200' per NM climb gradient, takeoff must occur no later than 1700' prior to DER or 1400-2½ for climb in visual conditions.

##### DEPARTURE PROCEDURE:

**Rwy 4**, climb heading 038° to 2100 before turning right, or for climb in visual conditions: cross Talladega Muni airport at or above 1800' MSL before proceeding on course. When executing VCOA, notify ATIS prior to departure.

**Rwy 22**, climb heading 233° to 1900 before proceeding on course.

##### TAKEOFF OBSTACLE NOTES:

**Rwy 4**, multiple poles beginning 904' from DER, 418' right of centerline, up to 48' AGL/568' MSL.

Numerous trees beginning 1811' from DER, 48' right of centerline, up to 72' AGL/612' MSL.

Flag pole 3421' from DER, 306' right of centerline, 74' AGL/614' MSL.

Buildings and trees beginning 1319' from DER, 394 left of centerline, up to 89' AGL/629' MSL.

**Rwy 22**, tree 14' from DER, 413' right of centerline, 62' AGL/562' MSL.

Trees beginning 7' from DER, 325' left of centerline, up to 26' AGL/526' MSL

## THOMASTON, GA

### THOMASTON-UPSON COUNTY (OPN)

#### TAKEOFF MINIMUMS AND (OBSTACLE) DEPARTURE PROCEDURES

AMDT 2A 12AUG21 (21224) (FAA)

##### TAKEOFF MINIMUMS:

**Rwy 30**, std. w/min. climb of 268' per NM to 1800, or 1100-3 for VCOA.

##### VCOA:

**Rwy 30**, obtain ATC approval for VCOA when requesting IFR clearance. Climb in visual conditions to cross Thomaston-Upson County airport or above 1700 before proceeding on course.

##### TAKEOFF OBSTACLE NOTES:

**Rwy 12**, tree 2885' from DER, 510' left of centerline, 885' MSL.

Tree 3280' from DER, 1067' left of centerline, 894' MSL.

**Rwy 30**, trees beginning 801' from DER, 444' right of centerline, up to 866' MSL.

Tree 969' from DER, 601' right of centerline, 867' MSL.

Transmission line and catenary beginning 1625' from DER, 274' left of centerline, up to 105' AGL/863' MSL.

## THOMASVILLE, GA

### THOMASVILLE RGNL (TVI)

#### TAKEOFF MINIMUMS AND (OBSTACLE) DEPARTURE PROCEDURES

AMDT 2 22JUN17 (22307) (FAA)

##### TAKEOFF OBSTACLE NOTES:

**Rwy 4**, app light 10' from DER, 9' right of centerline, 2' AGL/231' MSL.

App light 11' from DER, 10' left of centerline, 2' AGL/232' MSL.

Terrain, tree, beginning 53' from DER, 150' right of centerline, up to 237' MSL.

Terrain 518' from DER, 438' left of centerline, 240' MSL.

Terrain 518' from DER, 237' left of centerline, 247' MSL.

Tree, terrain, beginning 570' from DER, 625' left of centerline, up to 269' MSL.

Tree 670' from DER, 577' left of centerline, 281' MSL.

Tree 691' from DER, 645' right of centerline, 281' MSL.

Tree, terrain, beginning 744' from DER, 432' left of centerline, up to 292' MSL.

Tree, pole, beginning 914' from DER, 587' left of centerline, up to 300' MSL.

Tree 2212' from DER, 861' right of centerline, 327' MSL.

Trees, beginning 2344' from DER, 707' right of centerline, up to 354' MSL.

Tree 2632' from DER, 1144' left of centerline, 338' MSL.

Trees, beginning 2645' from DER, 1147' left of centerline, up to 343' MSL.

Trees, beginning 3006' from DER, 857' right of centerline, up to 356' MSL.

**Rwy 14**, app light 10' from DER, 9' right of centerline, 2' AGL/231' MSL.

App light 11' from DER, 10' left of centerline, 2' AGL/232' MSL.

Terrain, tree, beginning 53' from DER, 150' right of centerline, up to 237' MSL.

Terrain 518' from DER, 438' left of centerline, 240' MSL.

Terrain 518' from DER, 237' left of centerline, 247' MSL.

Tree, terrain, beginning 570' from DER, 625' left of centerline, up to 269' MSL.

Tree 670' from DER, 577' left of centerline, 281' MSL.

Tree 691' from DER, 645' right of centerline, 281' MSL.

Tree, terrain, beginning 744' from DER, 432' left of centerline, up to 292' MSL.

Tree, pole, beginning 914' from DER, 587' left of centerline, up to 300' MSL.

Tree 2212' from DER, 861' right of centerline, 327' MSL.

Trees, beginning 2344' from DER, 707' right of centerline, up to 354' MSL.

Tree 2632' from DER, 1144' left of centerline, 338' MSL.

Trees, beginning 2645' from DER, 1147' left of centerline, up to 343' MSL.

Trees, beginning 3006' from DER, 857' right of centerline, up to 356' MSL.

CON'T

22 FEB 2024 to 21 MAR 2024

22 FEB 2024 to 21 MAR 2024

# TAKEOFF MINIMUMS, (OBSTACLE) DEPARTURE PROCEDURES, AND DIVERSE VECTOR AREA (RADAR VECTORS)

24025

SE-4

# TAKEOFF MINIMUMS, (OBSTACLE) DEPARTURE PROCEDURES, AND DIVERSE VECTOR AREA (RADAR VECTORS)

24025

## THOMASVILLE, GA (CON'T) THOMASVILLE RGNL (TVI) (CON'T)

**Rwy 22**, post, ground, beginning 78' from DER, 429' right of centerline, up to 6' AGL/249' MSL.

Tree 79' from DER, 319' left of centerline, 248' MSL.  
Tree 336' from DER, 541' left of centerline, 302' MSL.  
Tree 343' from DER, 542' left of centerline, 304' MSL.  
Tree 445' from DER, 565' right of centerline, 317' MSL.  
Trees, beginning 458' from DER, 562' left of centerline, up to 319' MSL.  
Tree, road, beginning 491' from DER, 84' right of centerline, up to 335' MSL.  
Tree, road, beginning 647' from DER, 73' left of centerline, up to 331' MSL.  
Trees, beginning 827' from DER, 285' left of centerline, up to 337' MSL.  
Trees, beginning 1053' from DER, 53' left of centerline, up to 347' MSL.  
Trees, beginning 1058' from DER, 59' right of centerline, up to 337' MSL.  
Trees, beginning 1248' from DER, 26' right of centerline, up to 340' MSL.  
Trees, beginning 1262' from DER, 131' left of centerline, up to 349' MSL.  
Trees beginning 1372' from DER, 97' left of centerline, up to 351' MSL.  
Trees, beginning 1420' from DER, 101' right of centerline, up to 346' MSL.  
Tree 1671' from DER, 905' right of centerline, 350' MSL.  
Trees, beginning 1672' from DER, 40' right of centerline, up to 351' MSL.  
Tree 1763' from DER, 959' left of centerline, 355' MSL.  
Trees, beginning 1763' from DER, 70' left of centerline, up to 353' MSL.  
Tree 1966' from DER, 662' left of centerline, 355' MSL.  
Trees, beginning 1990' from DER, 89' left of centerline, up to 358' MSL.  
Trees, beginning 2093' from DER, 21' left of centerline, up to 361' MSL.  
Tree 2451' from DER, 490' right of centerline, 353' MSL.  
Trees, beginning 2475' from DER, 42' right of centerline, up to 357' MSL.  
Trees, beginning 2510' from DER, 588' right of centerline, up to 358' MSL.  
Trees, beginning 2592' from DER, 6' right of centerline, up to 364' MSL.  
Tree 4594' from DER, 70' left of centerline, 363' MSL.

**Rwy 32**, tree 177' from DER, 491' left of centerline, 317' MSL.  
Trees, beginning 483' from DER, 537' right of centerline, up to 335' MSL.  
Tree 768' from DER, 603' left of centerline, 331' MSL.  
Trees, beginning 817' from DER, 157' left of centerline, up to 335' MSL.  
Tree 1064' from DER, 640' right of centerline, 337' MSL.  
Trees, beginning 1089' from DER, 55' right of centerline, up to 339' MSL.  
Tree 1622' from DER, 775' left of centerline, 337' MSL.  
Trees, beginning 1629' from DER, 78' left of centerline, up to 342' MSL.  
Trees, beginning 2461' from DER, 6' right of centerline, up to 342' MSL.  
Tree 3069' from DER, 232' right of centerline, 343' MSL.  
Trees, beginning 3253' from DER, 144' left of centerline, up to 351' MSL.  
Trees, beginning 3333' from DER, 208' right of centerline, up to 361' MSL.  
Trees, beginning 4595' from DER, 72' left of centerline, up to 364' MSL.

## THOMSON, GA THOMSON-MCDUFFIE COUNTY (HQU) TAKEOFF MINIMUMS AND (OBSTACLE) DEPARTURE PROCEDURES AMDT 2 15SEP16 (22167) (FAA)

TAKEOFF OBSTACLE NOTES:

**Rwy 10**, t-l twr 178' from DER, 455' left of centerline, 35' AGL/529' MSL.  
Tree, t-l twr beginning 382' from DER, 48' left of centerline, up to 592' MSL.  
T-l twr 669' from DER, 623' right of centerline, 33' AGL/524' MSL.  
T-l twrs beginning 686' from DER, 415' right of centerline, up to 35' AGL/531' MSL.  
T-l twr 730' from DER, 626' right of centerline, 40' AGL/532' MSL.  
Pole 999' from DER, 618' right of centerline, 60' AGL/553' MSL.  
Pole, bldg beginning 1001' from DER, 539' right of centerline, up to 556' MSL.  
T-l twr 1984' from DER, 333' right of centerline, 91' AGL/580' MSL.  
T-l twr 2005' from DER, 428' right of centerline, 99' AGL/588' MSL.  
Pole, t-l twr beginning 2127' from DER, 942' right of centerline, up to 589' MSL.  
**Rwy 28**, tree 200' from DER, 547' left of centerline, 477' MSL.  
Tree 425' from DER, 521' left of centerline, 479' MSL.  
Trees beginning 453' from DER, 537' right of centerline, up to 514' MSL.  
Tree 757' from DER, 654' left of centerline, 503' MSL.  
Trees beginning 3899' from DER, 1121' left of centerline, up to 562' MSL.  
Tree 4902' from DER, 1248' left of centerline, 578' MSL.  
Trees beginning 4902' from DER, 1180' left of centerline, up to 578' MSL.

22 FEB 2024 to 21 MAR 2024

22 FEB 2024 to 21 MAR 2024

# TAKEOFF MINIMUMS, (OBSTACLE) DEPARTURE PROCEDURES, AND DIVERSE VECTOR AREA (RADAR VECTORS)

24025

SE-4

# TAKEOFF MINIMUMS, (OBSTACLE) DEPARTURE PROCEDURES, AND DIVERSE VECTOR AREA (RADAR VECTORS)

24025

## TIFTON, GA

### HENRY TIFT MYERS (TMA)

#### TAKEOFF MINIMUMS AND (OBSTACLE) DEPARTURE PROCEDURES

AMDT 6A 17AUG17 (17229) (FAA)

##### TAKEOFF MINIMUMS:

**Rwy 34**, 400-2¼ or std. with a min. climb of 360' per NM to 900.

##### DEPARTURE PROCEDURE:

**Rwy 28**, climb heading 277° to 1200 before turning right.

**Rwy 34**, climb heading 332° to 900 before turning left.

##### TAKEOFF OBSTACLE NOTES:

**Rwy 10**, tree 167' from DER, 491' right of centerline, 377' MSL.

Trees beginning 208' from DER, 308' left of centerline, up to 390' MSL.

Trees beginning 618' from DER, 525' left of centerline, up to 403' MSL.

Tree 791' from DER, 623' right of centerline, 384' MSL.

Tree 840' from DER, 569' right of centerline, 393' MSL.

Trees beginning 1274' from DER, 611' left of centerline, up to 413' MSL.

Tree 1788' from DER, 788' left of centerline, 416' MSL.

Trees beginning 1876' from DER, 660' left of centerline, up to 423' MSL.

Trees beginning 1968' from DER, 161' right of centerline, up to 427' MSL.

Tree 2402' from DER, 704' left of centerline, 428' MSL.

**Rwy 16**, tree and runway light beginning 6' from DER, 60' right of centerline, up to 54' AGL/377' MSL.

Runway light 11' from DER, 59' left of centerline, 2' AGL/340' MSL.

Tree 293' from DER, 565' right of centerline, 378' MSL.

Tree and pole beginning 298' from DER, 441' right of centerline, up to 379' MSL.

Tree 565' from DER, 647' left of centerline, 371' MSL.

Trees beginning 567' from DER, 520' left of centerline, up to 376' MSL.

Tree 603' from DER, 635' right of centerline, 414' MSL.

Trees beginning 604' from DER, 421' right of centerline, up to 417' MSL.

Trees beginning 972' from DER, 532' left of centerline, up to 380' MSL.

Tree 2947' from DER, 572' right of centerline, 419' MSL.

Trees beginning 2951' from DER, 470' right of centerline, up to 428' MSL.

**Rwy 28**, tree 78' from DER, 287' right of centerline, 385' MSL.

Trees beginning 139' from DER, 272' right of centerline, up to 392' MSL.

Trees beginning 1074' from DER, 289' left of centerline, up to 410' MSL.

Tree 1206' from DER, 558' left of centerline, 416' MSL.

Trees beginning 1244' from DER, 24' left of centerline, up to 419' MSL.

Tree 1281' from DER, 178' right of centerline, 403' MSL.

Tree 1295' from DER, 223' right of centerline, 415' MSL.

Trees beginning 1295' from DER, 88' right of centerline, up to 417' MSL.

Trees beginning 1316' from DER, 456' left of centerline, up to 420' MSL.

Trees beginning 1323' from DER, 296' left of centerline, up to 421' MSL.

Trees beginning 1368' from DER, 154' left of centerline, up to 427' MSL.

Tree and pole beginning 1409' from DER, 7' left of centerline, up to 430' MSL.

Trees beginning 1445' from DER, 76' right of centerline, up to 421' MSL.

Trees beginning 1480' from DER, 209' right of centerline, up to 425' MSL.

Trees beginning 1537' from DER, 260' right of centerline, up to 426' MSL.

Trees beginning 1555' from DER, 124' right of centerline, up to 429' MSL.

Trees beginning 1625' from DER, 86' right of centerline, up to 430' MSL.

Trees beginning 1676' from DER, on centerline, up to 434' MSL.

Tree and pole beginning 1754' from DER, 34' right of centerline, up to 437' MSL.

Tree 1898' from DER, 625' right of centerline, 92' AGL/439' MSL.

Trees beginning 1899' from DER, 23' right of centerline, up to 441' MSL.

Trees beginning 1929' from DER, 13' left of centerline, up to 433' MSL.

Trees beginning 2743' from DER, 79' left of centerline, up to 434' MSL.

Trees beginning 3117' from DER, 297' right of centerline, up to 450' MSL.

Trees beginning 3452' from DER, 1116' right of centerline, up to 96' AGL/451' MSL.

**Rwy 34**, trees beginning 9' from DER, 150' right of centerline, up to 358' MSL.

Tree 76' from DER, 457' left of centerline, 57' AGL/398' MSL.

Tree and pole beginning 178' from DER, 389' left of centerline, up to 405' MSL.

Tree and pole beginning 282' from DER, 337' left of centerline, up to 428' MSL.

Tree 667' from DER, 642' right of centerline, 416' MSL.

Trees beginning 713' from DER, 510' right of centerline, up to 431' MSL.

Trees beginning 832' from DER, 291' right of centerline, up to 436' MSL.

Tree 2018' from DER, 964' left of centerline, 434' MSL.

Trees beginning 2021' from DER, 618' left of centerline, up to 438' MSL.

Trees beginning 2504' from DER, 890' left of centerline, up to 440' MSL.

Tree 2584' from DER, 1173' left of centerline, 443' MSL.

Trees beginning 2586' from DER, 132' left of centerline, up to 451' MSL.

Trees beginning 2814' from DER, 938' right of centerline, up to 439' MSL.

Tree 2932' from DER, 1033' right of centerline, 440' MSL.

Trees beginning 2933' from DER, 841' right of centerline, up to 443' MSL.

Trees beginning 3250' from DER, 393' right of centerline, up to 450' MSL.

Tower 5755' from DER, 1324' right of centerline, 155' AGL/523' MSL.

Tower 1.2 NM from DER, 273' right of centerline, 190' AGL/569' MSL.

Tower and antenna beginning 1.5 NM from DER, 789' left of centerline, up to 349' AGL/688' MSL.

Tower 1.9 NM from DER, 816' left of centerline, 292' AGL/652' MSL.

22 FEB 2024 to 21 MAR 2024

22 FEB 2024 to 21 MAR 2024

# TAKEOFF MINIMUMS, (OBSTACLE) DEPARTURE PROCEDURES, AND DIVERSE VECTOR AREA (RADAR VECTORS)

24025

SE-4

# TAKEOFF MINIMUMS, (OBSTACLE) DEPARTURE PROCEDURES, AND DIVERSE VECTOR AREA (RADAR VECTORS)

24025

## TOCCOA, GA

### TOCCOA RG LETOURNEAU FLD (TOC)

#### TAKEOFF MINIMUMS AND (OBSTACLE) DEPARTURE PROCEDURES

AMDT 3A 10DEC15 (22223) (FAA)

##### TAKEOFF MINIMUMS:

**Rwy 3**, std. w/min. climb of 430' per NM to 2600 or 1600-3 for VCOA.

**Rwy 27**, std. w/min. climb of 478' per NM to 2500 or 1600-3 for VCOA.

##### DEPARTURE PROCEDURE:

**Rwy 9**, climb heading 094° to 2000 before turning on course.

**Rwy 21**, climb heading 207° to 2200 before turning on course.

##### VCOA:

**Rwys 3, 27**, obtain ATC approval for VCOA when requesting IFR clearance. Climb in visual conditions to cross Toccoa RG Letourneau Fld airport at or above 2600 MSL, before proceeding on course.

##### TAKEOFF OBSTACLE NOTES:

**Rwy 3**, tree 142' from DER, 458' right of centerline, 57' AGL/1,032' MSL, scattered trees 71' from DER, 271' right of centerline, 57' AGL/989' MSL.

**Rwy 9**, terrain 99' from DER, 177' right of centerline, 975' MSL.

Terrain 108' from DER, 126' left of centerline, 955' MSL.

**Rwy 21**, terrain 29' from DER, 208' right of centerline 1023' MSL.

Tower 376' from DER, 520' left of centerline up to 39' AGL/1008' MSL.

Multiple trees 589' from DER, 196' right of centerline, up to 66' AGL/1120' MSL.

Multiple trees 553' from DER, 62' left of centerline, up to 89' AGL/1107' MSL.

**Rwy 27**, tower 1.2 NM from DER, 1818' left of centerline, 354' AGL/1364' MSL.

## TROY, AL

### TROY MUNI AT N KENNETH CAMPBELL FLD (TOI)

#### TAKEOFF MINIMUMS AND (OBSTACLE) DEPARTURE PROCEDURES

AMDT 6 29MAY14 (22195) (FAA)

##### TAKEOFF MINIMUMS:

**Rwy 14**, std. w/min. climb of 280' per NM to 1200 or 1600-2½ for climb in visual conditions.

**Rwy 32**, std. w/min. climb of 281' per NM to 3200 or 1600-2½ for climb in visual conditions.

##### DEPARTURE PROCEDURE:

**Rwy 7**, climb heading 073° to 1000 before turning left.

**Rwy 14**, climb heading 147° to 1200 before turning right, for climb in visual conditions: cross Troy Muni at N Kenneth Campbell Fld at or above 1800 MSL before proceeding on course. When executing VCOA, notify ATC prior to departure.

**Rwy 25**, climb heading 254° to 1700 before turning right.

**Rwy 32**, for climb in visual conditions: cross Troy Muni at N Kenneth Campbell Fld at or above 1800 MSL before proceeding on course. When executing VCOA, notify ATC prior to departure.

##### TAKEOFF OBSTACLE NOTES:

**Rwy 7**, sign 38' from DER, 425' right of centerline, 23' AGL/413' MSL.

Trees beginning 297' from DER, 339' left of centerline, up to 80' AGL/471' MSL.

Trees beginning 802' from DER, 455' right of centerline, up to 65' AGL/449' MSL.

Trees beginning 1846' from DER, 363' left of centerline, up to 100' AGL/519' MSL.

**Rwy 14**, trees beginning 52' from DER, 338' left of centerline, up to 66' AGL/431' MSL.

Trees beginning 305' from DER, 330' right of centerline, up to 60' AGL/425' MSL.

Trees beginning 548' from DER, 84' left of centerline, up to 100' AGL/465' MSL.

Trees beginning 1176' from DER, 32' right of centerline, up to 95' AGL/449' MSL.

Pole and trees beginning 1.1 NM from DER, left and right of centerline, up to 100' AGL/606' MSL.

**Rwy 25**, trees beginning 31' from DER, 476' left of centerline, up to 100' AGL/447' MSL.

Trees beginning 119' from DER, 420' right of centerline, up to 45' AGL/414' MSL.

Trees beginning 1485' from DER, 761' right of centerline, up to 80' AGL/523' MSL.

Tree 4066' from DER, 1355' left of centerline, 100' AGL/519' MSL.

**Rwy 32**, terrain and brush beginning 148' from DER, left and right of centerline, up to 12' AGL/427' MSL.

Terrain, brush, and trees beginning 673' from DER, left and right of centerline, up to 65' AGL/505' MSL.

Pole, brush, and trees beginning 1979' from DER, left and right of centerline, up to 100' AGL/549' MSL.

22 FEB 2024 to 21 MAR 2024

22 FEB 2024 to 21 MAR 2024

# TAKEOFF MINIMUMS, (OBSTACLE) DEPARTURE PROCEDURES, AND DIVERSE VECTOR AREA (RADAR VECTORS)

24025

SE-4



# TAKEOFF MINIMUMS, (OBSTACLE) DEPARTURE PROCEDURES, AND DIVERSE VECTOR AREA (RADAR VECTORS)

24025

## TUSCALOOSA, AL

### TUSCALOOSA NTL (TCL)

#### TAKEOFF MINIMUMS AND (OBSTACLE) DEPARTURE PROCEDURES

AMDT 3 08SEP22 (22251) (FAA)

#### TAKEOFF MINIMUMS:

**Rwy 4**, 300-1¼ or std. w/min. climb of 256' per NM to 600.

**Rwy 12**, 400-2½ w/min. climb of 210' per NM to 800, or std. w/min. climb of 217' per NM to 600, or 1000-3 for VCOA.

**Rwy 30**, 400-2½ or std. w/min. climb gradient of 235' per NM to 500.

#### VCOA:

**Rwy 12**, obtain ATC approval for VCOA when requesting IFR clearance. Climb in visual conditions to cross Tuscaloosa NTL airport at or above 900 before proceeding on course.

#### TAKEOFF OBSTACLE NOTES:

**Rwy 4**, trees beginning 1061' from DER, 400' right of centerline, up to 197' MSL.

Trees beginning 1206' from DER, 172' right of centerline, up to 201' MSL.

Trees beginning 1298' from DER, 52' right of centerline, up to 204' MSL.

Tree 1527' from DER, 97' right and 474' left of centerline up to 226' MSL.

Trees beginning 1548' from DER, 140' left, 116' right of centerline, up to 235' MSL.

Trees beginning 1932' from DER, 5' left, 146' right of centerline, up to 239' MSL.

Trees beginning 2296' from DER, 25' left, 6' right of centerline, up to 247' MSL.

Tree 3193' from DER, 275' left of centerline, 252' MSL.

Trees beginning 3265' from DER, 33' left, 54' right of centerline, up to 263' MSL.

Tree 4525' from DER, 428' left of centerline, 279' MSL.

Tree 4586' from DER, 585' left of centerline, 280' MSL.

Trees beginning 4640' from DER, 220' left of centerline, up to 287' MSL.

Trees beginning 4666' from DER, 34' right of centerline, up to 289' MSL.

Trees beginning 4752' from DER, 133' left of centerline, up to 296' MSL.

Trees beginning 4810' from DER, 5' right, 129' left of centerline, up to 300' MSL.

Trees beginning 5149' from DER, 297' left of centerline, up to 302' MSL.

Trees beginning 5282' from DER, 530' left of centerline, up to 312' MSL.

Trees beginning 5641' from DER, 485' left of centerline, up to 316' MSL.

Tree 5860' from DER, 618' left of centerline, 318' MSL.

Tree 5901' from DER, 349' left of centerline, 319' MSL.

Trees beginning 5999' from DER, 291' left of centerline, up to 330' MSL.

Tree 1.1 NM from DER, 2189' left of centerline, 347' MSL.

Tree 1.1 NM from DER, 2235' left of centerline, 369' MSL.

Tree 1.2 NM from DER, 2265' left of centerline, 379' MSL.

Tree 1.3 NM from DER, 2236' left of centerline, 409' MSL.

Tree 1.3 NM from DER, 2296' left of centerline, 419' MSL.

Trees beginning 1.3 NM from DER, 2456' left of centerline, up to 429' MSL.

Tree 1.4 NM from DER, 2391' left of centerline, 439' MSL.

Tree 1.5 NM from DER, 526' left of centerline, 409' MSL.

**Rwy 12**, tree, beginning 304' from DER, 9' right of centerline, up to 100' AGL/261' MSL.

Tree 574' from DER, 565' left of centerline, 197' MSL.

Tree 839' from DER, 62' left of centerline, 203' MSL.

Tree, beginning 1114' from DER, 138' left of centerline, up to 216' MSL.

Trees beginning 1309' from DER, 8' left of centerline, up to 100' AGL/235' MSL.

Tree 2906' from DER, 1076' left of centerline, 100' AGL/242' MSL.

Tree 3134' from DER, 1190' left of centerline, 100' AGL/245' MSL.

Tower 2 NM from DER, 1177' left of centerline, 239' AGL/494' MSL.

**Rwy 22**, tree 422' from DER, 588' left of centerline, 177' MSL.

Tree 1611' from DER, 601' left of centerline, 203' MSL.

**Rwy 30**, trees, vehicle on roadway beginning 9' from DER, 49' right of centerline, up to 264' MSL.

Pole 685' from DER, 385' left of centerline, 53' AGL/213' MSL.

Trees beginning 777' from DER, 169' left of centerline, up to 219' MSL.

Trees beginning 957' from DER, 187' left of centerline, up to 224' MSL.

Trees beginning 1393' from DER, 71' left of centerline, up to 259' MSL.

Trees 2320' from DER, 927' left of centerline, 269' MSL.

Tower 3961' from DER, 1118' left of centerline, 139' AGL/301' MSL.

## TUSKEGEE, AL

### MOTON FLD MUNI (06A)

#### TAKEOFF MINIMUMS AND (OBSTACLE) DEPARTURE PROCEDURES

ORIG 09APR09 (22195) (FAA)

#### TAKEOFF OBSTACLE NOTES:

**Rwy 13**, trees beginning 5' from DER, 295' right of centerline, up to 100' AGL/389' MSL.

Trees beginning 6' from DER, 304' left of centerline, up to 100' AGL/359' MSL.

**Rwy 31**, trees beginning 12' from DER, 219' right of centerline, up to 100' AGL/359' MSL.

Vehicle 464' from DER, 601' left of centerline, up to 15' AGL/284' MSL.

Trees beginning 929' from DER, 568' left of centerline, up to 100' AGL/369' MSL.

# TAKEOFF MINIMUMS, (OBSTACLE) DEPARTURE PROCEDURES, AND DIVERSE VECTOR AREA (RADAR VECTORS)

24025

# TAKEOFF MINIMUMS, (OBSTACLE) DEPARTURE PROCEDURES, AND DIVERSE VECTOR AREA (RADAR VECTORS)

24025

## VALDOSTA, GA

### VALDOSTA RGNL (VLD)

#### TAKEOFF MINIMUMS AND (OBSTACLE) DEPARTURE PROCEDURES

AMDT 2A 25JAN24 (24025) (FAA)

##### TAKEOFF OBSTACLE NOTES:

- Rwy 4**, tree 57' from DER, 361' right of centerline, 200' MSL.  
Trees beginning 151' from DER, 8' right of centerline, up to 100' AGL/294' MSL.  
Tree 1523' from DER, 899' left of centerline, 254' MSL.  
Trees beginning 1686' from DER, 26' left of centerline, up to 100' AGL/274' MSL.  
Trees beginning 1864' from DER, 92' left of centerline, up to 274' MSL.  
Tree 3406' from DER, 1268' left of centerline, 100' AGL/284' MSL.  
Tree 3652' from DER, 1445' left of centerline, 100' AGL/291' MSL.  
Tree 3805' from DER, 1233' left of centerline, 100' AGL/294' MSL.
- Rwy 18**, tree 861' from DER, 667' left of centerline, 248' MSL.  
Trees beginning 1454' from DER, 561' left of centerline, up to 251' MSL.  
Trees beginning 2020' from DER, 298' left of centerline, up to 286' MSL.  
Tree 3310' from DER, 487' left of centerline, 289' MSL.  
Tree 3743' from DER, 454' right of centerline, 301' MSL.
- Rwy 22**, tree 69' from DER, 348' left of centerline, 237' MSL.  
Tree 74' from DER, 505' right of centerline, 250' MSL.  
Tree 81' from DER, 126' left of centerline, 100' AGL/297' MSL.  
Tree 142' from DER, 475' right of centerline, 100' AGL/294' MSL.  
Trees beginning 174' from DER, 21' left of centerline, up to 100' AGL/301' MSL.  
Trees, vehicles on road beginning 235' from DER, 86' right of centerline, up to 100' AGL/297' MSL.  
Trees beginning 940' from DER, 13' right of centerline, up to 100' AGL/301' MSL.  
Tree 2689' from DER, 897' right of centerline, 100' AGL/314' MSL.  
Trees beginning 2781' from DER, 117' right of centerline, up to 100' AGL/317' MSL.  
Trees beginning 2935' from DER, 10' right of centerline, up to 100' AGL/320' MSL.  
Trees beginning 2967' from DER, 271' left of centerline, up to 100' AGL/304' MSL.  
Trees beginning 3120' from DER, 24' left of centerline, up to 100' AGL/320' MSL.
- Rwy 36**, trees beginning 1654' from DER, 246' right of centerline, up to 254' MSL.  
Trees beginning 1669' from DER, 135' left of centerline, up to 251' MSL.  
Tree 2059' from DER, 757' right of centerline, 256' MSL.  
Trees beginning 2290' from DER, 449' left of centerline, up to 267' MSL.

#### DIVERSE VECTOR AREA (RADAR VECTORS)

AMDT 1 08DEC16 (16343) (FAA)

**Rwys 4, 13, 17, 22, 35**, heading as assigned by ATC.**Rwy 31**, heading as assigned by ATC; requires min. climb of 230' per NM to 700.

## VERNON, AL

### LAMAR COUNTY (M55)

#### TAKEOFF MINIMUMS AND (OBSTACLE) DEPARTURE PROCEDURES

AMDT 2 23SEP10 (10266) (FAA)

##### TAKEOFF MINIMUMS:

**Rwy 17**, 300-1.

##### TAKEOFF OBSTACLE NOTES:

- Rwy 17**, vehicle 2255' from DER, 72' left of centerline, 15' AGL/515' MSL.  
Trees beginning 382' from DER, 110' right of centerline, up to 100' AGL/579' MSL.  
Trees beginning 181' from DER, 168' left of centerline, up to 100' AGL/596' MSL.
- Rwy 35**, trees beginning 26' from DER, 235' left of centerline, up to 100' AGL/559' MSL.  
Trees beginning 305' from DER, 328' right of centerline, up to 100' AGL/559' MSL.

## VIDALIA, GA

### VIDALIA RGNL (VDI)

#### TAKEOFF MINIMUMS AND (OBSTACLE) DEPARTURE PROCEDURES

AMDT 2 20AUG15 (15232) (FAA)

##### TAKEOFF MINIMUMS:

**Rwy 32**, 300-1½ or std. w/min. climb of 225' per NM to 500, or alternatively, with standard takeoff minimums and a normal 200' per NM climb gradient, takeoff must occur no later than 1600' prior to DER.

##### TAKEOFF OBSTACLE NOTES:

- Rwy 7**, sign 32' from DER, 75' left of centerline, 1' AGL/270' MSL.  
Trees beginning 324' from DER, 574' left of centerline, up to 75' AGL/305' MSL.  
Trees beginning 969' from DER, 706' right of centerline, up to 85' AGL/325' MSL.  
Tree 3121' from DER, 936' left of centerline, 118' AGL/348' MSL.
- Rwy 14**, trees beginning 14' from DER, 228' right of centerline, up to 73' AGL/333' MSL.  
Trees beginning 29' from DER, 328' left of centerline, up to 80' AGL/342' MSL.  
Trees beginning 1258' from DER, left and right of centerline, up to 102' AGL/338' MSL.
- Rwy 25**, REILS 8' from DER, 90' left and right of centerline, 1' AGL/274' MSL.  
Trees beginning 8' from DER, 262' right of centerline, up to 85' AGL/355' MSL.  
Terrain 24' from DER, 331' right of centerline, 280' MSL.  
Trees beginning 88' from DER, 284' left of centerline, up to 99' AGL/339' MSL.

CON'T

# TAKEOFF MINIMUMS, (OBSTACLE) DEPARTURE PROCEDURES, AND DIVERSE VECTOR AREA (RADAR VECTORS)

24025

# TAKEOFF MINIMUMS, (OBSTACLE) DEPARTURE PROCEDURES, AND DIVERSE VECTOR AREA (RADAR VECTORS)

24025

## VIDALIA, GA (CON'T)

### VIDALIA RGNL (VDI) (CON'T)

**Rwy 32**, trees beginning 4' from DER, 271' left of centerline, up to 105' AGL/345' MSL.  
Trees beginning 57' from DER, 318' right of centerline, up to 82' AGL/338' MSL.  
Trees beginning 1157' from DER, left and right of centerline, up to 103' AGL/357' MSL.  
Water tower 5411' from DER, 1012' right of centerline, 134' AGL/424' MSL.

## WASHINGTON, GA

### WASHINGTON/WILKES COUNTY (I1Y)

#### TAKEOFF MINIMUMS AND (OBSTACLE) DEPARTURE PROCEDURES

AMDT 1 27JAN22 (22027) (FAA)

##### TAKEOFF OBSTACLE NOTES:

**Rwy 13**, terrain 9' from DER, 130' right of centerline, 634' MSL.  
Tree, pole beginning 191' from DER, 5' right of centerline, up to 700' MSL.  
Tree 193' from DER, 170' left of centerline, 648' MSL.  
Tree 195' from DER, 267' left of centerline, 652' MSL.  
Trees beginning 339' from DER, 80' left of centerline, up to 695' MSL.  
Trees beginning 844' from DER, 503' left of centerline, up to 699' MSL.  
Tree 891' from DER, 397' left of centerline, 705' MSL.  
Trees beginning 951' from DER, 13' left of centerline, up to 707' MSL.  
Trees beginning 2131' from DER, 330' right of centerline, up to 709' MSL.  
Trees beginning 2387' from DER, 564' right of centerline, up to 715' MSL.  
**Rwy 31**, tree 7' from DER, 452' right of centerline, 691' MSL.  
Terrain 29' from DER, 216' left of centerline, 650' MSL.  
Vehicle on road 140' from DER, 338' left of centerline, 666' MSL.  
Tree, vehicle on road beginning 158' from DER, 353' left of centerline, up to 751' MSL.  
Tree 190' from DER, 448' right of centerline, 702' MSL.  
Tree, pole, vehicle on road, elevator, grain elevator beginning 279' from DER, 26' left of centerline, up to 752' MSL.  
Trees beginning 320' from DER, 448' right of centerline, up to 704' MSL.  
Tree, vehicle on road beginning 506' from DER, 6' right of centerline, up to 721' MSL.  
Trees beginning 870' from DER, 641' right of centerline, up to 727' MSL.  
Trees beginning 2977' from DER, 19' left of centerline, up to 754' MSL. Trees beginning 3124' from DER, 52' right of centerline, up to 744' MSL.

## WAYCROSS, GA

### WAYCROSS-WARE COUNTY (AYS)

#### TAKEOFF MINIMUMS AND (OBSTACLE) DEPARTURE PROCEDURES

AMDT 2 04FEB16 (16035) (FAA)

##### TAKEOFF MINIMUMS:

**Rwy 19**, 500-3 or std. w/min. climb of 230' per NM to 700.

##### TAKEOFF OBSTACLE NOTES:

**Rwy 1**, vehicle on road beginning 66' from DER, 182' right of centerline, up to 15' AGL/147' MSL.  
Poles and trees beginning 934' from DER, 698' right of centerline, up to 100' AGL/253' MSL.  
Gen util 13' from DER, 153' left of centerline, 1' AGL/141' MSL.  
Trees beginning 1964' from DER, 860' left of centerline, up to 100' AGL/242' MSL.  
**Rwy 5**, trees beginning 21' from DER, 63' right of centerline, up to 31' AGL/141' MSL.  
Trees beginning 785' from DER, 8' right of centerline, up to 100' AGL/217' MSL.  
Trees beginning 10' from DER, 282' left of centerline up to 100' AGL/185' MSL.  
Trees beginning 701' from DER, 2' left of centerline, up to 100' AGL/232' MSL.  
**Rwy 13**, trees beginning 11' from DER, 5' right of centerline, up to 100' AGL/250' MSL.  
Trees and poles beginning 658' from DER, 3' left of centerline, up to 100' AGL/237' MSL.  
Catenary 2559' from DER, 886' left of centerline, 78' AGL/216' MSL.  
**Rwy 19**, tower 2.5 NM from DER, 1012' right of centerline, 417' AGL/557' MSL.  
Vehicle on road beginning 115' from DER, 226 right of centerline up to 15' AGL/147' MSL.  
Trees and poles beginning 9' from DER, 47' right of centerline, up to 100' AGL/238' MSL.  
Poles and trees beginning 1092' from DER, 2' left of centerline, up to 100' AGL/233' MSL.  
**Rwy 23**, trees beginning 69' from DER, right and left of centerline, up to 100' AGL/249' MSL.  
**Rwy 31**, tower 55' from DER, 255' left of centerline, 48' AGL/187' MSL.  
Vehicle on road beginning 110' from DER, 364' left of centerline, up to 15' AGL/155' MSL.  
Trees beginning 1741' from DER, 791' left of centerline, up to 100' AGL/216' MSL.  
Trees beginning 2852' from DER, 216' right of centerline, up to 100' AGL/254' MSL.

## WAYNESBORO, GA

### BURKE COUNTY (BXG)

#### TAKEOFF MINIMUMS AND (OBSTACLE) DEPARTURE PROCEDURES

ORIG 30AUG07 (07242) (FAA)

##### TAKEOFF OBSTACLE NOTES:

**Rwy 8**, trees beginning 485' from DER, 129' left of centerline, up to 100' AGL/440' MSL.  
Trees beginning 2228' from DER, 82' right of centerline, up to 100' AGL/409' MSL.  
**Rwy 26**, trees beginning 3053' from DER, 800' left of centerline, up to 100' AGL/439' MSL.  
Trees beginning 3843' from DER, 416' right of centerline, up to 100' AGL/429' MSL.

# TAKEOFF MINIMUMS, (OBSTACLE) DEPARTURE PROCEDURES, AND DIVERSE VECTOR AREA (RADAR VECTORS)

24025

SE-4

# TAKEOFF MINIMUMS, (OBSTACLE) DEPARTURE PROCEDURES, AND DIVERSE VECTOR AREA (RADAR VECTORS)

24025

## WETUMPKA, AL

WETUMPKA MUNI (08A)

TAKEOFF MINIMUMS AND (OBSTACLE) DEPARTURE PROCEDURES

ORIG 03JUN10 (10154) (FAA)

TAKEOFF MINIMUMS:

**Rwys 18, 36**, NA-Environmental.

**Rwy 27**, 500-3 with minimum climb of 220' per NM to 800 or standard with minimum climb of 450' per NM to 600 or 1000-2½ for climb in visual conditions.

DEPARTURE PROCEDURE:

**Rwy 27**, for climb in visual conditions cross Wetumpka Muni airport at or above 1000 before proceeding on course.

TAKEOFF OBSTACLE NOTES:

**Rwy 9**, vehicle on roadway 471' from DER, 591' left of centerline, up to 15' AGL/214' MSL.

Trees beginning 540' from DER, left and right of centerline, up to 100' AGL/299' MSL.

**Rwy 27**, building 453' from DER, 434' right of centerline, 25' AGL/224' MSL.

Vehicles on roadway 617' from DER, left and right of centerline, up to 15' AGL/214' MSL.

Trees beginning 1314' from DER, 50' right of centerline, up to 100' AGL/309' MSL.

Power lines beginning 2243' from DER, left and right of centerline, up to 88' AGL/322' MSL.

Trees beginning 3454' from DER, left and right of centerline, up to 100' AGL/409' MSL.

Rising terrain and trees beginning 1.7 miles from DER, left and right of centerline, up to 200' AGL/639' MSL.

## WINDER, GA

BARROW COUNTY (WDR)

TAKEOFF MINIMUMS AND (OBSTACLE) DEPARTURE PROCEDURES

AMDT 1 08APR10 (10098) (FAA)

TAKEOFF MINIMUMS:

**Rwy 23**, std. w/min. climb of 210' per NM to 3100 or 900-2½ for climb in visual conditions.

**Rwy 31**, 300-1¼ or std. w/ min. climb of 205' per NM to 1300, or alternatively, with std. takeoff minimums and a normal 200' NM climb gradient, takeoff must occur no later than 1300' prior to DER.

DEPARTURE PROCEDURE:

**Rwy 23**, for climb in visual conditions: cross Barrow County airport at or above 1700' MSL before proceeding on course.

TAKEOFF OBSTACLE NOTES:

**Rwy 5**, multiple trees beginning 6' from DER, 41' left of centerline, up to 48' AGL/982' MSL.

Multiple trees beginning 43' from DER, 24' right of centerline, up to 74' AGL/973' MSL.

**Rwy 13**, multiple trees/poles/signs beginning 835' from DER, 16' left of centerline, up to 74' AGL/983' MSL.

Multiple trees/poles beginning 82' from DER, 8' right of centerline, up to 59' AGL/968' MSL.

**Rwy 23**, multiple trees beginning 31' from DER, 344' left of centerline, up to 100' AGL/1041' MSL.

Multiple trees beginning 487' from DER, 279' right of centerline, up to 100' AGL/1059' MSL.

**Rwy 31**, multiple trees beginning 493' from DER, 30' left of centerline, up to 100' AGL/1139' MSL.

Multiple trees beginning 63' from DER, 19' right of centerline, up to 57' AGL/1000' MSL.

Localizer antenna 295' from DER, on centerline 8' AGL/943' MSL.

Tree 7804' from DER, 1990' left of centerline, 100' AGL/1139' MSL.

22 FEB 2024 to 21 MAR 2024

22 FEB 2024 to 21 MAR 2024

# TAKEOFF MINIMUMS, (OBSTACLE) DEPARTURE PROCEDURES, AND DIVERSE VECTOR AREA (RADAR VECTORS)

24025

SE-4

# BOKRT THREE ARRIVAL (RNAV)

ATLANTA, GEORGIA

ATLANTA APP CON  
 119.8 354.125  
 FTY ATIS  
 120.175  
 LZU ATIS  
 132.275  
 KMGE ATIS ★  
 269.5  
 PDK ATIS  
 128.4  
 RYY ATIS  
 128.125

CHEROKEE COUNTY RGNL

LEE GILMER MEML

CARTERSVILLE

KENZI

PAULDING NORTHWEST ATLANTA

BRTEN

BAPPY

COBB COUNTY INTL/MCCOLLUM FLD

GWINNETT COUNTY/BRISCOE FLD

DOBBINS ARB

DEKALB-PEACHTREE

FULTON COUNTY EXEC/CHARLIE BROWN FLD

PONGG

NOTE: RADAR required.  
 NOTE: RNAV 1.  
 NOTE: GPS required.

PINGG

BOKRT

Turbojets: Expect 11000 250K  
 Turboprops: Expect 9000 or 7000  
 Reciprocating: Expect 7000 or 5000

### ARRIVAL ROUTE DESCRIPTION

#### KEEPS TRANSITION (KEEPS.BOKRT3):

From BOKRT on track 017° to PINGG, then on track 017° to PONGG, then on track 040° to BRTEN, then on track 075° to BAPPY, then on track 082° to KENZI, then on track 082°. Expect RADAR vectors to final approach course.

LOST COMMUNICATIONS: Cross BOKRT at or below 11000, cross PONGG at or below 7000, cross KENZI at 5000; after KENZI proceed direct to the IAF for desired approach to filed airport.

NOTE: Chart not to scale.

# BOKRT THREE ARRIVAL (RNAV)

ATLANTA, GEORGIA

# BUKHD THREE ARRIVAL (RNAV)

ATLANTA, GEORGIA

ATLANTA APP CON  
 121.0 268.7  
 FTY ATIS  
 120.175  
 LZU ATIS  
 132.275  
 ★ KMGE ATIS  
 269.5  
 PDK ATIS  
 128.4  
 RYY ATIS  
 128.125

**ARRIVAL ROUTE DESCRIPTION**

RIZZZ TRANSITION (RIZZZ.BUKHD3)  
WUDYA TRANSITION (WUDYA.BUKHD3)

LANDING KHMP/KFFC/KRYY/KFTY/K6A2/KCCO/  
 KVPC/KPUJ/KMGE: From HLNDS on track 147°  
 to BUKHD, then on track 152° to DRINC, then on track  
 152°. Expect RADAR vectors to final approach course.

LANDING KPDK/KD73/KLZU/KCVC: From HLNDS  
 on track 147° to BUKHD, then on track 112° to  
 CCOKE, then on track 112°. Expect RADAR vectors to final approach course.

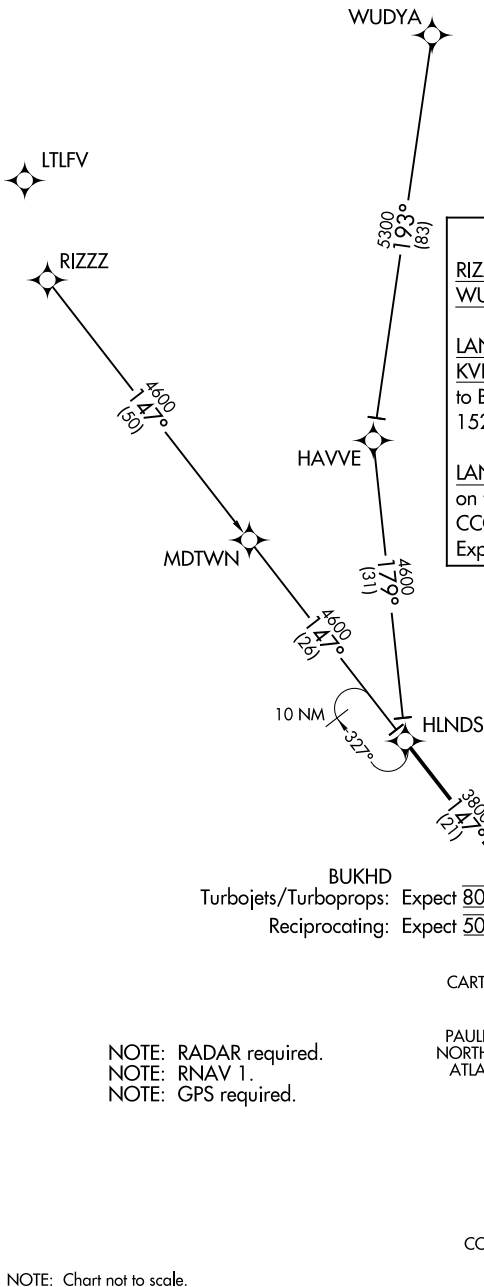

SE-4, 22 FEB 2024 to 21 MAR 2024

SE-4, 22 FEB 2024 to 21 MAR 2024

NOTE: RADAR required.  
 NOTE: RNAV 1.  
 NOTE: GPS required.

NOTE: Chart not to scale.

# BUKHD THREE ARRIVAL (RNAV)

(HLNDS.BUKHD3) 16JUL20

ATLANTA, GEORGIA

(AWSON.DEHAN3) 21336

AL-469 (FAA)

# DEHAN THREE ARRIVAL (RNAV)

ATLANTA, GEORGIA

ATLANTA APP CON  
 126.975 239.275  
 FTY ATIS  
 120.175  
 LZU ATIS  
 132.275  
 KMGE ATIS ★  
 269.5  
 PDK ATIS  
 128.4  
 RYY ATIS  
 128.125

NOTE: RADAR required  
 NOTE: RNAV 1  
 NOTE: GPS required

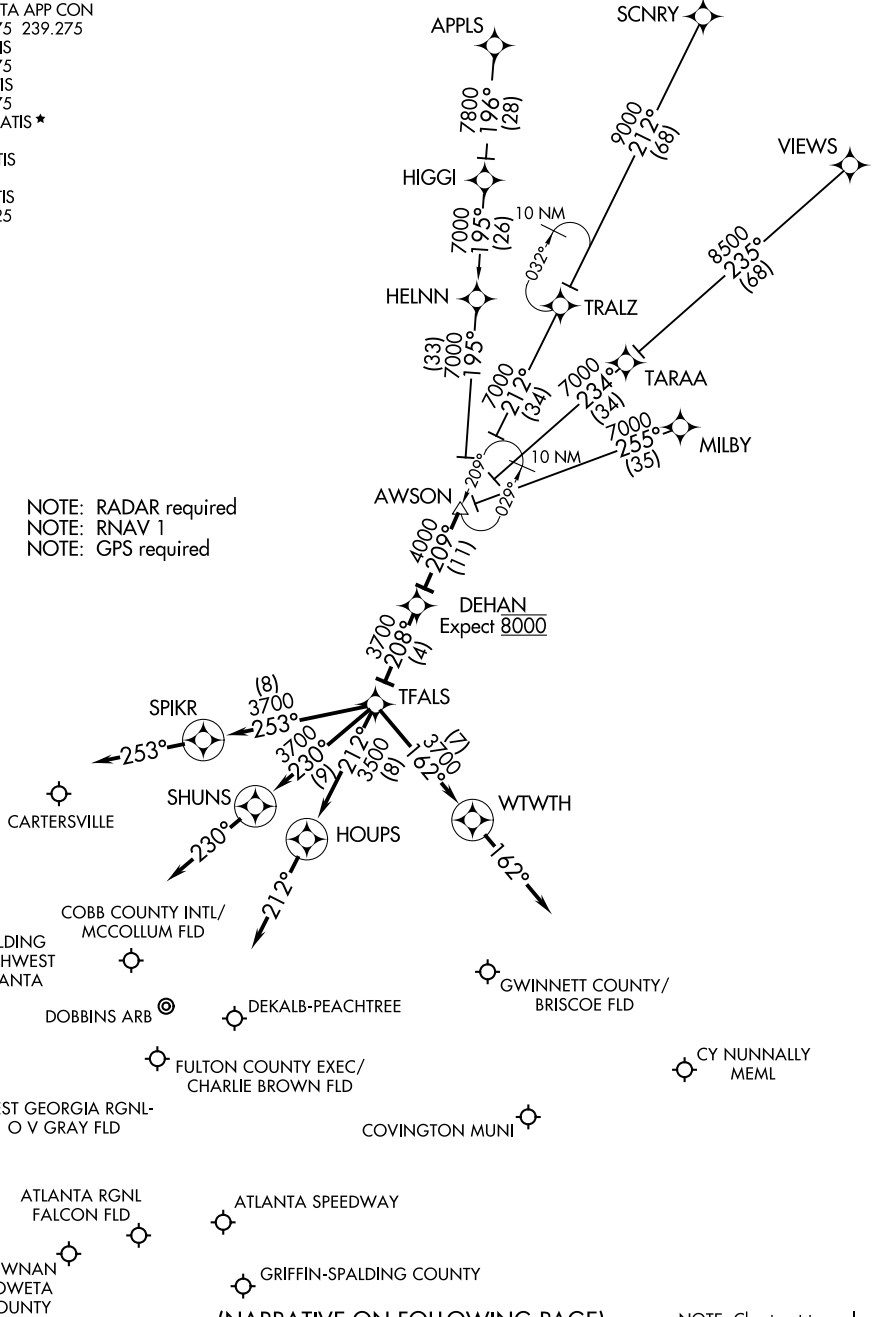

SE-4, 22 FEB 2024 to 21 MAR 2024

SE-4, 22 FEB 2024 to 21 MAR 2024

(NARRATIVE ON FOLLOWING PAGE)

NOTE: Chart not to scale.

# DEHAN THREE ARRIVAL (RNAV)

(AWSON.DEHAN3) 16JUL20

ATLANTA, GEORGIA

ARRIVAL ROUTE DESCRIPTION

- APPLS TRANSITION (APPLS.DEHAN3)
- MILBY TRANSITION (MILBY.DEHAN3)
- SCNRY TRANSITION (SCNRY.DEHAN3)
- VIEWS TRANSITION (VIEWS.DEHAN3)

LANDING KHMP/KD73/KLZU/K6A2/KCVC: From AWSON on track 209° to DEHAN, then on track 208° to TFALS, then on track 162° to WTWTH, then on track 162°. Expect RADAR vectors to final approach course.

LANDING KPDK/KFFC/KCCO: From AWSON on track 209° to DEHAN, then on track 208° to TFALS, then on track 212° to HOUPS, then on track 212°. Expect RADAR vectors to final approach course.

LANDING KRYV/KVPC/KPUJ/KCTJ: From AWSON on track 209° to DEHAN, then on track 208° to TFALS, then on track 253° to SPIKR, then on track 253°. Expect RADAR vectors to final approach course.

LANDING KFTY/KMGE: From AWSON on track 209° to DEHAN, then on track 208° to TFALS, then on track 230° to SHUNS, then on track 230°. Expect RADAR vectors to final approach course.

SE-4, 22 FEB 2024 to 21 MAR 2024

SE-4, 22 FEB 2024 to 21 MAR 2024



SWTTEE TWO ARRIVAL (RNAV)  
(SWTTEE, SWTTEE2) 21MAY20

(SWTTEE, SWTTEE2) 21336  
SWTTEE TWO ARRIVAL (RNAV)

ATLANTA APP CON  
126.975 257.9  
FTY ATIS  
120.175  
LZU ATIS  
132.275  
KMGE ATIS\*  
269.5  
PDK ATIS  
128.4  
RYY ATIS  
128.125

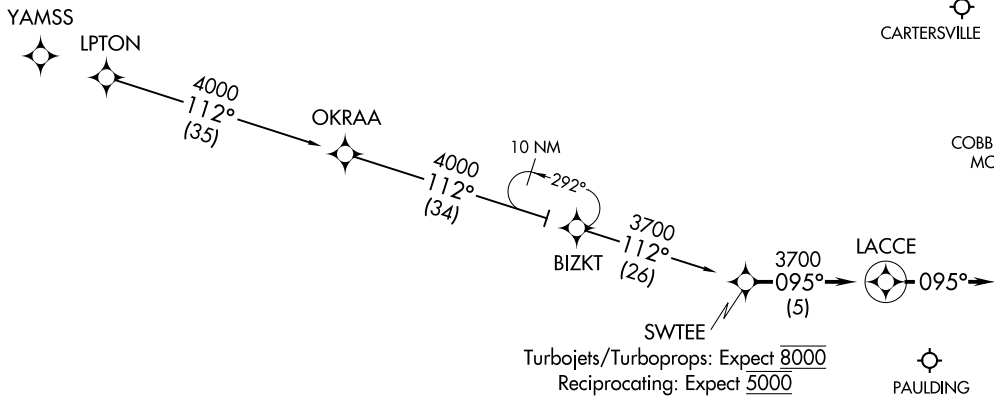

NOTE: RADAR required.  
NOTE: RNAV 1.  
NOTE: GPS required.

ARRIVAL ROUTE DESCRIPTION

BIZKT TRANSITION (BIZKT.SWTTEE2)  
LPTON TRANSITION (LPTON.SWTTEE2)

From SWTTEE on track 095° to LACCE, then on track 095°.  
Expect RADAR vectors to final approach course.



ATLANTA, GEORGIA

ATLANTA, GEORGIA

A1-469 (FAA)

NOTE: Chart not to scale.

WRGNZ THREE ARRIVAL (RNAV)  
(WRGNZ.WRGNZ3) 16JUL20

(WRGNZ.WRGNZ3) 21336  
WRGNZ THREE ARRIVAL (RNAV)

AL-469 (FAA)

ATLANTA APP CON  
128.575 343.675  
FTY ATIS  
120.175  
LZU ATIS  
132.275  
\*KMGE ATIS  
269.5  
PDK ATIS  
128.4  
RYY ATIS  
128.125

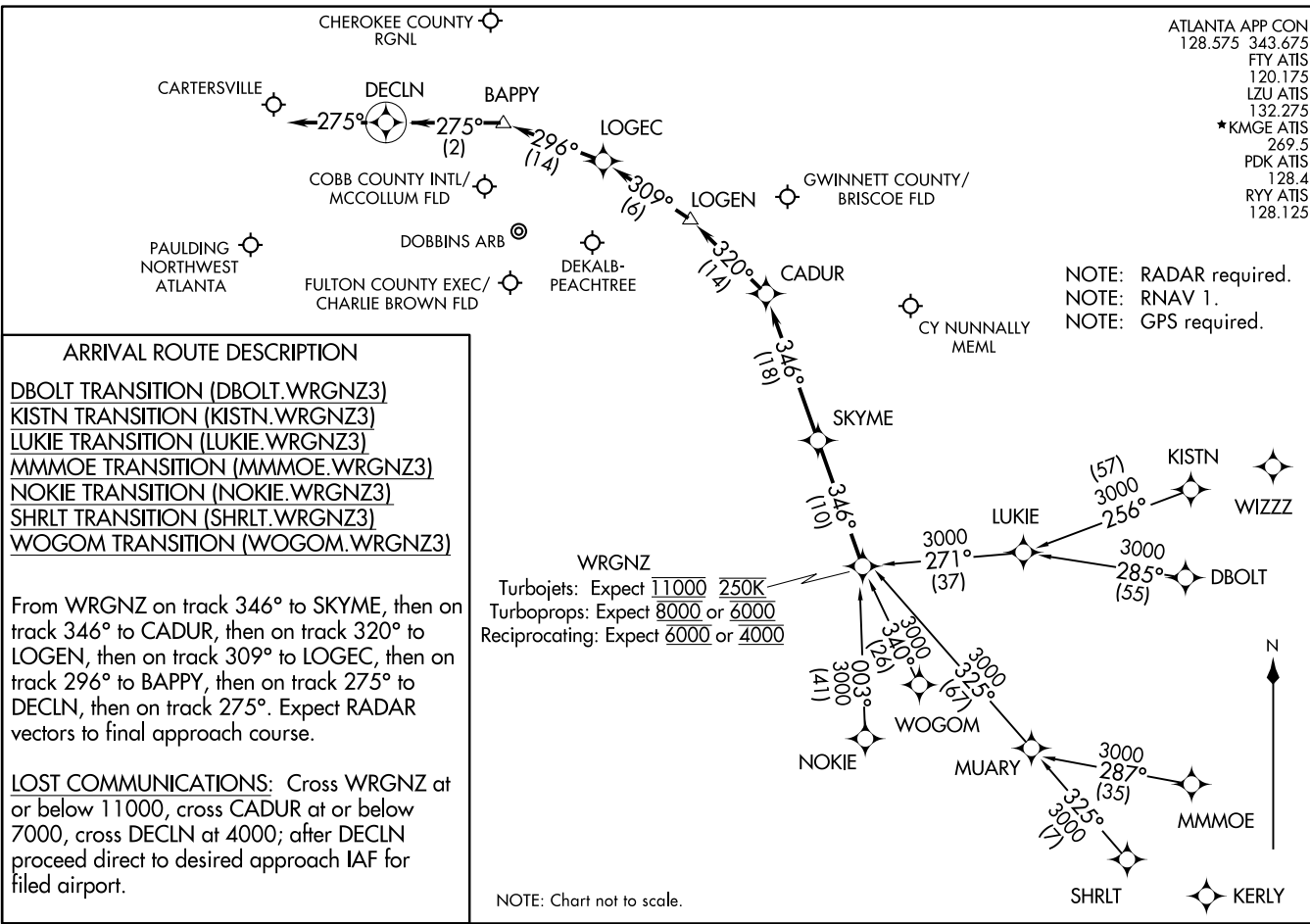

ATLANTA, GEORGIA

ATLANTA, GEORGIA